



# WS/WE100-2P4439

W100-2

MINIATURE PHOTOELECTRIC SENSORS

**SICK**  
Sensor Intelligence.



Illustration may differ



## Ordering information

Type	Part no.
WS/WE100-2P4439	6052368

**Included in delivery:** BEF-W100-A (2)

Other models and accessories → [www.sick.com/W100-2](http://www.sick.com/W100-2)

## Detailed technical data

### Features

<b>Functional principle</b>	Through-beam photoelectric sensor
<b>Dimensions (W x H x D)</b>	11 mm x 31 mm x 20 mm
<b>Housing design (light emission)</b>	Rectangular
<b>Sensing range max.</b>	0 m ... 33 m
<b>Sensing range</b>	0 m ... 20 m
<b>Type of light</b>	Visible red light
<b>Light source</b>	LED <sup>1)</sup>
<b>Light spot size (distance)</b>	Ø 850 mm (12 m)
<b>Wave length</b>	632 nm
<b>Adjustment</b>	Potentiometer, 270° (Sensitivity)

<sup>1)</sup> Average service life: 100,000 h at T<sub>U</sub> = +25 °C.

### Mechanics/electronics

<b>Supply voltage</b>	10 V DC ... 30 V DC <sup>1)</sup>
<b>Ripple</b>	± 10 % <sup>2)</sup>
<b>Power consumption, sender</b>	≤ 15 mA <sup>3)</sup>
<b>Power consumption, receiver</b>	≤ 20 mA <sup>3)</sup>
<b>Switching output</b>	PNP
<b>Switching mode</b>	Light/dark switching

<sup>1)</sup> Limit values.

<sup>2)</sup> May not exceed or fall below U<sub>v</sub> tolerances.

<sup>3)</sup> Without load.

<sup>4)</sup> Signal transit time with resistive load.

<sup>5)</sup> With light/dark ratio 1:1.

<sup>6)</sup> A = V<sub>S</sub> connections reverse-polarity protected.

<sup>7)</sup> B = output reverse-polarity protected.

<sup>8)</sup> D = outputs overcurrent and short-circuit protected.

<b>Switching mode selector</b>	Selectable via light/dark rotary switch
<b>Signal voltage PNP HIGH/LOW</b>	$U_V - 1,8 \text{ V} / \text{ca. } 0 \text{ V}$
<b>Output current <math>I_{\text{max}}</math></b>	$\leq 100 \text{ mA}$
<b>Response time</b>	$\leq 0,5 \text{ ms}^{4)}$
<b>Switching frequency</b>	$1,000 \text{ Hz}^{5)}$
<b>Connection type</b>	Male connector M8, 4-pin
<b>Circuit protection</b>	A <sup>6)</sup> B <sup>7)</sup> D <sup>8)</sup>
<b>Protection class</b>	III
<b>Housing material</b>	Plastic, ABS/PC/POM
<b>Optics material</b>	Plastic, PMMA
<b>Enclosure rating</b>	IP67
<b>Items supplied</b>	2 Stainless steel mounting brackets (1.4301/304) BEF-W100-A
<b>Ambient operating temperature</b>	$-25 \text{ }^\circ\text{C} \dots +55 \text{ }^\circ\text{C}$
<b>Ambient temperature, storage</b>	$-40 \text{ }^\circ\text{C} \dots +70 \text{ }^\circ\text{C}$

1) Limit values.

2) May not exceed or fall below  $U_V$  tolerances.

3) Without load.

4) Signal transit time with resistive load.

5) With light/dark ratio 1:1.

6) A =  $V_S$  connections reverse-polarity protected.

7) B = output reverse-polarity protected.

8) D = outputs overcurrent and short-circuit protected.

## Safety-related parameters

<b>MTTF<sub>D</sub></b>	565 years
<b>DC<sub>avg</sub></b>	0 %

## Classifications

<b>eCl@ss 5.0</b>	27270901
<b>eCl@ss 5.1.4</b>	27270901
<b>eCl@ss 6.0</b>	27270901
<b>eCl@ss 6.2</b>	27270901
<b>eCl@ss 7.0</b>	27270901
<b>eCl@ss 8.0</b>	27270901
<b>eCl@ss 8.1</b>	27270901
<b>eCl@ss 9.0</b>	27270901
<b>eCl@ss 10.0</b>	27270901
<b>eCl@ss 11.0</b>	27270901
<b>eCl@ss 12.0</b>	27270901
<b>ETIM 5.0</b>	EC002716
<b>ETIM 6.0</b>	EC002716
<b>ETIM 7.0</b>	EC002716

<b>ETIM 8.0</b>	EC002716
<b>UNSPSC 16.0901</b>	39121528

### Connection diagram

Cd-057

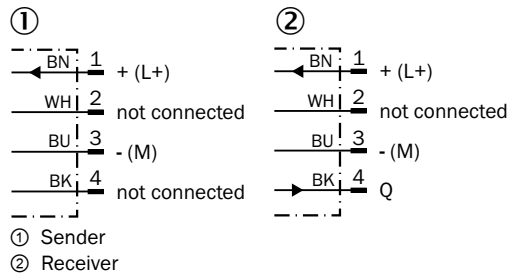

### Characteristic curve

WS/WE100-2

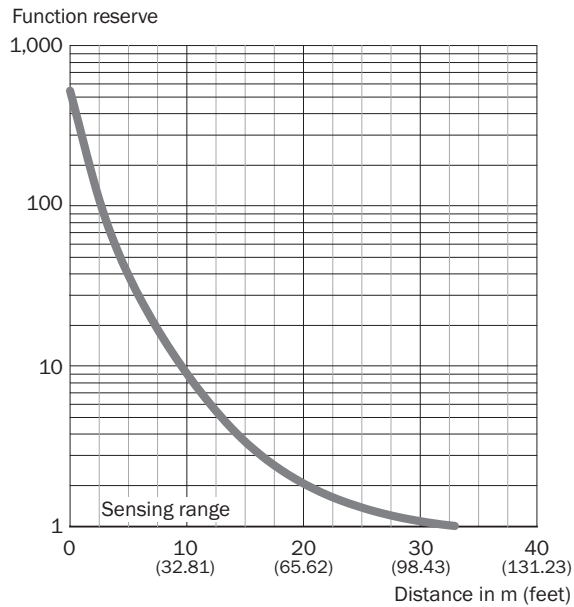

## Light spot size

Light spot size

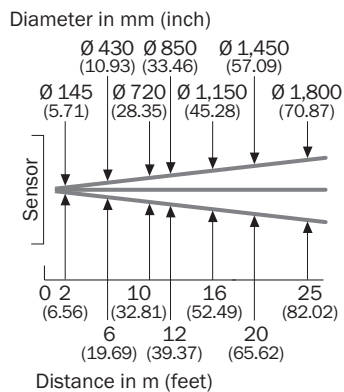

## Sensing range diagram

WS/WE100-2

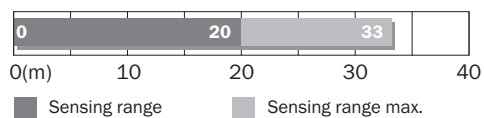

## Adjustments

W100-2

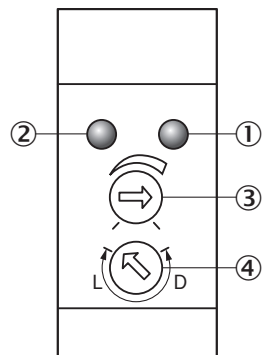

- ① LED indicator orange: switching output active
- ② LED indicator green: power on
- ③ Sensing range adjustment: potentiometer
- ④ Light/ dark rotary switch: L = light switching, D = dark switching

**Dimensional drawing** (Dimensions in mm (inch))



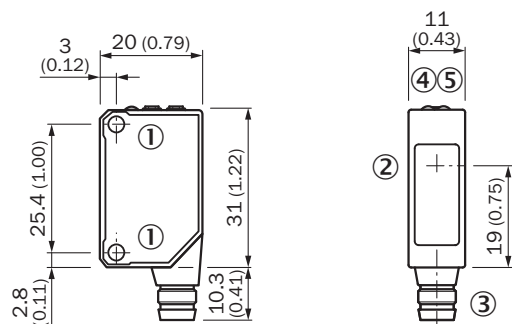

WS/WE100



- ① Threaded mounting hole M3
- ② Center of optical axis
- ③ Connection
- ④ LED indicator orange: switching output active
- ⑤ LED indicator green: power on

**Recommended accessories**

Other models and accessories → [www.sick.com/W100-2](http://www.sick.com/W100-2)

	<b>Brief description</b>	<b>Type</b>	<b>Part no.</b>
<b>Mounting brackets and plates</b>			
	Mounting bracket for wall mounting, stainless steel, mounting hardware included	BEF-W100-A	5311520
	Mounting bracket for floor mounting, steel, zinc coated, mounting hardware included	BEF-W100-B	5311521
<b>Plug connectors and cables</b>			
	Head A: female connector, M8, 4-pin, straight, A-coded Head B: Flying leads Cable: Sensor/actuator cable, PVC, unshielded, 5 m	YF8U14-050VA3XLEAX	2095889
	Head A: male connector, M8, 4-pin, straight Cable: unshielded	STE-0804-G	6037323

## SICK AT A GLANCE

SICK is one of the leading manufacturers of intelligent sensors and sensor solutions for industrial applications. A unique range of products and services creates the perfect basis for controlling processes securely and efficiently, protecting individuals from accidents and preventing damage to the environment.

We have extensive experience in a wide range of industries and understand their processes and requirements. With intelligent sensors, we can deliver exactly what our customers need. In application centers in Europe, Asia and North America, system solutions are tested and optimized in accordance with customer specifications. All this makes us a reliable supplier and development partner.

Comprehensive services complete our offering: SICK LifeTime Services provide support throughout the machine life cycle and ensure safety and productivity.

For us, that is “Sensor Intelligence.”

## WORLDWIDE PRESENCE:

Contacts and other locations –[www.sick.com](http://www.sick.com)