

Triple Supply Monitor and μ P Supervisor with Adjustable Reset and Watchdog Timer

FEATURES

- **Monitors Three Inputs Simultaneously**
 LTC1726-5: 5V, 3.3V and ADJ
 LTC1726-2.5: 2.5V, 3.3V and ADJ
- $\pm 1.5\%$ Threshold Accuracy Over Temperature
- **Low Supply Current: 16 μ A Typ**
- **Adjustable Reset Timeout**
- **Adjustable Watchdog Timeout**
- Active Low Open-Drain Reset Output
- Power Supply Glitch Immunity
- Guaranteed $\overline{\text{RESET}}$ for $V_{CC3} \geq 1\text{V}$ or $V_{CC25}/V_{CC5} \geq 1\text{V}$
- MS8 and SO-8 Packages

APPLICATIONS

- Desktop Computers
- Notebook Computers
- Intelligent Instruments
- Portable Battery-Powered Equipment
- Network Servers

DESCRIPTION

The LTC[®]1726 is a triple supply monitor and microprocessor supervisory circuit with adjustable reset and watchdog functions intended for systems with multiple supply voltages. The part has a common open-drain reset output with an adjustable delay. The reset and watchdog time-out periods are both adjustable using external capacitors.

Tight 1.5% accuracy specifications and glitch immunity ensure reliable reset operation without false triggering.

The $\overline{\text{RST}}$ output is guaranteed to be in the correct state for V_{CC5}/V_{CC25} or V_{CC3} down to 1V. The LTC1726 may also be configured to monitor any one or two V_{CC} inputs instead of three, depending on system requirements.

The low (16 μ A typical) supply current makes the LTC1726 ideal for power-conscious systems.

LT, LTC and LT are registered trademarks of Linear Technology Corporation.

TYPICAL APPLICATIONS

A 3.3V, 5V and 1.8V Monitor

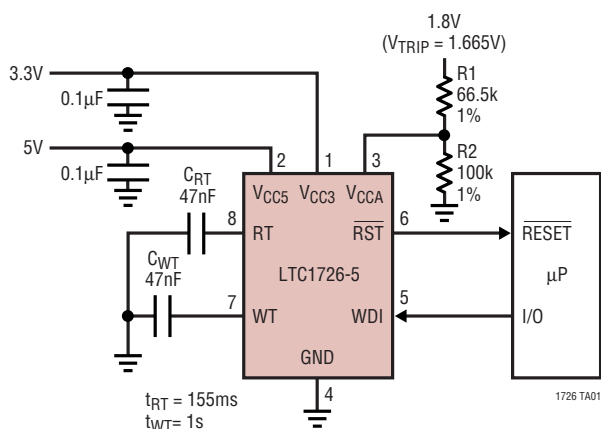

A 3.3V, 2.5V and 1.8V Monitor

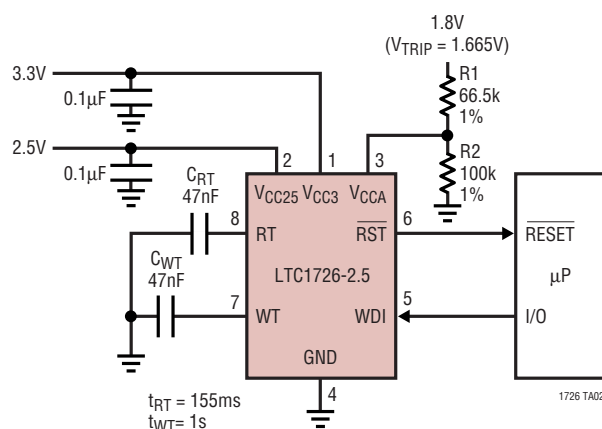

ABSOLUTE MAXIMUM RATINGS (Notes 1, 2)

Terminal Voltage	RT, WT	-0.3V to 7V
$V_{CC3}, V_{CC5}/V_{CC25}, V_{CCA}$	Operating Temperature Range (Note 3) ..	-40°C to 85°C
RST	Storage Temperature Range	-65°C to 150°C
WDI	Lead Temperature (Soldering, 10 sec)	300°C

PACKAGE/ORDER INFORMATION

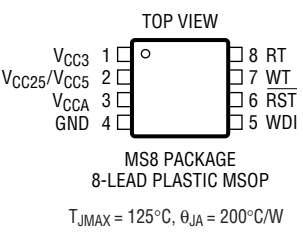
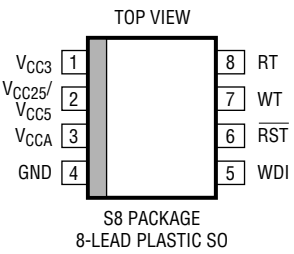
 <p>MS8 PACKAGE 8-LEAD PLASTIC MSOP $T_{JMAX} = 125^{\circ}C, \theta_{JA} = 200^{\circ}C/W$</p>	ORDER PART NUMBER	 <p>S8 PACKAGE 8-LEAD PLASTIC SO $T_{JMAX} = 125^{\circ}C, \theta_{JA} = 150^{\circ}C/W$</p>	ORDER PART NUMBER
	LTC1726EMS8-2.5 LTC1726EMS8-5		LTC1726ES8-2.5 LTC1726ES8-5 LTC1726IS8-2.5 LTC1726IS8-5
	MS8 PART MARKING		S8 PART MARKING
	LTKZ LTLA		172625 17265 726125 172615

Consult LTC Marketing for parts specified with wider operating temperature ranges.

ELECTRICAL CHARACTERISTICS The ● denotes specifications which apply over the full operating temperature range, otherwise specifications are at $T_A = 25^{\circ}C$. $V_{CC3} = 3.3V$, $V_{CC5} = 5V$, $V_{CC25} = 2.5V$, $V_{CCA} = V_{CC3}$ unless otherwise noted.

SYMBOL	PARAMETER	CONDITIONS	MIN	TYP	MAX	UNITS
V_{RT3}	Reset Threshold V_{CC3}	V_{CC3} Input Threshold	● 3.036	3.085	3.135	V
V_{RT5}	Reset Threshold V_{CC5}	V_{CC5} Input Threshold (5V Version)	● 4.600	4.675	4.750	V
V_{RT25}	Reset Threshold V_{CC25}	V_{CC25} Input Threshold (2.5V Version)	● 2.300	2.337	2.375	V
V_{RTA}	Reset Threshold V_{CCA}	V_{CCA} Input Threshold	● 0.985	1.000	1.015	V
V_{CC}	V_{CC3} or V_{CC5} Operating Voltage	RST in Correct Logic State	● 1		7	V
I_{VCC3}	V_{CC3} Supply Current	$V_{CC5}/V_{CC25} > V_{CC3}$ $V_{CC5}/V_{CC25} < V_{CC3}, V_{CC3} = 3.3V$	●	1	2	μA
I_{VCC5}	V_{CC5} Supply Current	$V_{CC5} = 5V$	●	16	30	μA
I_{VCC25}	V_{CC25} Supply Current	$V_{CC25} < V_{CC3}, V_{CC25} = 2.5V$ (Note 4)	●	1	2	μA
I_{VCCA}	V_{CCA} Input Current	$V_{CCA} = 1V$	● -15	0	15	nA
	RT Charge Current Out	$V_{RT} = 0V$	● 1.4	2	2.6	μA
	WT Charge Current Out	$V_{WT} = 0V$	● 1.4	2	2.6	μA
	RT Discharge Current Out	$V_{RT} = 1.3V$	● 14	20	26	μA
	WT Discharge Current Out	$V_{WT} = 1.3V$	● 14	20	26	μA
Δt_{RT}	Reset Time-Out Period Variation	$C_{RT} = 1500pF$ Deviation from $t_{RT} = 5ms$ (Note 5)	● -30	0	30	%
t_{UV}	V_{CC} Undervoltage Detect to RST	$V_{CC25}/V_{CC5}, V_{CC3}$ or V_{CCA} Less Than Reset Threshold V_{RT} by More Than 1%		130		μs

1726fa

ELECTRICAL CHARACTERISTICS The ● denotes specifications which apply over the full operating temperature range, otherwise specifications are at $T_A = 25^\circ\text{C}$. $V_{CC3} = 3.3\text{V}$, $V_{CC5} = 5\text{V}$, $V_{CC25} = 2.5\text{V}$, $V_{CCA} = V_{CC3}$ unless otherwise noted.

SYMBOL	PARAMETER	CONDITIONS	MIN	TYP	MAX	UNITS	
V_{OH}	RST Output Voltage High (Note 6)	$I_{SOURCE} = 1\mu\text{A}$	● $V_{CC3} - 1$			V	
V_{OL}	RST Output Voltage Low	$I_{SINK} = 2.5\text{mA}$, $V_{CC5}/V_{CC25} = 0\text{V}$ $I_{SINK} = 100\mu\text{A}$, $V_{CC3} = 1\text{V}$, $V_{CC5}/V_{CC25} = 0\text{V}$ $I_{SINK} = 100\mu\text{A}$, $V_{CC3} = 0\text{V}$, $V_{CC5}/V_{CC25} = 1\text{V}$ $I_{SINK} = 100\mu\text{A}$, $V_{CC3} = 1\text{V}$, $V_{CC5}/V_{CC25} = 1\text{V}$	●	0.15	0.4	V	
			●	0.05	0.3	V	
			●	0.05	0.3	V	
			●	0.05	0.3	V	
V_{IH}	WDI Input Threshold High		●		$0.7 \cdot V_{CC3}$	V	
V_{IL}	WDI Input Threshold Low		●	$0.3 \cdot V_{CC3}$		V	
t_{WP}	WDI Pulse Width		●	40		ns	
Δt_{WT}	Watchdog Time-Out Period Variation	$C_{WT} = 1500\text{pF}$ Deviation from $t_{WT} = 33\text{ms}$ (Note 5)	●	-30	0	30	%
	WDI Leakage Current		●		± 1	μA	
F_{WD}	WDI Input Frequency	$C_{WT} = 1500\text{pf}$, (Note 8) $C_{WT} = 0\text{pF}$, C_{WT} Pin Left Open			2.1	kHz	
					250	kHz	

LTC1726-5 Only

V_{OVR}	V_{CC5} Reset Override Voltage (Note 7)	Override V_{CC5} Ability to Assert $\overline{\text{RST}}$		$V_{CC3} \pm 0.025$		V
-----------	---	--	--	---------------------	--	---

Note 1: Absolute Maximum Ratings are those values beyond which the life of the device may be impaired.

Note 2: All voltage values are with respect to GND.

Note 3: The LTC1726E is guaranteed to meet performance specifications from 0°C to 70°C . Specifications over the -40°C to 85°C operating temperature range are assured by design, characterization and correlation with statistical process controls.

Note 4: Both V_{CC3} and V_{CC25}/V_{CC5} can act as the supply depending on which pin has the greatest potential.

Note 5: Timing measured with respect to $\overline{\text{RST}}$ passing through 1.5V.

Note 6: The output pin $\overline{\text{RST}}$ has a weak internal pull-up to V_{CC3} of typically $6\mu\text{A}$. However, external pull-up resistors may be used when faster rise times are required or for V_{OH} voltages greater than V_{CC3} .

Note 7: The V_{CC5} reset override voltage is valid for an operating range less than approximately 4.15V. Above this point the override is turned off and the V_{CC5} pin functions normally.

Note 8: Guaranteed by design and not subject to test. The maximum frequency at which the WDI pin can be toggled is:

$$F_{WD}(\text{Hz}) = \frac{1}{(315,000\text{V/A}) \cdot (C_{WT}) + 4\mu\text{s}}; C_{WT} \text{ in Farads}$$

Consult factory if WDI frequencies greater than F_{WD} are required.

TYPICAL PERFORMANCE CHARACTERISTICS

V_{CC5} Threshold Voltage vs Temperature (LTC1726-5)

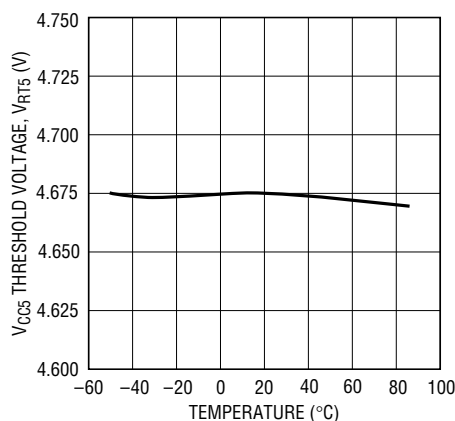

1726 G01

V_{CC3} Threshold Voltage vs Temperature

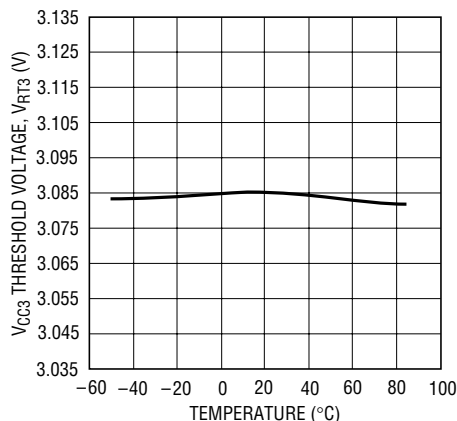

1726 G02

V_{CCA} Threshold Voltage vs Temperature

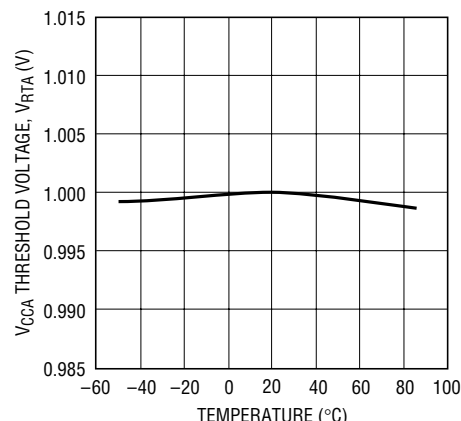

1726 G03

1726fa

TYPICAL PERFORMANCE CHARACTERISTICS

V_{CC25} Threshold Voltage vs Temperature (LTC1726-2.5)

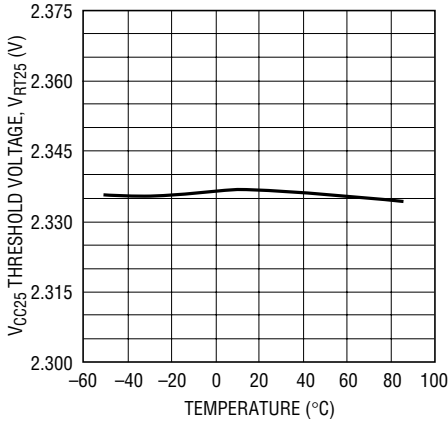

1726 G04

I_{VCC5} vs Temperature (LTC1726-5)

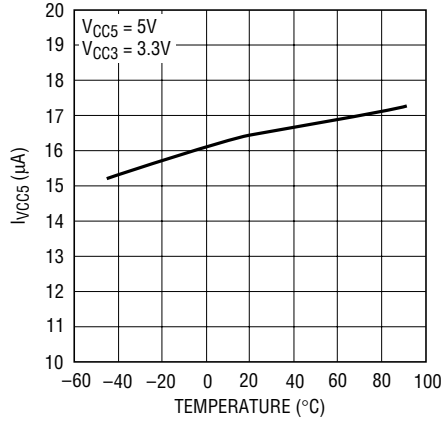

1726 G05

I_{VCC3} vs Temperature (LTC1726-5)

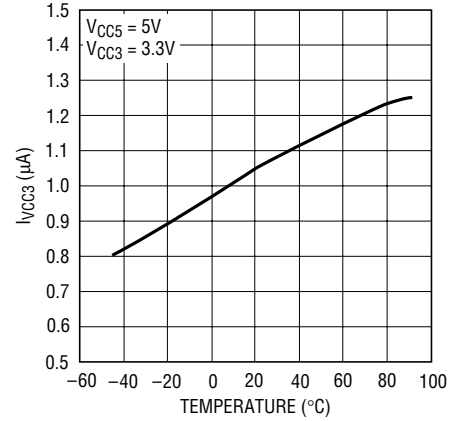

1726 G06

I_{VCC25} vs Temperature (LTC1726-2.5)

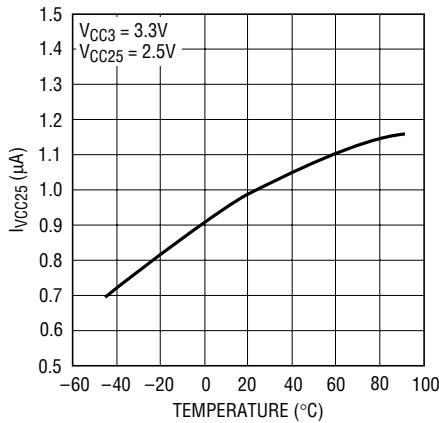

1726 G07

I_{VCC3} vs Temperature (LTC1726-2.5)

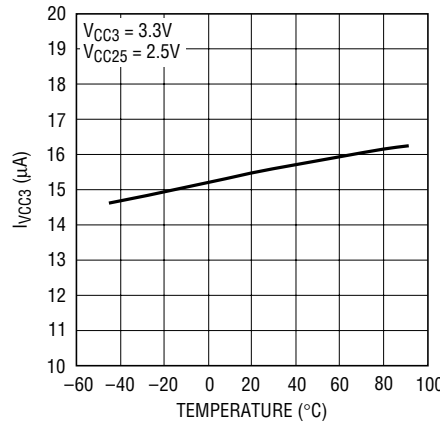

1726 G08

Typical Transient Duration vs Comparator Overdrive

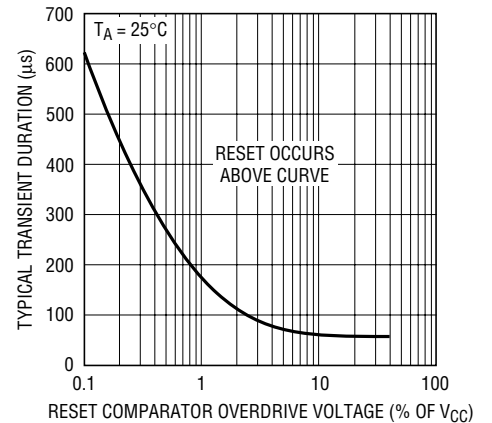

1726 G09

V_{CCA} Input Current vs Input Voltage

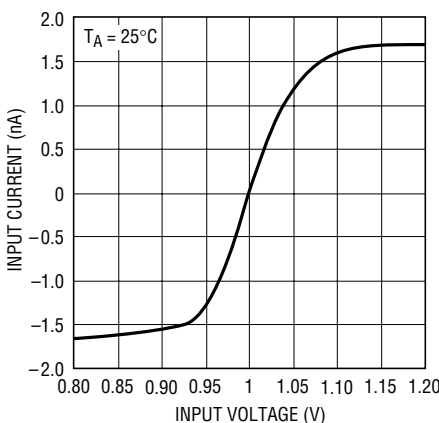

1726 G14

Watchdog Time-Out Period vs Temperature

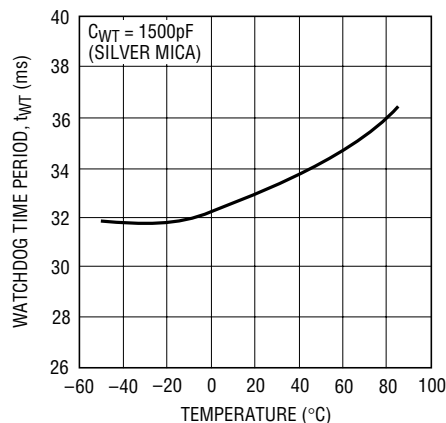

1726 G10

Reset Pulse Width vs Temperature

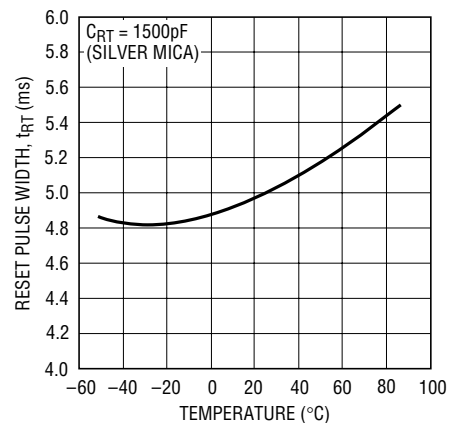

1726 G11

TYPICAL PERFORMANCE CHARACTERISTICS

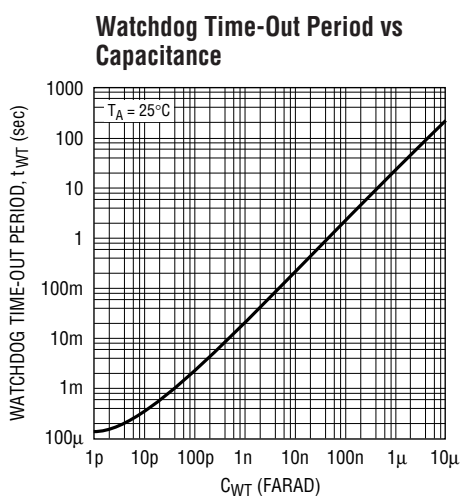

1726 G12

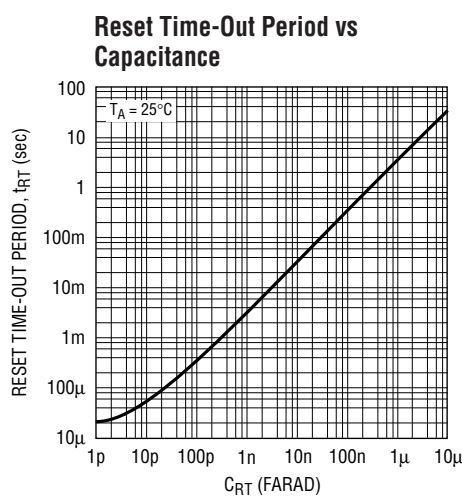

1726 G15

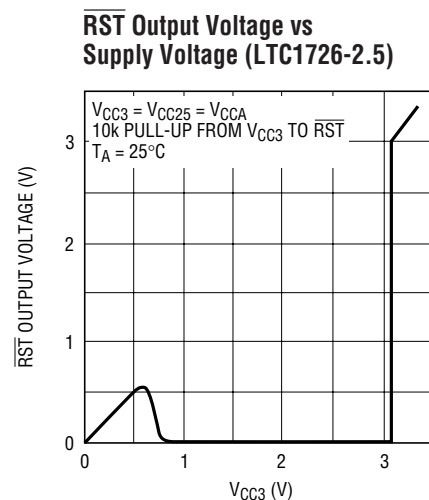

1726 F13

PIN FUNCTIONS

V_{CC3} (Pin 1): 3.3V Sense Input. This pin also supplies power to the part when the voltage on this pin is greater than the voltage on V_{CC25}/V_{CC5} . Bypass this pin to ground with a 0.1 μ F or larger ceramic capacitor.

V_{CC5} (Pin 2): 5V Sense Input (LTC1726-5). This pin also supplies power to the part when the voltage on this pin is greater than the voltage on V_{CC3} . Bypass this pin to ground with a 0.1 μ F or larger ceramic capacitor.

V_{CC25} (Pin 2): 2.5V Sense Input (LTC1726-2.5). This pin also supplies power to the part when the voltage on this pin is greater than the voltage on V_{CC3} . Bypass this pin to ground with a 0.1 μ F or larger ceramic capacitor.

V_{CCA} (Pin 3): 1V Sense, High Impedance Input. If unused it can be tied to either V_{CC3} , V_{CC5} or V_{CC25} .

GND (Pin 4): Ground.

WDI (Pin 5): Watchdog Input. A logic input whose rising or falling edge must occur on this pin within the selected watchdog time-out period or a reset pulse will occur. The watchdog time-out period is set by the value of the capacitor that is placed on the WT pin. The rising or falling edge of this pin clears the voltage on the WT capacitor, preventing a reset pulse from occurring. If the watchdog

timer is not cleared, a reset pulse will occur. The watchdog timer is cleared during a reset and restarts when the reset is deasserted. When disabling the watchdog function, this pin should be connected to either V_{CC3} or ground and WT must be grounded.

\overline{RST} (Pin 6): Reset Logic Output. Active low, open-drain logic output with weak pull-up to V_{CC3} . Asserted when one or more of the supplies are below trip thresholds. After all supplies become valid, the reset remains asserted for the period set by the capacitor on the RT pin. The watchdog timer can also trigger the reset whenever the watchdog time-out period is exceeded. This pin can be pulled up greater than V_{CC3} when interfacing to 5V logic.

WT (Pin 7): Watchdog Time-Out Input. Place a capacitor between this pin and ground to adjust the watchdog time-out period. To determine the watchdog time-out period:

$$t_{WT} = 21.8 \cdot C_{WT}$$

with t_{WT} in μ s and C_{WT} in pF. As an example, a 47nF capacitor will generate a 1s watchdog time-out period. The watchdog function can be disabled by connecting this pin to ground.

1726fa

PIN FUNCTIONS

RT (Pin 8): Reset Time-Out Input. Place a capacitor between this pin and ground to adjust the reset time-out period. To determine the reset time-out period:

$$t_{RT} = 3.30 \cdot C_{RT}$$

with t_{RT} in μs and C_{RT} in pF. As an example, a 47nF capacitor will generate a 155ms watchdog time-out period.

BLOCK DIAGRAM

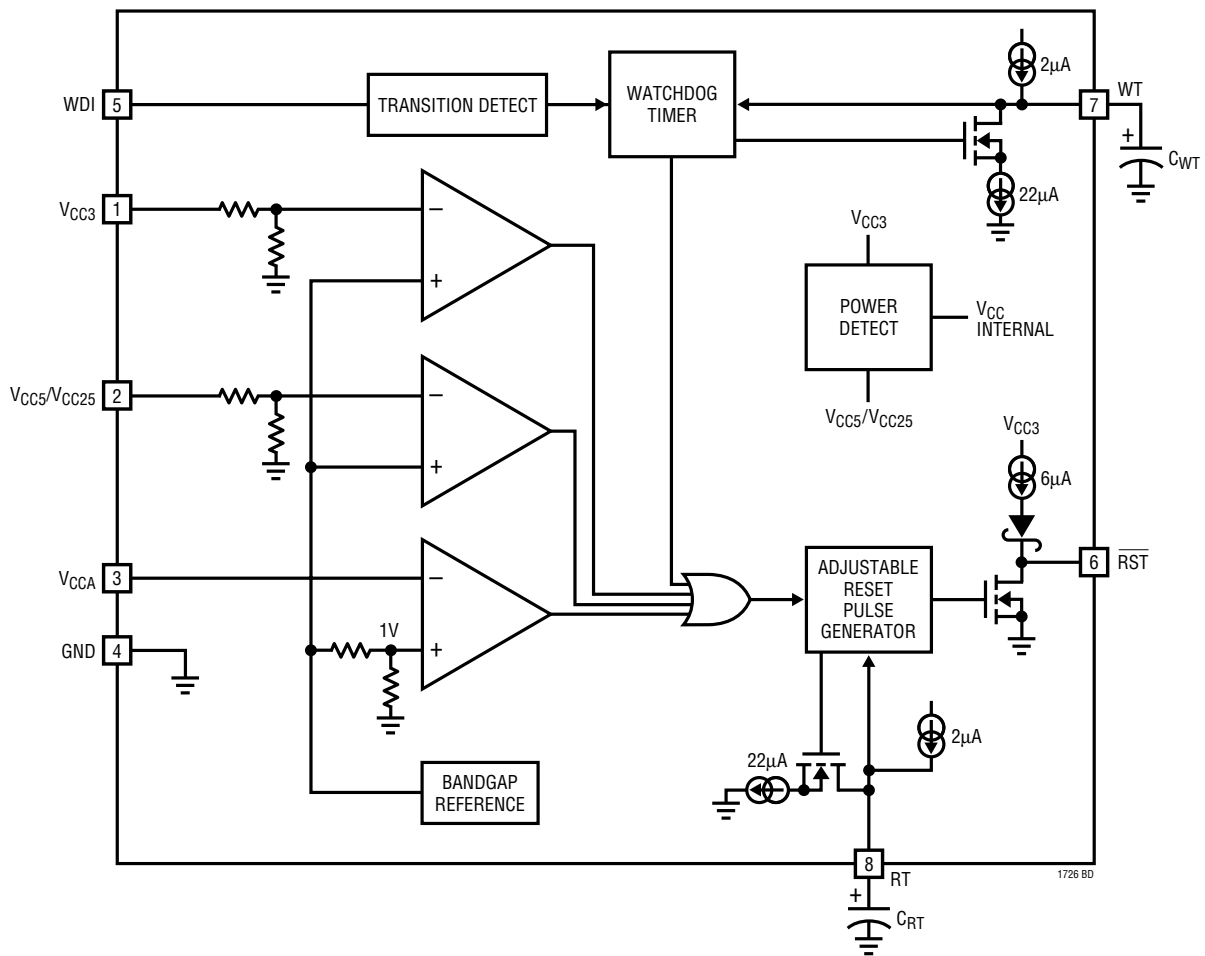

TIMING DIAGRAMS

V_{CC} Monitor Timing

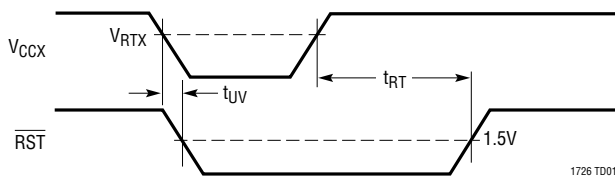

Watchdog Timing Diagram

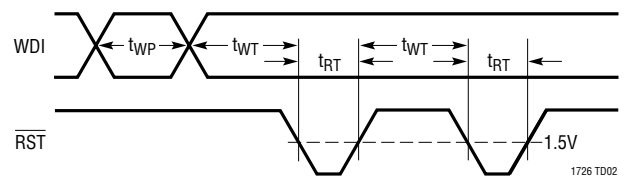

APPLICATIONS INFORMATION

Supply Monitoring

The LTC1726 is a low power, high accuracy triple supply monitor and watchdog timer. The watchdog and reset periods are both adjustable using external capacitors.

All three V_{CC} inputs must be above predetermined thresholds for reset not to be asserted. The LTC1726 will assert reset during power-up, power-down and brownout conditions on any one or all of the V_{CC} inputs.

Upon power-up, either the V_{CC5}/V_{CC25} or V_{CC3} pin can power the drive circuits for the \overline{RST} pin. This ensures that \overline{RST} will be low when either V_{CC5}/V_{CC25} or V_{CC3} reaches 1V. As long as any one of the V_{CC} inputs is below its predetermined threshold, \overline{RST} will stay a logic low. Once all of the V_{CC} inputs rise above their thresholds, the adjustable reset timer is started and \overline{RST} is released after the reset time-out period.

On power-down, once any of the V_{CC} inputs drops below its threshold, \overline{RST} is held at a logic low. A logic low of 0.3V is guaranteed until both V_{CC3} and V_{CC5}/V_{CC25} drop below 1V.

3V or 5V/2.5V Power Detect

Since the LTC1726 is a multisupply monitor, it will be required to assert reset as soon as there is power on any one of the monitor inputs. Therefore, the part derives its power from either the V_{CC3} or V_{CC5}/V_{CC25} input, whichever pin has the greatest potential. This ensures the part pulls the \overline{RST} pin low as soon as either input pin is $\geq 1V$. The adjustable input is excluded from being a potential supply pin because of its 1V nominal operating range.

Override Functions (5V Versions Only)

The V_{CCA} pin, if unused, can be tied to either V_{CC3} or V_{CC5} . This is an obvious solution since the trip points for V_{CC3} and V_{CC5} will always be greater than the trip point for V_{CCA} .

The V_{CC5} input trip point is disabled if its voltage is equal to the voltage on $V_{CC3} \pm 25mV$ and the voltage on V_{CC5} is less than 4.15V. In this manner the LTC1726-5 behaves as a 3.3V monitor and the 5V reset function is disabled.

The V_{CC5} trip point is re-enabled when the voltage on V_{CC5} is equal to the voltage on $V_{CC3} \pm 25mV$ and the two inputs are greater than approximately 4.15V. In this

manner, the part can function as a 5V monitor with the 3.3V monitor disabled.

When monitoring either 3.3V or 5V with V_{CC3} strapped to V_{CC5} , (see Figure 1) the part determines which is the appropriate range. The part handles this situation as shown in Figure 2. Above 1V and below V_{RT3} , \overline{RST} is held low. From V_{RT3} to approximately 4.15V, the part assumes 3.3V supply monitoring and \overline{RST} is deasserted. Above approximately 4.15V, the part operates as a 5V monitor. In most systems, the 5V supply will pass through the 3.1V to 4.15V region in $<200ms$ during power-up, and the \overline{RST} output will behave as desired. Table 1 summarizes the state of \overline{RST} at various operating voltages with $V_{CC3} = V_{CC5}$.

Table 1. Override Truth Table ($V_{CC3} = V_{CC5}$)

INPUTS ($V_{CC3} = V_{CC5} = V_{CC}$)	\overline{RST}
$0V \leq V_{CC} \leq 1V$	—
$1V \leq V_{CC} \leq V_{RT3}$	0
$V_{RT3} \leq V_{CC} \leq 4.15V$	1
$4.15V \leq V_{CC} \leq V_{RT5}$	0
$V_{RT5} \leq V_{CC}$	1

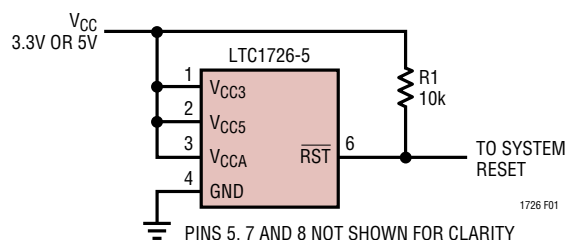

Figure 1. Single Supply Monitor with Others Disabled

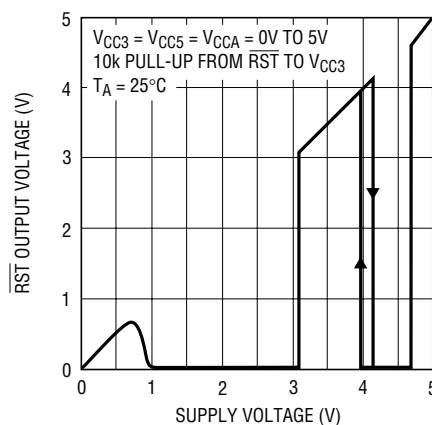

Figure 2. \overline{RST} Voltage vs Supply Voltage

APPLICATIONS INFORMATION

Figure 3 contains a simple circuit for 5V systems that can't risk the $\overline{\text{RST}}$ output going high in the 3.1V to 4.15V range (possibly due to very slow rise time on the 5V supply). Diode D1 powers the LTC1726-5 while dropping $\approx 0.6\text{V}$ from the V_{CC5} pin to the V_{CC3} pin. This prevents the part's internal override circuit from being activated. Without the override circuit active, the $\overline{\text{RST}}$ pin stays low until V_{CC5} reaches $V_{\text{RT5}} \cong 4.675\text{V}$. (See Figure 4.)

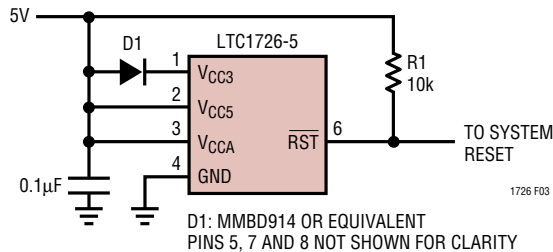

Figure 3. LTC1726-5 Monitoring a Single 5V Supply. D1 Used to Avoid $\overline{\text{RST}}$ High Near 3.1V to 4V (See Figure 2).

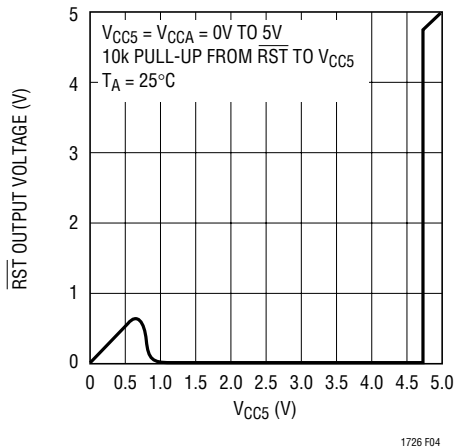

Figure 4. $\overline{\text{RST}}$ Output Voltage Characteristics of the Circuit in Figure 3

LTC1726-2.5 Override Functions

The V_{CCA} pin, if unused, can be tied to either V_{CC3} or V_{CC25} . This is an obvious solution since the trip points for V_{CC3} and V_{CC25} will always be greater than the trip point for V_{CCA} . Likewise, the V_{CC25} , if unused, can be tied to V_{CC3} . V_{CC3} must always be used. Tying V_{CC3} to V_{CC25} and operating off of a 2.5V supply will result in the continuous assertion of $\overline{\text{RST}}$.

Watchdog Timer

The watchdog circuit monitors a μP 's activity. The μP is required to change the logic state of the WDI pin on a periodic basis in order to clear the watchdog timer and prevent the LTC1726 from issuing a reset.

During power-up, the watchdog timer remains cleared while reset is asserted. As soon as the reset timer times out, the watchdog timer is started. The watchdog timer will continue to run until a transition is detected on the WDI input or until the watchdog timer times out. Once the watchdog timer times out, the internal circuitry asserts the reset and starts the reset timer. When the reset timer times out and reset is deasserted, the watchdog timer is again started. If no WDI transition is received within the watchdog time-out period, the reset will be reasserted at the end of the watchdog time-out period. If a transition is received on the WDI input during the watchdog time-out period, the watchdog timer will be restarted and reset will remain deasserted.

The WDI pin should be toggled at a frequency no faster than the maximum frequency given below:

$$F_{\text{WD}}(\text{Hz}) = \frac{1}{(315,000\text{V/A}) \cdot (C_{\text{WT}}) + 4\mu\text{s}}$$

with C_{WT} in Farads.

The maximum operating frequency, independent of duty cycle, is 250kHz with no capacitor on the C_{WT} pin.

APPLICATIONS INFORMATION

Selecting the Reset and Watchdog Time-Out Capacitors

The reset time-out period is adjustable in order to accommodate a variety of μP applications. The reset time-out period, t_{RT} , is adjusted by connecting a capacitor, C_{RT} , between the RT pin and ground. The value of this capacitor is determined as follows:

$$C_{\text{RT}} = t_{\text{RT}}/3.30$$

with C_{RT} in pF and t_{RT} in μs (i.e., $1500\text{pF} \Rightarrow 4.95\text{ms}$). The capacitor should be a low leakage type. A ceramic capacitor is recommended.

The watchdog period is also adjustable so that the watchdog time-out period can be optimized for software execution. The watchdog time-out period, t_{WT} , is adjusted by connecting a capacitor, C_{WT} , between the WT pin and ground. Once the optimum watchdog time-out period (t_{WT}) is determined, the value of the capacitor is calculated as follows:

$$C_{\text{WT}} = t_{\text{WT}}/21.8$$

with C_{WT} in pF and t_{WT} in μs (i.e., $1500\text{pF} \Rightarrow 32.7\text{ms}$). The capacitor should be a low leakage type. A ceramic capacitor is recommended.

TYPICAL APPLICATIONS

Disabling the Watchdog Timer

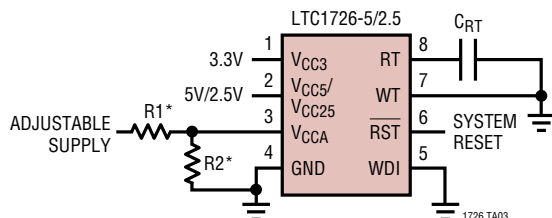

*TO PRESERVE THRESHOLD ACCURACY, SET PARALLEL COMBINATION OF R1 AND R2 $\leq 66.5\text{k}$

THE WATCHDOG TIMER CAN BE DISABLED BY CONNECTING THE WDI AND WT PINS TO GROUND. THE PART WILL ACT STRICTLY AS A TRIPLE SUPPLY MONITOR WITH AN ADJUSTABLE RESET TIME-OUT PERIOD

Triple Supply Monitor (3.3V, 5V and Adjustable)

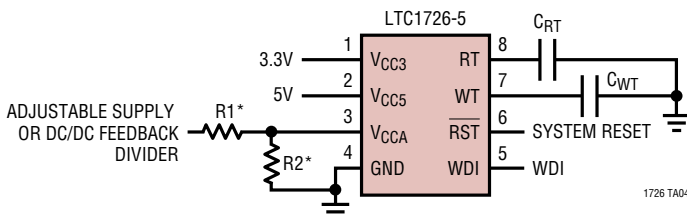

*TO PRESERVE THRESHOLD ACCURACY, SET PARALLEL COMBINATION OF R1 AND R2 $\leq 66.5\text{k}$

Dual Supply Monitor (3.3V and 5V, Defeat VCCA Input)

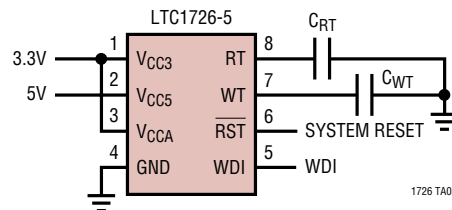

TYPICAL APPLICATIONS

Dual Supply Monitor (3.3V or 5V Plus Adjustable)

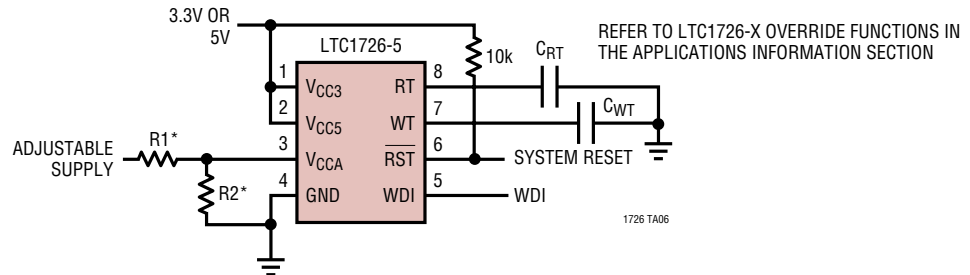

*TO PRESERVE THRESHOLD ACCURACY, SET PARALLEL COMBINATION OF R1 AND R2 \leq 66.5k

Dual Supply Monitor (3.3V Plus Adjustable)

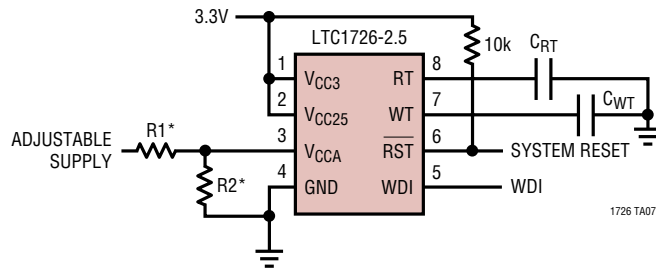

*TO PRESERVE THRESHOLD ACCURACY, SET PARALLEL COMBINATION OF R1 AND R2 \leq 66.5k

Using V_{CC}A Tied to DC/DC Feedback Divider

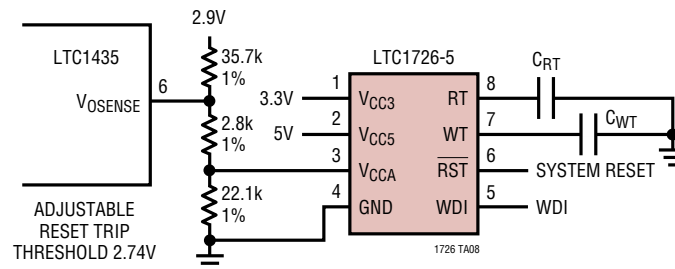

PACKAGE DESCRIPTION Dimensions in (inches) unless otherwise noted.

MS8 Package
8-Lead Plastic MSOP
 (Reference LTC DWG # 05-08-1660)

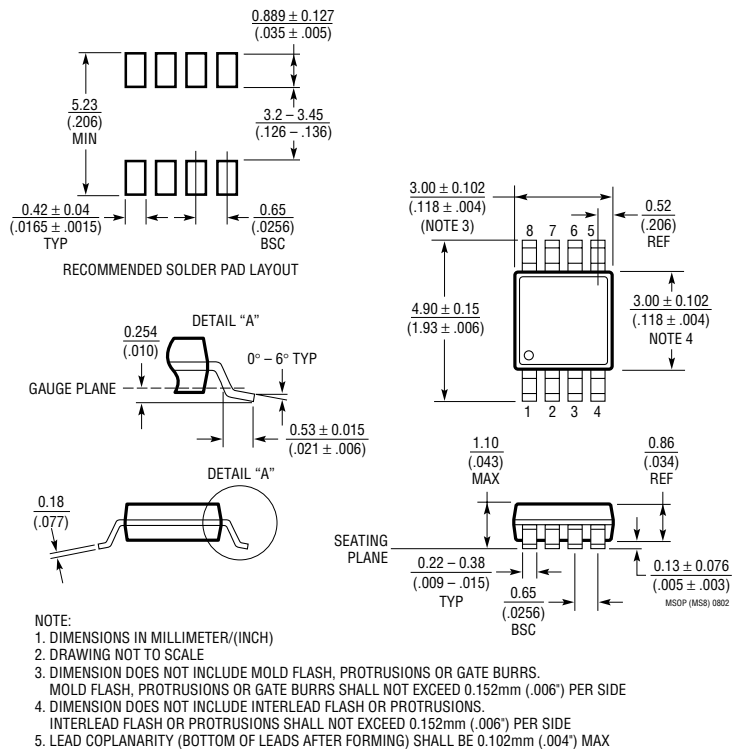

S8 Package
8-Lead Plastic Small Outline (Narrow .150 Inch)
 (Reference LTC DWG # 05-08-1610)

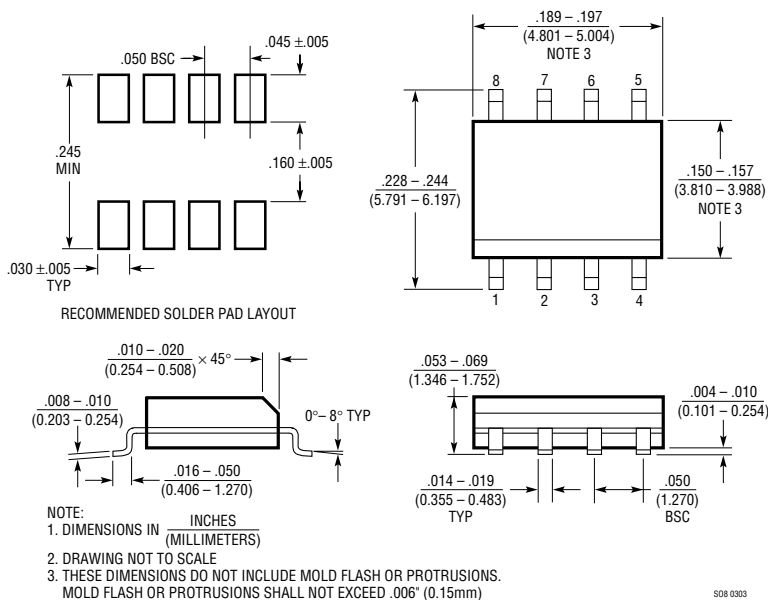

TYPICAL APPLICATION

Triple Supply Monitor with Watchdog Timer and Manual Reset Button

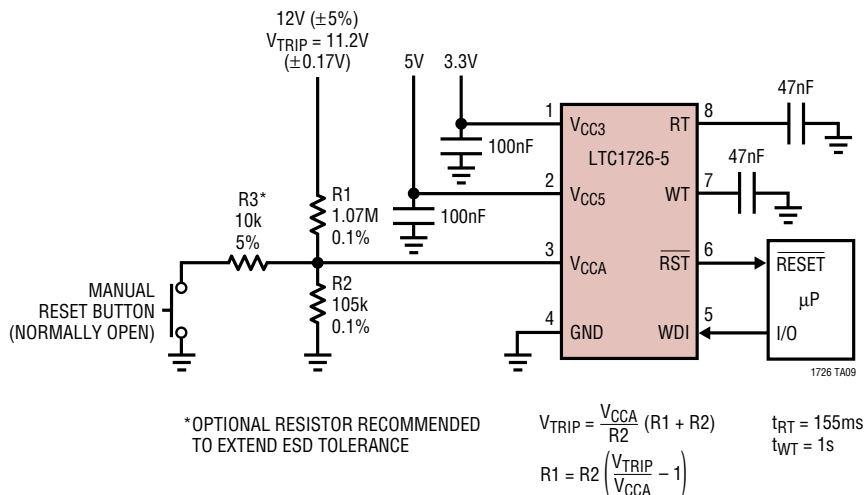

RELATED PARTS

PART NUMBER	DESCRIPTION	COMMENTS
LTC690	5V Supply Monitor, Watchdog Timer and Battery Backup	4.65V Threshold
LTC694-3.3	3.3V Supply Monitor, Watchdog Timer and Battery Backup	2.9V Threshold
LTC699	5V Supply Monitor and Watchdog Timer	4.65V Threshold
LTC1232	5V Supply Monitor, Watchdog Timer and Push-Button Reset	4.37V/4.62V Threshold
LTC1326	Micropower Precision Triple Supply Monitor for 5V, 3.3V and ADJ	4.725V, 3.118V, 1V Thresholds (±0.75%) 5V, 3.3V, ADJ
LTC1326-2.5	Micropower Precision Triple Supply Monitor for 2.5V, 3.3V and ADJ	2.363V, 3.118V, 1V Thresholds (±0.75%) 2.5V, 3.3V, ADJ
LTC1536	Precision Triple Supply Monitor for PCI Applications	Meets PCI t_{FAIL} Timing Specifications
LTC1727-5	Micropower Triple Supply Monitor with Individual Outputs	4.675V, 3.086V, 1V Thresholds (±1.5%) 5V, 3.3V, ADJ
LTC1727-2.5	Micropower Triple Supply Monitor with Individual Outputs	2.338V, 3.086V, 1V Thresholds (±1.5%) 2.5V, 3.3V, ADJ
LTC1728-5	Micropower Triple Supply Monitor in 5-Pin SOT-23 Package	4.675V, 3.086V, 1V Thresholds (±1.5%) 5V, 3.3V, ADJ
LTC1728-2.5	Micropower Triple Supply Monitor in 5-Pin SOT-23 Package	2.338V, 3.086V, 1V Thresholds (±1.5%) 2.5V, 3.3V, ADJ
LTC1728-1.8	Micropower Triple Supply Monitor in 5-Pin SOT-23 Package	2.805V, 1.683V, 1V Thresholds (±1.5%) 3V, 1.8V, ADJ
LTC1985-1.8	Micropower Triple Supply Monitor for 3V, 1.8V and ADJ	Push-Pull \overline{RESET} Output, SOT-23
LTC2900	Quad Supply Monitor	Adjustable Reset Timer
LTC2901	Quad Supply Monitor with Watchdog Timer	Adjustable Watchdog and Reset Timers
LTC2902	Quad Supply Monitor with Selectable Supply Tolerance	Reset Disable for Margining Applications