

THIS DOCUMENT CONTAINS DATA PROPRIETARY TO PROJECTS UNLIMITED, INC. ANY USE OR REPRODUCTION, IN ANY FORM, WITHOUT PRIOR WRITTEN PERMISSION OF PROJECTS UNLIMITED, INC. IS PROHIBITED.

SPECIFICATIONS

PARAMETERS	VALUES	UNITS
DIRECTIVITY	OMNI	-
SENSITIVITY	-38±3	dB
STANDARD OPERATING VOLTAGE	2	Vdc
MAX OPERATING VOLTAGE	10	Vdc
CURRENT CONSUMPTION (MAX)	0.5	mA
IMPEDANCE	2,200	K Ohm
SIGNAL TO NOISE RATIO	60	dB
TERMINAL	SOLDER PADS	-

REVISIONS			
LTR	DESCRIPTION	DATE	APPROVED
-	RELEASED FROM ENGINEERING	11/13/03	

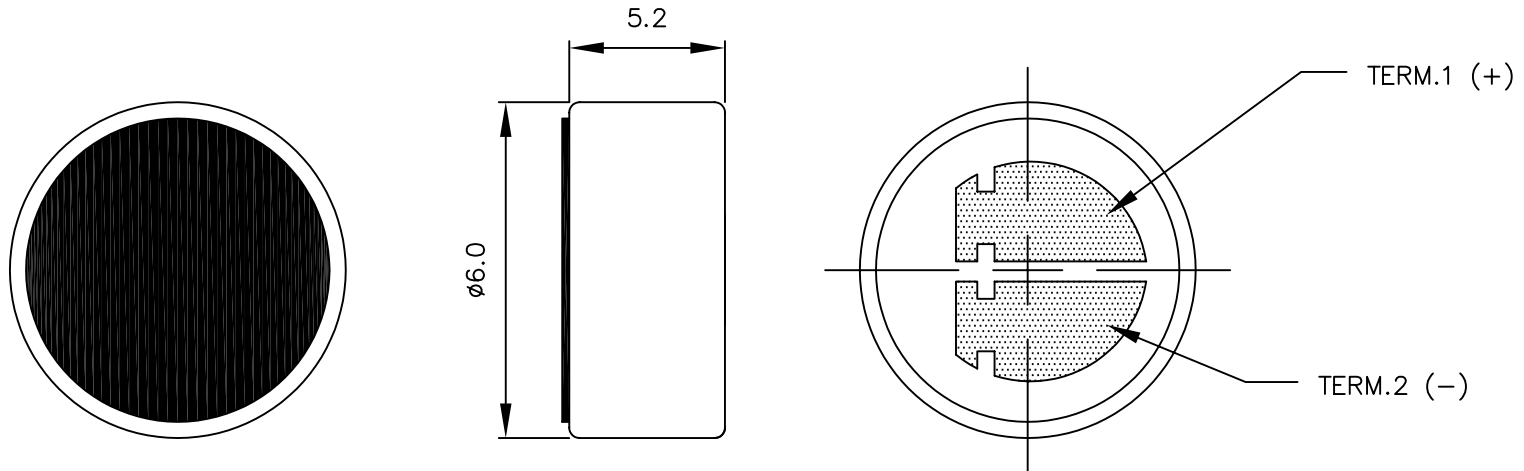

NOTES:

1. ALL DIMENSIONS ARE IN MILLIMETERS.
2. SPECIFICATION SUBJECT TO CHANGE OR WITHDRAWAL WITHOUT NOTICE.

FILE NAME
POM-5238L.DWG

UNLESS OTHERWISE SPECIFIED:
DIMENSIONS ARE IN MILLIMETERS,
TOLERANCES ARE ±0.5 AND ANGLES ARE
±3°.



projects®
unlimited

Dayton, Ohio

APPROVALS	DATE
DRAWN <i>R.A.C.</i>	11/03
APPROVED <i>R.W.</i>	11/03

SIZE
A

MICROPHONE
POM-5238L

DRAWING NO.
POM-5238L

DO NOT SCALE DRAWING

SCALE: N.T.S.

SHEET 1 OF 1