

Absolute Maximum Ratings		Values ... 123 D	Units
Symbol	Conditions ¹⁾		
V _{CES}		1200	V
V _{CGR}	R _{GE} = 20 kΩ	1200	V
I _C	T _{case} = 25/80 °C	50 / 40	A
I _{CM}	T _{case} = 25/80 °C; t _p = 1 ms	100 / 80	A
V _{GES}		± 20	V
P _{tot}	per IGBT, T _{case} = 25 °C	310	W
T _j , (T _{stg})		- 40 ... +150 (125)	°C
V _{isol}	AC, 1 min.	2 500	V
humidity	DIN 40 040	Class F	
climate	DIN IEC 68 T.1	40/125/56	
Diodes			
I _F = - I _C	T _{case} = 25/80 °C	50 / 40	A
I _{FM} = - I _{CM}	T _{case} = 25/80 °C; t _p = 1 ms	100 / 80	A
I _{FSM}	t _p = 10 ms; sin.; T _j = 150 °C	550	
I ² t	t _p = 10 ms; T _j = 150 °C	1500	A ² s

Characteristics					
Symbol	Conditions ¹⁾	min.	typ.	max.	Units
V _{(BR)CES}	V _{GE} = 0, I _C = 1 mA	≥ V _{CES}	-	-	V
V _{GE(th)}	V _{GE} = V _{CE} , I _C = 2 mA	4,5	5,5	6,5	V
I _{CES}	V _{GE} = 0 } T _j = 25 °C	-	0,3	1	mA
		V _{CE} = V _{CES} } T _j = 125 °C	-	3	-
I _{GES}	V _{GE} = 20 V, V _{CE} = 0		-	-	200
V _{CEsat}	I _C = 40 A } V _{GE} = 15 V; } T _j = 25 (125) °C	-	2,5(3,1)	3(3,7)	V
V _{CEsat}		I _C = 50 A } T _j = 25 (125) °C	-	2,7(3,5)	-
g _{fs}	V _{CE} = 20 V, I _C = 40 A	-	30	-	S
C _{CHC}	per IGBT	-	-	350	pF
C _{ies}	} V _{GE} = 0 } } V _{CE} = 25 V } } f = 1 MHz }	-	3300	4000	pF
C _{oes}		-	500	600	pF
C _{res}		-	220	300	pF
L _{CE}		-	-	30	nH
t _{d(on)}	} V _{CC} = 600 V } } V _{GE} = + 15 V / - 15 V ³⁾ } } I _C = 40 A, ind. load } } R _{Gon} = R _{Goff} = 27 Ω } } T _j = 125 °C }	-	70	-	ns
t _r		-	60	-	ns
t _{d(off)}		-	400	-	ns
t _f		-	45	-	ns
E _{on} ⁵⁾		-	7	-	mWs
E _{off} ⁵⁾		-	4,5	-	mWs
Diodes ⁸⁾					
V _F = V _{EC}	I _F = 40 A } V _{GE} = 0 V; } I _F = 50 A } T _j = 25 (125) °C }	-	1,85(1,6)	2,2	V
V _F = V _{EC}		-	2,0(1,8)	-	V
V _{TO}	T _j = 125 °C	-	-	1,2	V
r _T	T _j = 125 °C	-	-	22	mΩ
I _{RRM}	I _F = 40 A; T _j = 25 (125) °C ²⁾	-	23(35)	-	A
Q _{rr}	I _F = 40 A; T _j = 25 (125) °C ²⁾	-	2,3(7)	-	μC
Thermal Characteristics					
R _{thjc}	per IGBT	-	-	0,4	°C/W
R _{thjc}	per diode	-	-	0,7	°C/W
R _{thch}	per module	-	-	0,05	°C/W

SEMITRANS® M IGBT Modules

SKM 50 GB 123 D
SKM 50 GAL 123 D



SEMITRANS 2

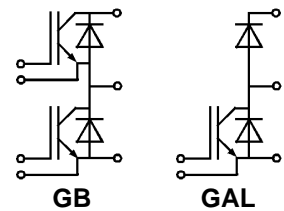

Features

- MOS input (voltage controlled)
- N channel, Homogeneous Si
- Low inductance case
- Very low tail current with low temperature dependence
- High short circuit capability, self limiting to 6 * I_{cnom}
- Latch-up free
- Fast & soft inverse CAL diodes⁸⁾
- Isolated copper baseplate using DCB Direct Copper Bonding Technology
- Large clearance (10 mm) and creepage distances (20 mm).

Typical Applications: → B 6 - 85

- Three phase inverter drives
- Switching (not for linear use)

¹⁾ T_{case} = 25 °C, unless otherwise specified

²⁾ I_F = - I_C, V_R = 600 V, - di_F/dt = 800 A/μs, V_{GE} = 0 V

³⁾ Use V_{GEoff} = -5 ... -15 V

⁵⁾ See fig. 2 + 3; R_{Goff} = 27 Ω

⁸⁾ CAL = Controlled Axial Lifetime Technology.

Case and mech. data → B 6 - 86
SEMITRANS 2

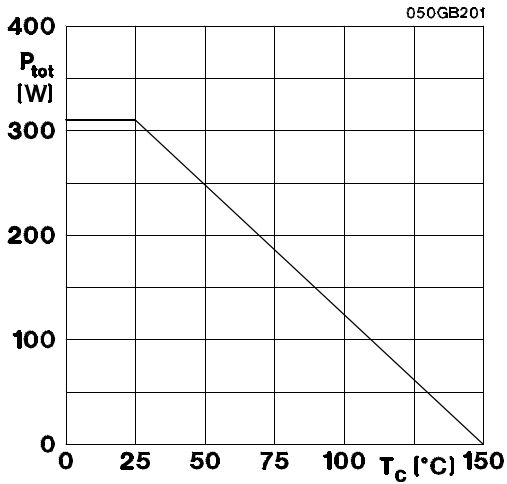

Fig. 1 Rated power dissipation $P_{tot} = f(T_c)$

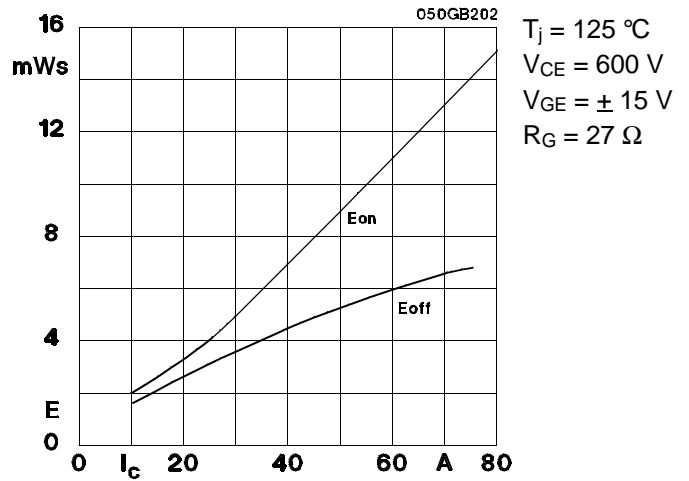

Fig. 2 Turn-on /-off energy $= f(I_c)$

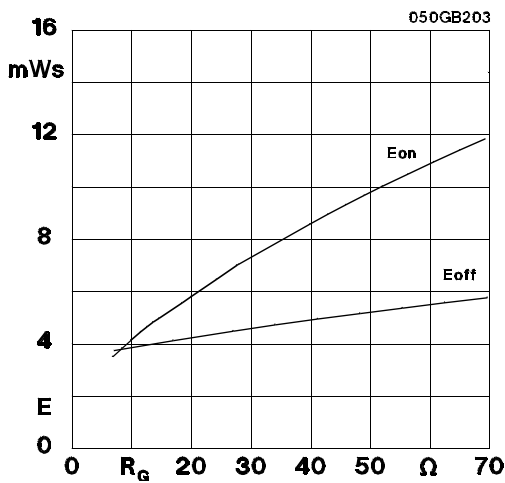

Fig. 3 Turn-on /-off energy $= f(R_g)$

$T_j = 125\text{ °C}$
 $V_{CE} = 600\text{ V}$
 $V_{GE} = \pm 15\text{ V}$
 $I_c = 40\text{ A}$

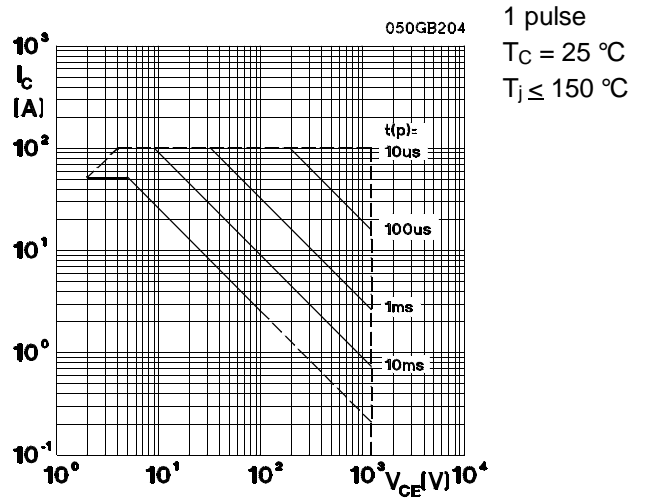

Fig. 4 Maximum safe operating area (SOA) $I_c = f(V_{CE})$

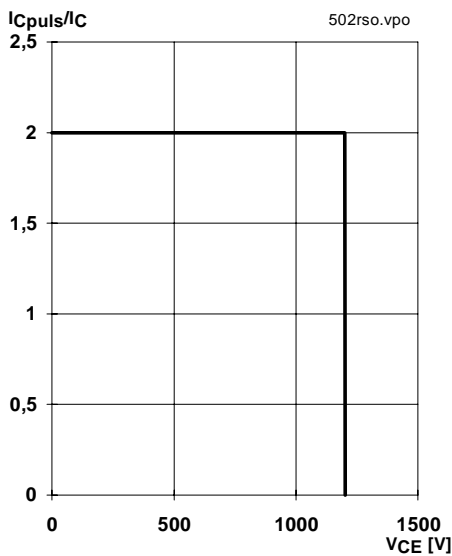

Fig. 5 Turn-off safe operating area (RBSOA)

$T_j \leq 150\text{ °C}$
 $V_{GE} = \pm 15\text{ V}$
 $R_{Goff} = 27\text{ }\Omega$
 $I_c = 40\text{ A}$

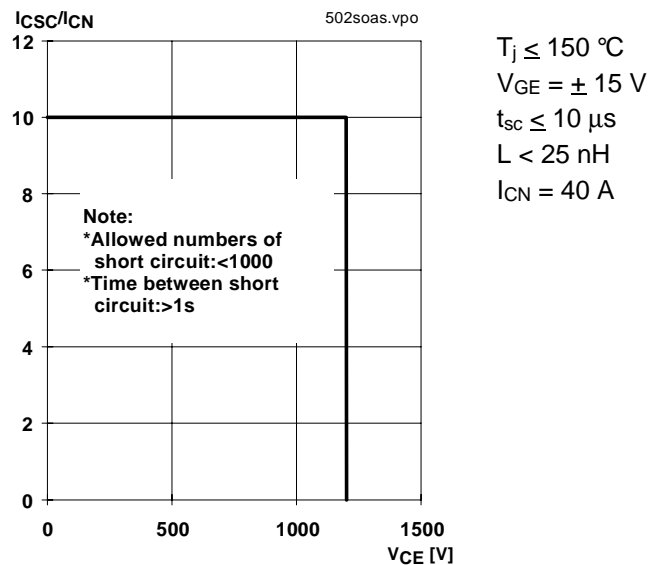

Fig. 6 Safe operating area at short circuit $I_c = f(V_{CE})$

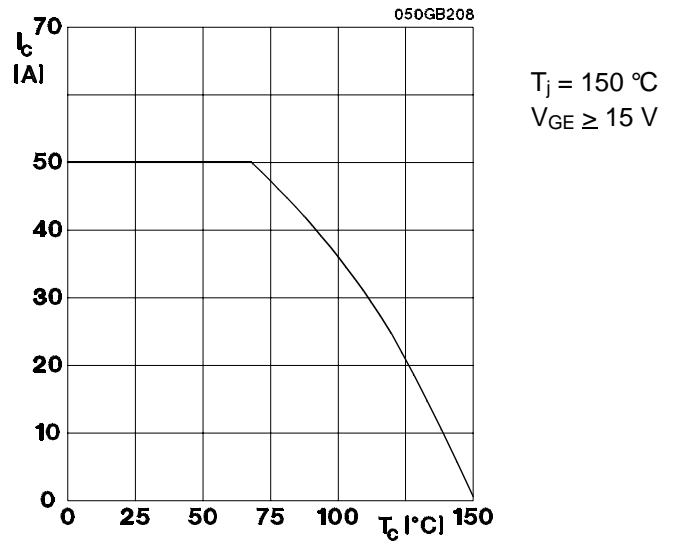

Fig. 8 Rated current vs. temperature $I_C = f(T_C)$

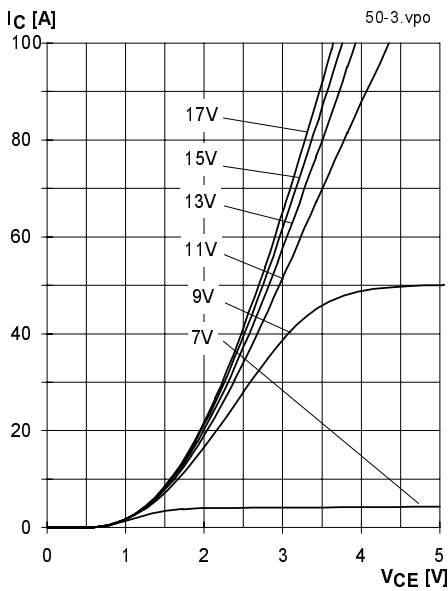

Fig. 9 Typ. output characteristic, $t_p = 80 \mu s$; $25 \text{ }^\circ\text{C}$

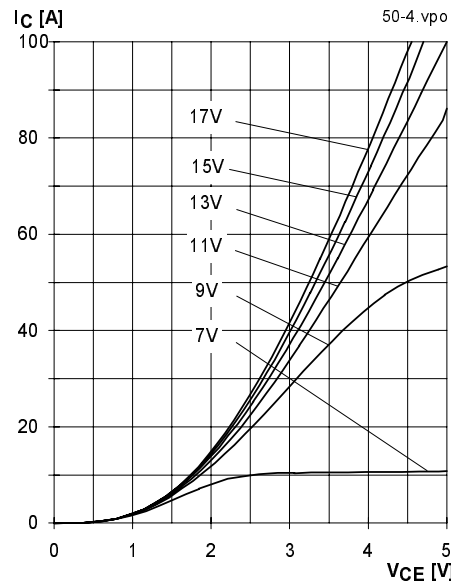

Fig. 10 Typ. output characteristic, $t_p = 80 \mu s$; $125 \text{ }^\circ\text{C}$

$$P_{\text{cond}}(t) = V_{\text{CEsat}}(t) \cdot I_C(t)$$

$$V_{\text{CEsat}}(t) = V_{\text{CE(TO)(Tj)}} + r_{\text{CE(Tj)}} \cdot I_C(t)$$

$$V_{\text{CE(TO)(Tj)}} \leq 1,5 + 0,002 (T_j - 25) \text{ [V]}$$

$$\text{typ.: } r_{\text{CE(Tj)}} = 0,02 + 0,00008 (T_j - 25) \text{ } [\Omega]$$

$$\text{max.: } r_{\text{CE(Tj)}} = 0,03 + 0,00010 (T_j - 25) \text{ } [\Omega]$$

$$\text{valid for } V_{\text{GE}} = +15 \begin{matrix} +2 \\ -1 \end{matrix} \text{ [V]; } I_C > 0,3 I_{\text{Cnom}}$$

Fig. 11 Saturation characteristic (IGBT)
Calculation elements and equations

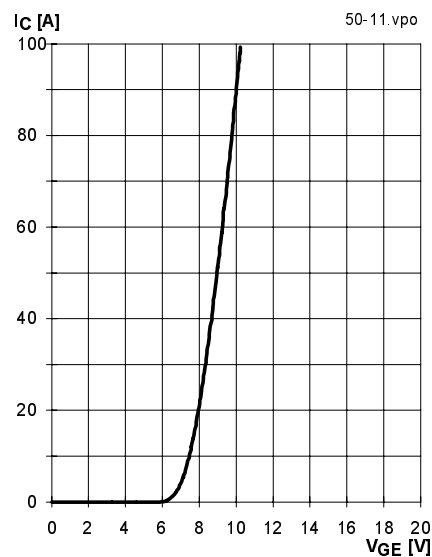

Fig. 12 Typ. transfer characteristic, $t_p = 80 \mu s$; $V_{\text{CE}} = 20 \text{ V}$

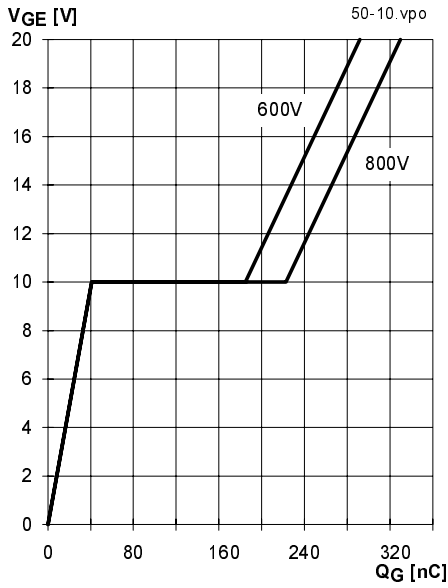

Fig. 13 Typ. gate charge characteristic

$I_{Cpuls} = 50 \text{ A}$

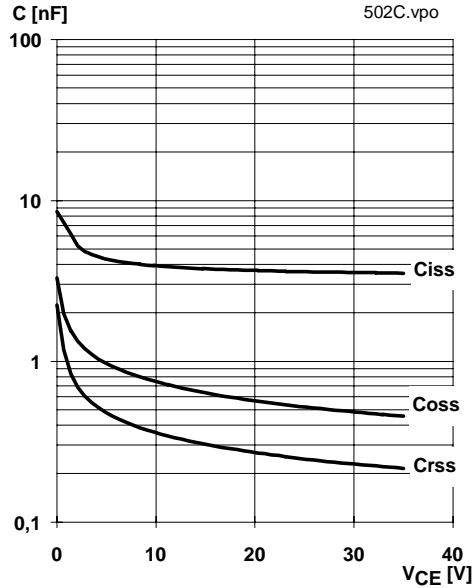

Fig. 14 Typ. capacitances vs. V_{CE}

$V_{GE} = 0 \text{ V}$
 $f = 1 \text{ MHz}$

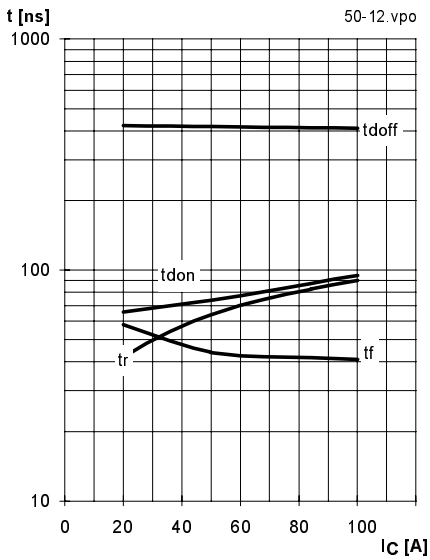

Fig. 15 Typ. switching times vs. I_C

$T_j = 125 \text{ }^\circ\text{C}$
 $V_{CE} = 600 \text{ V}$
 $V_{GE} = \pm 15 \text{ V}$
 $R_{Gon} = 27 \text{ } \Omega$
 $R_{Goff} = 27 \text{ } \Omega$
induct. load

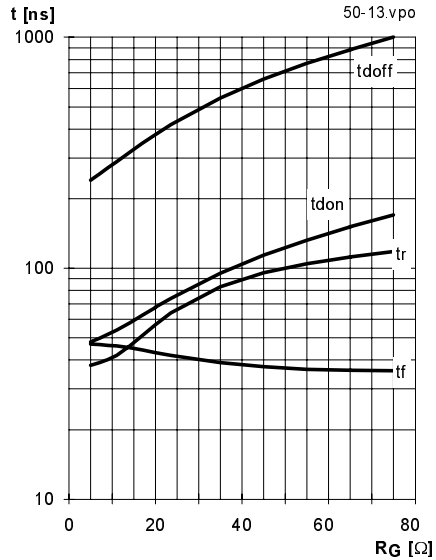

Fig. 16 Typ. switching times vs. gate resistor R_G

$T_j = 125 \text{ }^\circ\text{C}$
 $V_{CE} = 600 \text{ V}$
 $V_{GE} = \pm 15 \text{ V}$
 $I_C = 40 \text{ A}$
induct. load

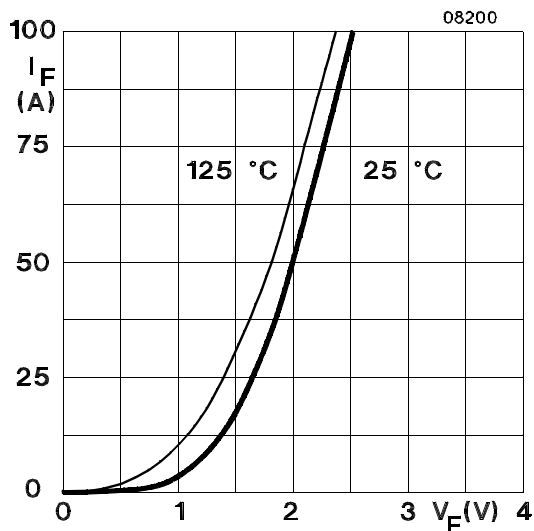

Fig. 17 Typ. CAL diode forward characteristic

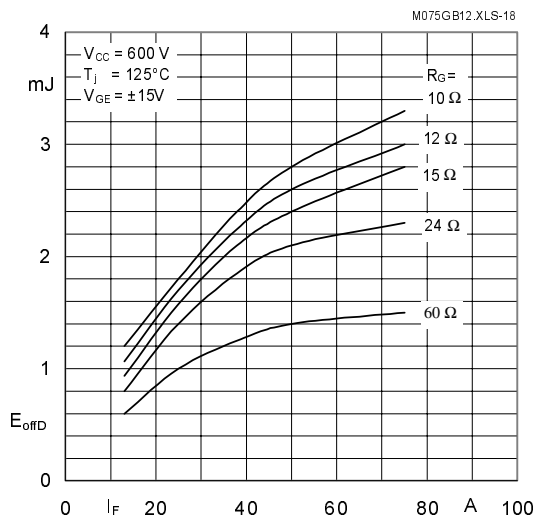

Fig. 18 Diode turn-off energy dissipation per pulse

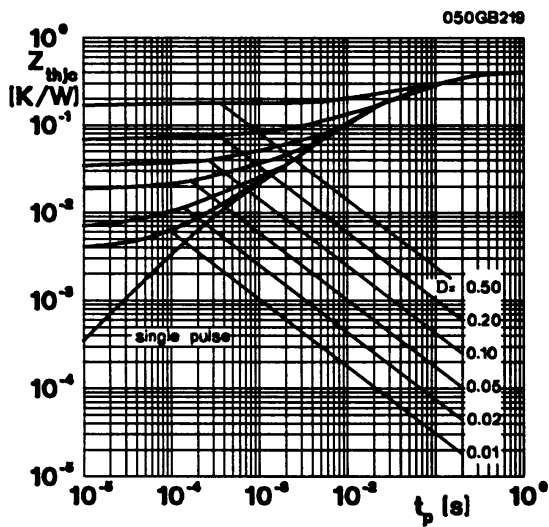

Fig. 19 Transient thermal impedance of IGBT
 $Z_{thJC} = f(t_p)$; $D = t_p / t_c = t_p \cdot f$

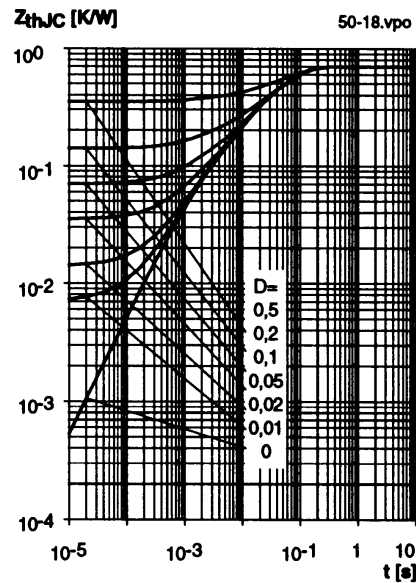

Fig. 20 Transient thermal impedance of inverse CAL diodes
 $Z_{thJC} = f(t_p)$; $D = t_p / t_c = t_p \cdot f$

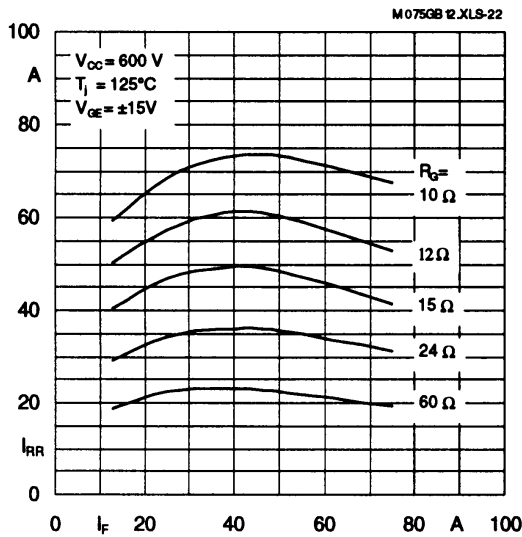

Fig. 22 Typ. CAL diode peak reverse recovery current
 $I_{RR} = f(I_F, R_G)$

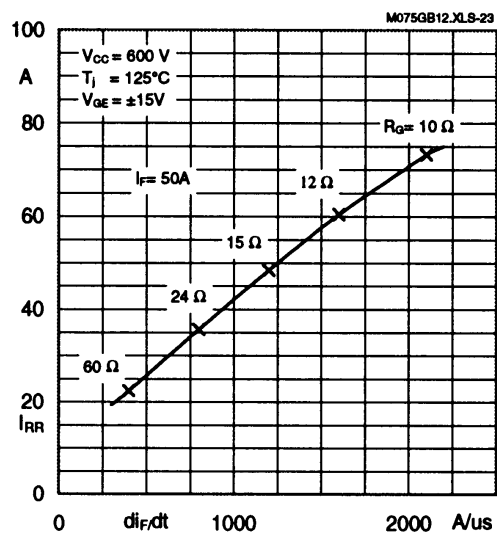

Fig. 23 Typ CAL diode peak reverse recovery current
 $I_{RR} = f(di/dt)$

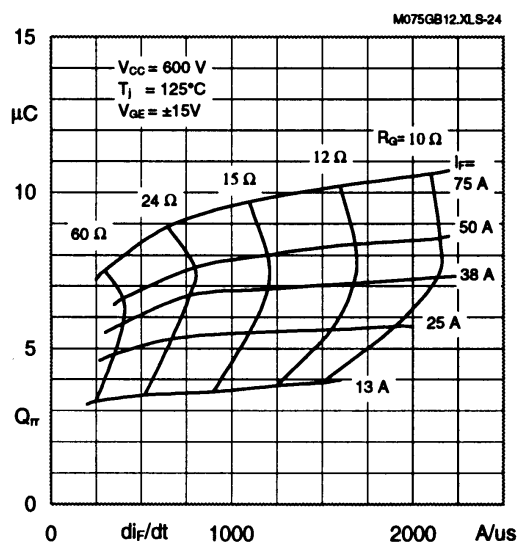

Fig. 24 Typ. CAL diode recovery charge

Typical Applications

include

- Switched mode power supplies
- DC servo and robot drives
- Inverters
- DC choppers
- AC motor speed control
- Inductive heating
- UPS Uninterruptable power supplies
- General power switching applications
- Electronic (also portable) welders
- Pulse frequencies also above 15 kHz

SEMISTRANS 2

Case D 61

UL Recognized

File no. E 63 532

SKM 50 GB 123 D

CASED61

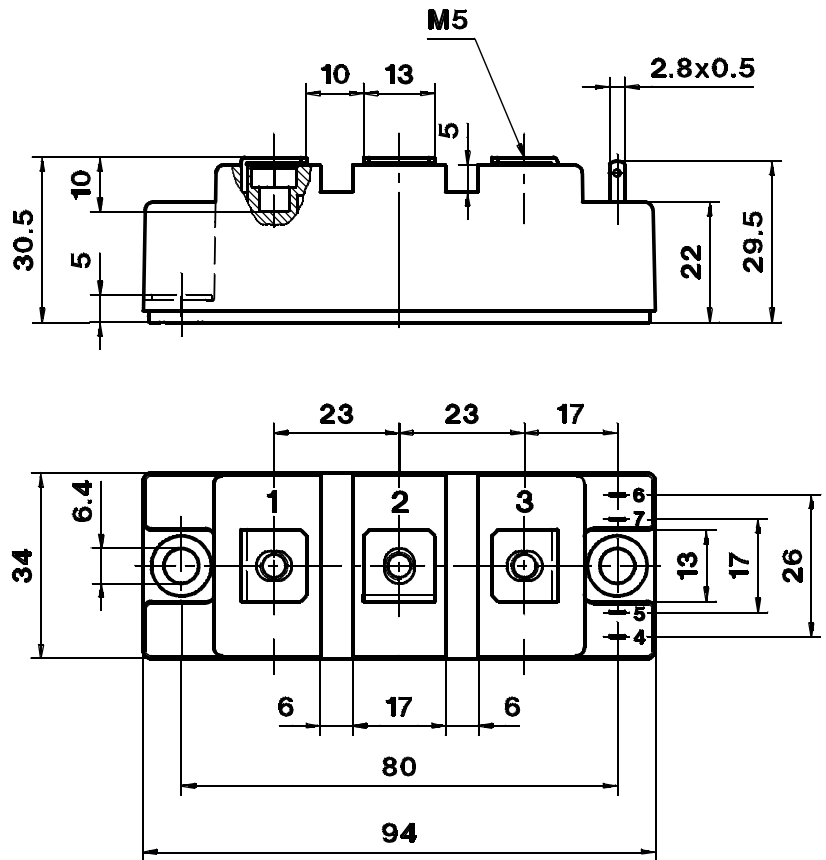
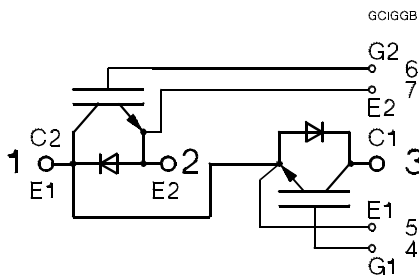

Dimensions in mm

SKM 50 GAL 123 D

Case D 62 (→ D 61)

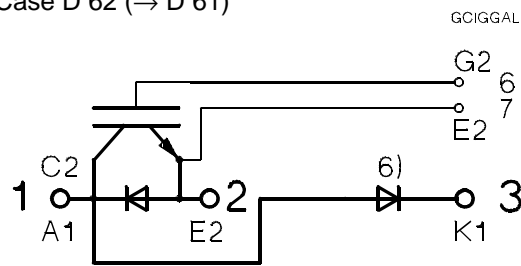

Case outline and circuit diagrams

Mechanical Data		Values			Units
Symbol	Conditions	min.	typ.	max.	
M ₁	to heatsink, SI Units (M6)	3	—	5	Nm
	to heatsink, US Units	27	—	44	lb.in.
M ₂	for terminals, SI Units (M5)	2,5	—	5	Nm
	for terminals US Units	22	—	44	lb.in.
a		—	—	5x9,81	m/s ²
w		—	—	160	g

This is an electrostatic discharge sensitive device (ESDS). Please observe the international standard IEC 747-1, Chapter IX.

Eight devices are supplied in one SEMIBOX A without mounting hardware, which can be ordered separately under Ident No. 33321100 (for 10 SEMISTRANS 2)
Larger packaging units of 20 or 42 pieces are used if suitable
Accessories → B 6-4.
SEMIBOX → C-1.