

Agilent 4N25 Phototransistor Optocoupler General Purpose Type Data Sheet

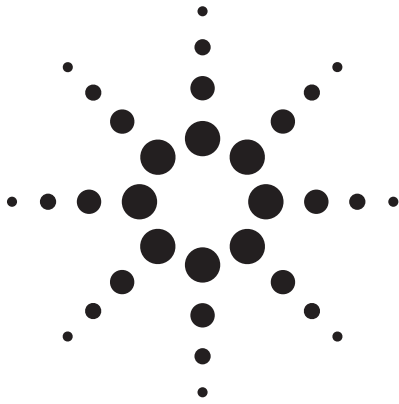

Description

The 4N25 is an optocoupler for general purpose applications. It contains a light emitting diode optically coupled to a phototransistor. It is packaged in a 6-pin DIP package and available in wide-lead spacing option and lead bend SMD option. Response time, t_r , is typically 3 μ s and minimum CTR is 20% at input current of 10 mA.

Ordering Information

Specify part number followed by Option Number (if desired).

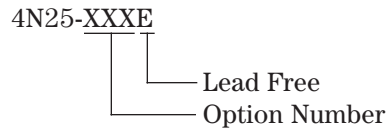

- 000 = No Options
- 060 = IEC/EN/DIN EN 60747-5-2 Option
- W00 = 0.4" Lead Spacing Option
- 300 = Lead Bend SMD Option
- 500 = Tape and Reel Packaging Option

Features

- Response time (t_r : typ., 3 μ s at $V_{CE} = 10$ V, $I_C = 2$ mA, $R_L = 100$ Ω)
- Current Transfer Ratio (CTR: min. 20% at $I_F = 10$ mA, $V_{CE} = 10$ V)
- Input-output isolation voltage ($V_{iso} = 2500$ Vrms)
- Dual-in-line package
- UL approved
- CSA approved
- IEC/EN/DIN EN 60747-5-2 approved
- Options available:
 - Leads with 0.4" (10.16 mm) spacing (W00)
 - Leads bends for surface mounting (300)
 - Tape and reel for SMD (500)
 - IEC/EN/DIN EN 60747-5-2 approvals (060)

Functional Diagram

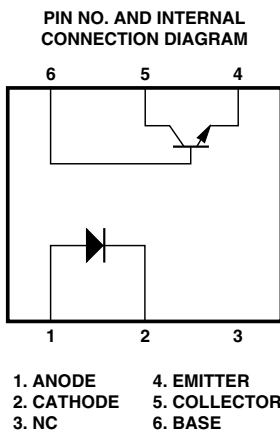

Schematic

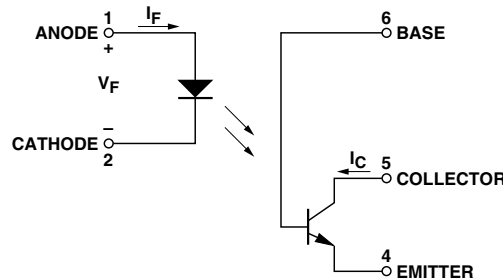

Applications

- I/O interfaces for computers
- System appliances, measuring instruments
- Signal transmission between circuits of different potentials and impedances

CAUTION: It is advised that normal static precautions be taken in handling and assembly of this component to prevent damage and/or degradation which may be induced by ESD.

Package Outline Drawings
4N25-000E

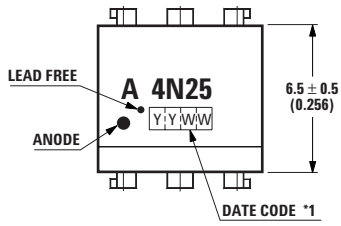

DIMENSIONS IN MILLIMETERS AND (INCHES)

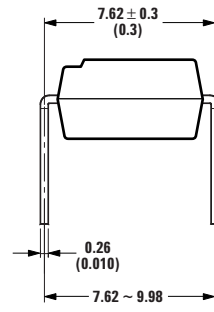
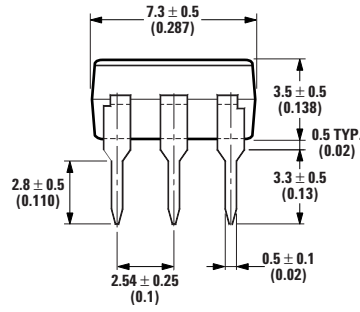

4N25-060E

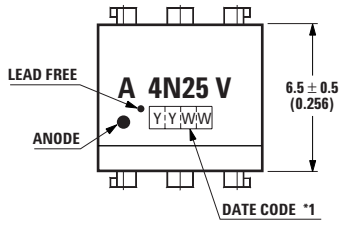

DIMENSIONS IN MILLIMETERS AND (INCHES)

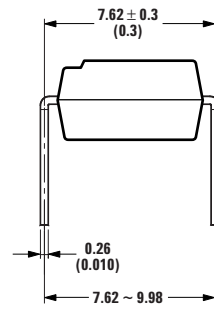
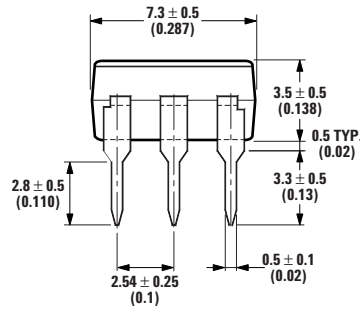

4N25-W00E

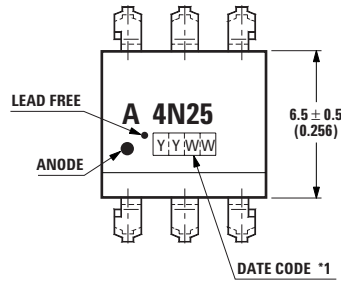

DIMENSIONS IN MILLIMETERS AND (INCHES)

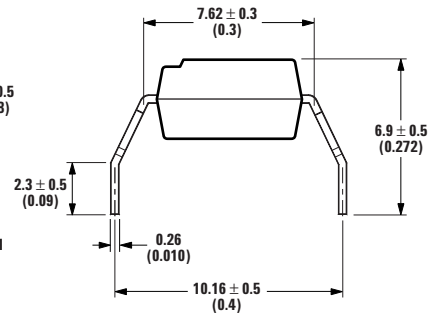
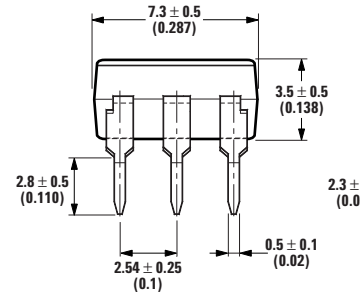

4N25-300E

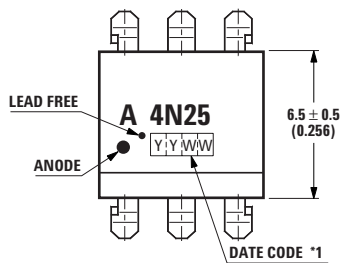

DIMENSIONS IN MILLIMETERS AND (INCHES)

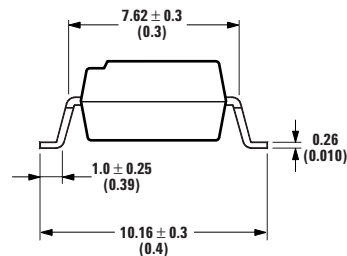
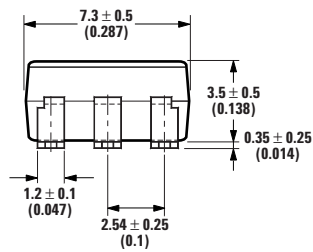

Solder Reflow Temperature Profile

- 1) One-time soldering reflow is recommended within the condition of temperature and time profile shown at right.
- 2) When using another soldering method such as infrared ray lamp, the temperature may rise partially in the mold of the device. Keep the temperature on the package of the device within the condition of (1) above.

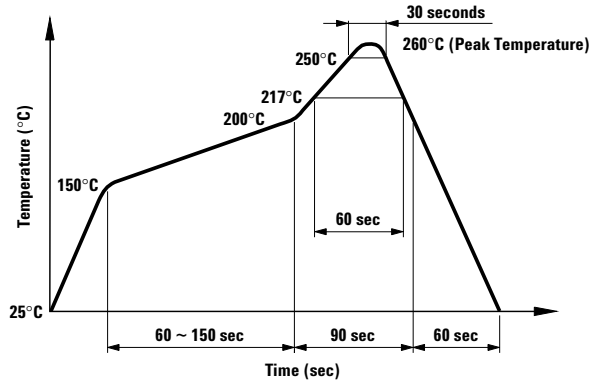

Absolute Maximum Ratings

Storage Temperature, T _S	-55°C to +150°C
Operating Temperature, T _A	-55°C to +100°C
Lead Solder Temperature, max. (1.6 mm below seating plane)	260°C for 10 s
Average Forward Current, I _F	80 mA
Reverse Input Voltage, V _R	6 V
Input Power Dissipation, P _I	150 mW
Collector Current, I _C	100 mA
Collector-Emitter Voltage, V _{CE0}	30 V
Emitter-Collector Voltage, V _{EC0}	7 V
Collector-Base Voltage, V _{CB0}	70 V
Collector Power Dissipation	150 mW
Total Power Dissipation	250 mW
Isolation Voltage, V _{iso} (AC for 1 minute, R.H. = 40 ~ 60%)	2500 Vrms

Electrical Specifications (T_A = 25°C)

Parameter	Symbol	Min.	Typ.	Max.	Units	Test Conditions
Forward Voltage	V _F	–	1.2	1.5	V	I _F = 10 mA
Reverse Current	I _R	–	–	10	μA	V _R = 4 V
Terminal Capacitance	C _t	–	50	–	pF	V = 0, f = 1 KHz
Collector Dark Current	I _{CEO}	–	–	50	nA	V _{CE} = 10 V, I _F = 0
Collector-Emitter Breakdown Voltage	BV _{CEO}	30	–	–	V	I _C = 0.1 mA, I _F = 0
Emitter-Collector Breakdown Voltage	BV _{ECO}	7	–	–	V	I _E = 10 μA, I _F = 0
Collector-Base Breakdown Voltage	BV _{CBO}	70	–	–	V	I _C = 0.1 mA, I _F = 0
Collector Current	I _C	2	–	–	mA	I _F = 10 mA
*Current Transfer Ratio	CTR	20	–	–	%	V _{CE} = 10 V
Collector-Emitter Saturation Voltage	V _{CE(sat)}	–	0.1	0.5	V	I _F = 50 mA, I _C = 2 mA
Response Time (Rise)	t _r	–	3	–	μs	V _{CE} = 10 V, I _C = 2 mA
Response Time (Fall)	t _f	–	3	–	μs	R _L = 100 Ω
Isolation Resistance	R _{iso}	5 x 10 ¹⁰	1 x 10 ¹¹	–	Ω	DC 500 V 40 ~ 60% R.H.
Floating Capacitance	C _f	–	1	–	pF	V = 0, f = 1 MHz

$$* \text{CTR} = \frac{I_C}{I_F} \times 100\%$$

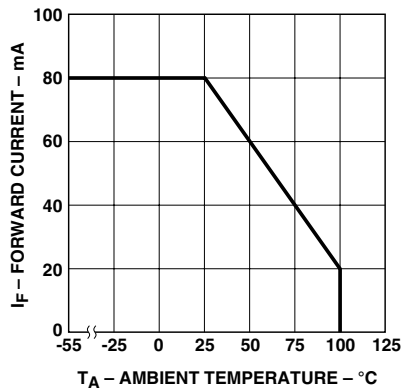

Figure 1. Forward current vs. temperature.

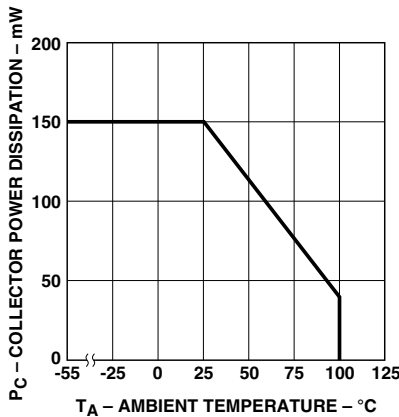

Figure 2. Collector power dissipation vs. temperature.

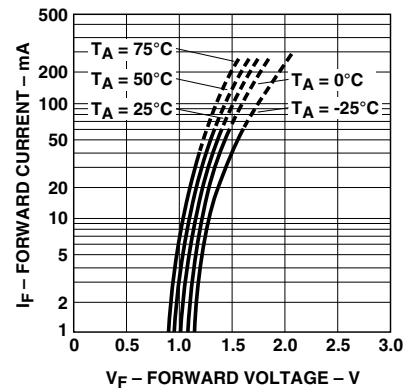

Figure 3. Forward current vs. forward voltage.

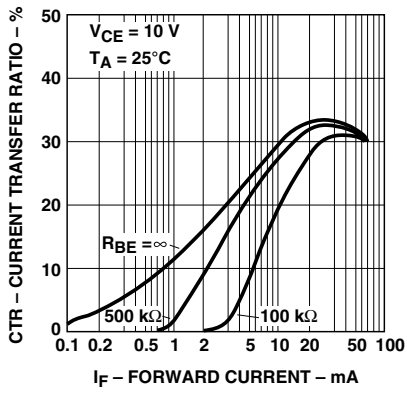

Figure 4. Current transfer ratio vs. forward current.

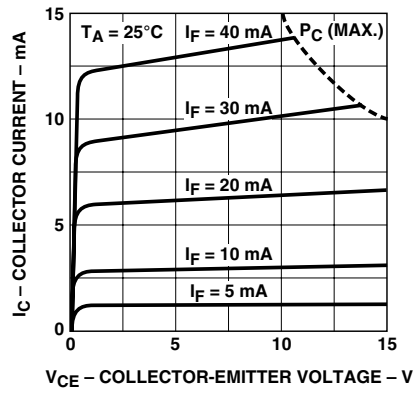

Figure 5. Collector current vs. collector-emitter voltage.

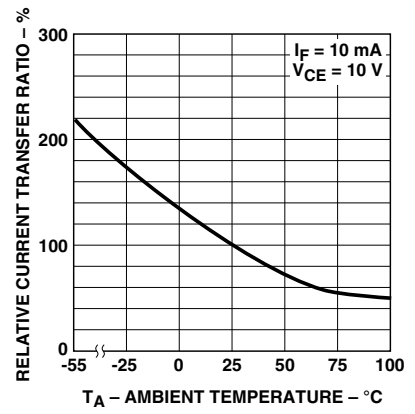

Figure 6. Relative current transfer ratio vs. temperature.

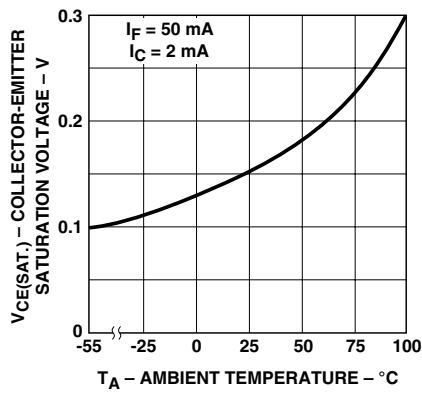

Figure 7. Collector-emitter saturation voltage vs. temperature.

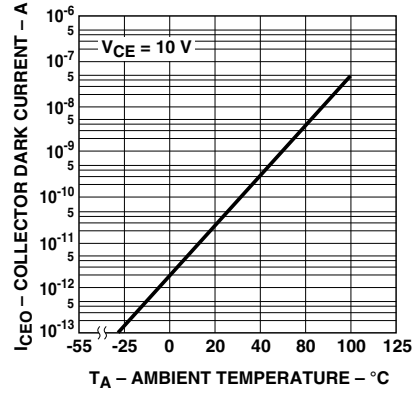

Figure 8. Collector dark current vs. temperature.

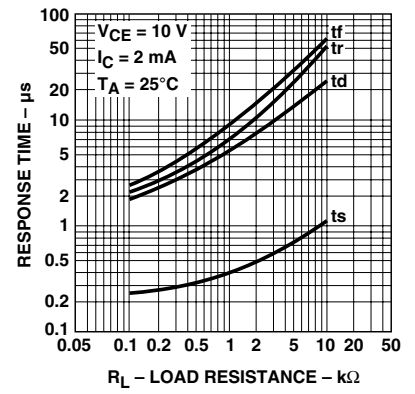

Figure 9. Response time vs. load resistance.

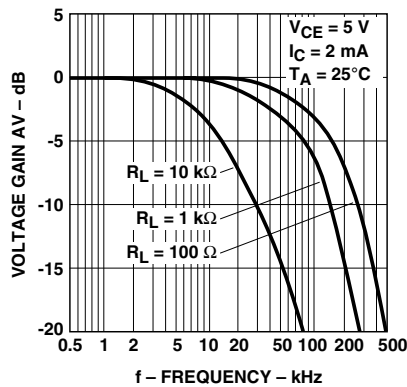

Figure 10. Frequency response.

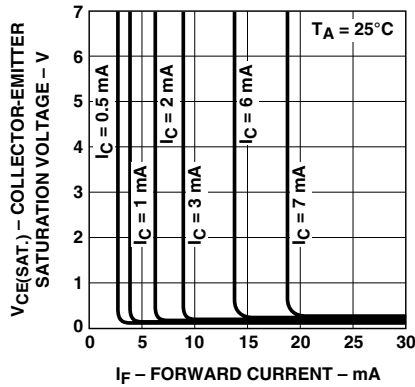
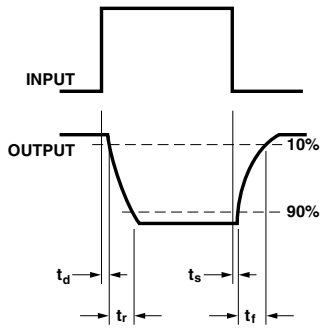
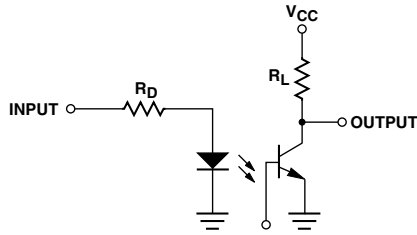
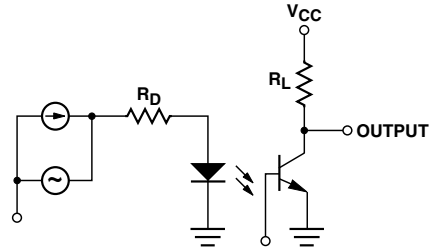

Figure 11. Collector-emitter saturation voltage vs. forward current.

Test Circuit for Response Time



Test Circuit for Frequency Response



www.agilent.com/semiconductors

For product information and a complete list of distributors, please go to our web site.

For technical assistance call:

Americas/Canada: +1 (800) 235-0312 or (916) 788-6763

Europe: +49 (0) 6441 92460

China: 10800 650 0017

Hong Kong: (+65) 6756 2394

India, Australia, New Zealand: (+65) 6755 1939

Japan: (+81 3) 3335-8152 (Domestic/International), or 0120-61-1280 (Domestic Only)

Korea: (+65) 6755 1989

Singapore, Malaysia, Vietnam, Thailand, Philippines, Indonesia: (+65) 6755 2044

Taiwan: (+65) 6755 1843

Data subject to change.

Copyright © 2004 Agilent Technologies, Inc.

Obsoletes 5989-0292EN

November 3, 2004

5989-1733EN