

XC6351A

Series

Charge Pump Voltage Inverter IC



- ◆ **Operating Voltage Range** : 1.2V ~ 5.0V
- ◆ **Highly Efficient** : 90%
- ◆ **Low Power Consumption** : 310 μ A (120kHz)
- ◆ **CE (Chip Enable) function**
- ◆ **SOT-26 Package**

Applications

- Cellular and portable phones
- Miniature LCD panels
- Palmtop computers, PDAs
- Various battery powered systems

General Description

The XC6351A series are charge pump voltage inverter ICs that have 4 MOSFETs built in. Since highly efficient negative voltages can be generated with only 2 external capacitors connected, GaAs bias power supplies & OpAmp's negative power supplies etc., can be easily accommodated on a standard PCB.

A mini-molded, 6 pin, SOT-26 package provides for space saving and makes high density mounting possible.

Low power consumption and high efficiency make this series perfect for use with battery operated applications.

Since the IC's operations stop when output is shutdown via the CE (chip enable) function, total power consumption reduction is possible in applications which use this IC.

Features

- Operating Voltage Range** : 1.2V ~ 5.0V
- Oscillator Frequency** : 120kHz
: 35kHz (custom)
- Low Supply Current** : 310 μ A (TYP)
: 100 μ A (TYP ; 35kHz)
- High Efficiency** : 90% (typ) (RL = 2k Ω)
- Stand-by Current** : 2.0 μ A (max.)
- Ultra Small Package** : SOT-26 mini mold

Typical Application Circuit

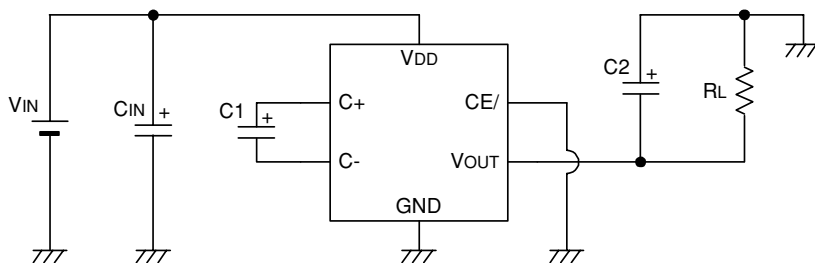

Typical Performance Characteristic

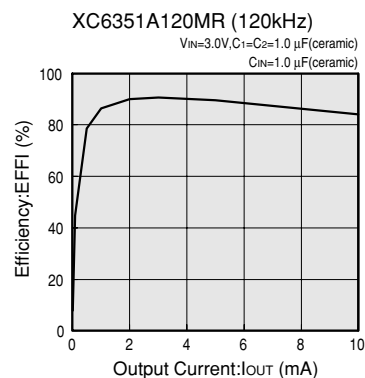

Pin Configuration

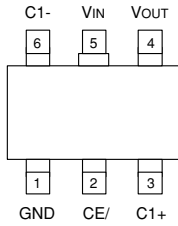

SOT-26
(TOP VIEW)

Pin Assignment

PIN NUMBER	SYMBOL	FUNCTION
1	GND	Ground
2	CE/	Chip Enable (Low Active)
3	C1+	External Capacitor +Pin
4	VOUT	Reverse Output
5	VIN	Power Supply
6	C1-	External Capacitor -Pin

Product Classification

Ordering Information

X C 6 3 5 1 A ①②③④⑤

SYMBOL	DESCRIPTION	
①②③	120	Oscillation frequency 120kHz
	035	Oscillation frequency 35kHz (custom)
④	M	Package SOT-26
⑤	R	Embossed Tape Standard feed
	L	Embossed Tape Reverse feed

8

Packaging Information

SOT-26

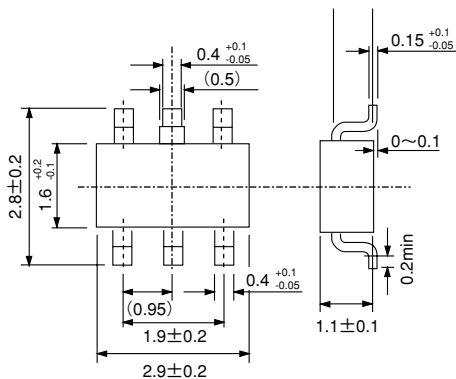

Marking

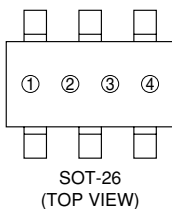

① Represents the product series

DESIGNATOR	PRODUCT NAME
A	XC6351A* * * M *

②, ③ Represents the Oscillator frequency

DESIGNATOR		Oscillator frequency	PRODUCT NAME
②	③		
0	3	35kHz	XC6351A035M *
1	2	120kHz	XC6351A120M *

④ Denotes the production lot number

0 to 9, A to Z repeated(G.I.J.O.Q.W excepted)

Block Diagram

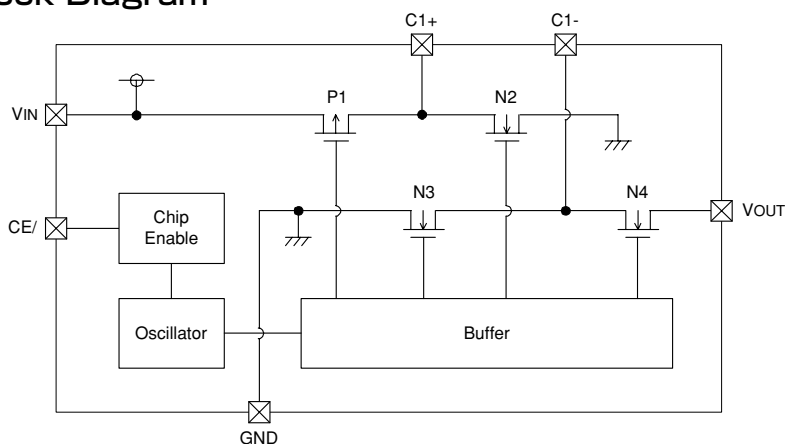

Note :

- In operation, the following conditions will be repeated alternately :
P1 & N3 ON : N2 & N4 OFF
P1 & N3 OFF : N2 & N4 ON
- In standby mode, P1, N3 & N4 will be ON and N2 will be OFF.
The output pin VOUT will be connected to GND.

Absolute Maximum Ratings

Ta = 25°C, GND = 0V

PARAMETER	SYMBOL	RATINGS	UNITS
V _{IN} input voltage	V _{IN}	6	V
V _{OUT} pin voltage	V _{OUT}	-6 ~ 0.3	V
C1+ pin voltage	C1+	-0.3 ~ V _{IN} + 0.3	V
C1- pin voltage	C1-	V _{OUT} - 0.3 ~ 0.3	V
CE/ pin voltage	CE/	-0.3 ~ V _{IN} + 0.3	V
OUT pin current	I _{OUT}	50	mA
Continuous Total Power Dissipation	P _d	150	mW
Ambient Operating Temperature	T _{opr}	-30 ~ +80	°C
Storage Temperature	T _{stg}	-40 ~ +125	°C

Electrical Characteristics

FOSC=120kHz

Ta=25°C

PARAMETER	SYMBOL	CONDITIONS	MIN	TYP	MAX	UNITS	CIRCUIT
Supply Current	IDD			310	520	μA	1
Operating Voltage Range	VIN	RL=5kΩ	1.2		5.0	V	2
Oscillation Frequency	FOSC		75	120	192	kHz	1
Power Transition Efficiency	EFFI	RL=2kΩ		90		%	2
Voltage Transition Efficiency	VEFFI	RL=∞	95			%	2
Output Impedence	ROUT	RL=5kΩ		45	90	Ω	2
Stand -By Current	ISTB	CE/=VIN			2.0	μA	3
CE/ 'H' Level Voltage	VCEH		0.9			V	3
CE/ 'L' Level Voltage	VCEL				0.25	V	3

Measuring Conditions : Unless otherwise stated, VIN = 5.0V, CE/ = 0V

Typical Application Circuit

Standard Circuit

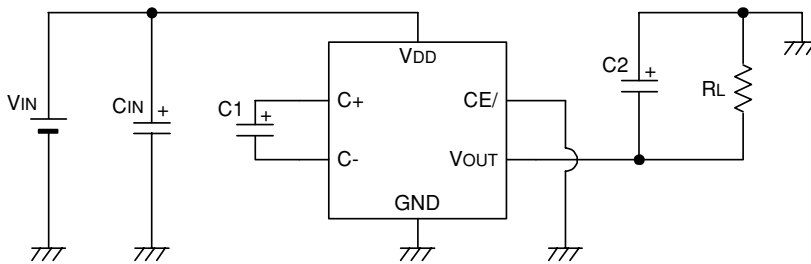

Peripherals :

CIN = 1μF (ceramic capacitor)

C1 = C2 = 1μF (ceramic capacitor)*

* With the custom 35kHz frequency, C1 = C2 = 3.3 μF

Directions for use

Notes on Use

1. Please use the IC & peripherals within the specified electrical characteristic ranges and ensure that absolute maximum ratings are not exceeded.
2. For C1 & C2, please use a capacitor with as small an ESR value as possible.
3. In order to reduce impedance between the IC's input pin and the power supply, we recommend that a capacitor (CIN) be connected to the input side.
4. If an external power supply is applied to the output pin in order to have VOUT connected to GND during standby, large current flows through the IC are a possibility.
Further, do not use a capacitor at C2 that has a large capacitance value.

Test Circuits

Circuit 1

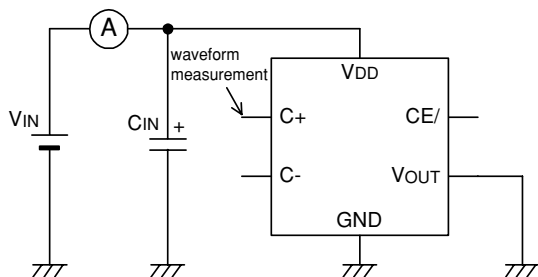

Circuit 2

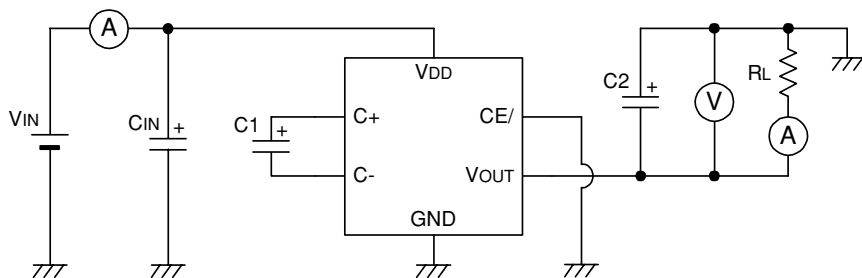

Circuit 3

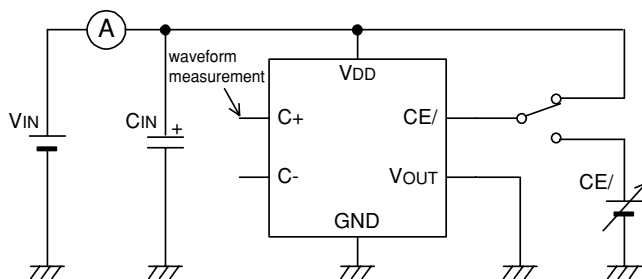

Peripherals :

$C_{IN} = 1 \mu\text{F}$ (ceramic capacitor)

$C_1 = C_2 = 1 \mu\text{F}$ (ceramic capacitor)*

* With the custom 35kHz frequency, $C_1 = C_2 = 3.3 \mu\text{F}$

Typical Performance Characteristics

(1) OUTPUT VOLTAGE vs. OUTPUT CURRENT

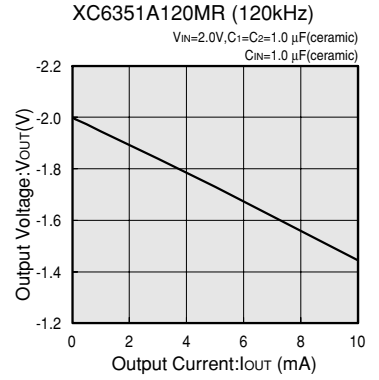
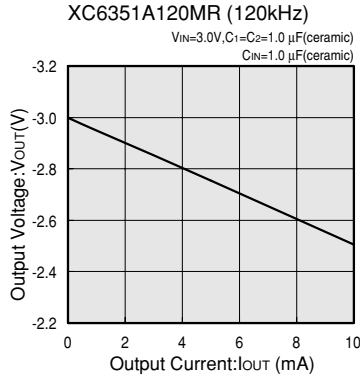
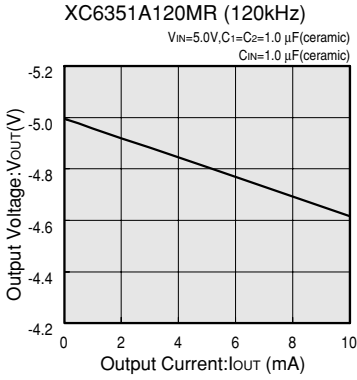

(2) EFFICIENCY vs. OUTPUT CURRENT

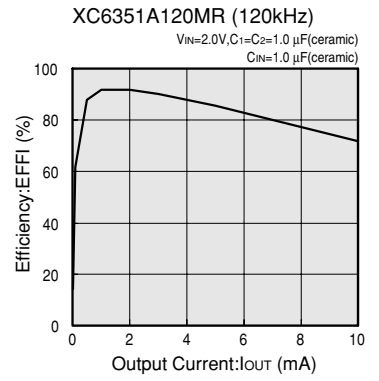
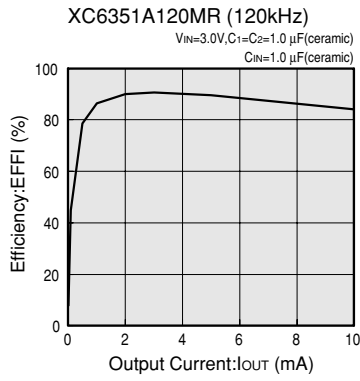
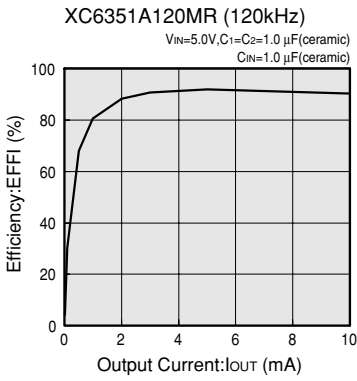

(3) OSCILLATION FREQUENCY vs. AMBIENT TEMPERATURE

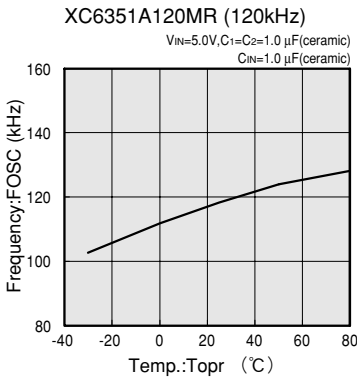

(4) OSCILLATION FREQUENCY vs. INPUT VOLTAGE

