



MODEL 18D/E

Description:Phase-Angle SCR Power Controls

Product Range:120 to 600 VAC, Single- or Three-Phase, 10 to 1200 amps

Application:Constant Resistance Loads

FEATURES

All Solid State Construction
Exclusive "2 Millisecond" Fuses for Short-Circuit Protection
Exclusive " V_{bo} Clamping" Transient Voltage Protection
Exclusive Full Rated Operation in 50°C (122°F) Ambients Without Fans Through 450 Amps
Exclusive Proprietary Heatsinks
Silent, Arcless Switching
Infinitely Variable Voltage Control
Open-Chassis or Enclosed
Full Range of Control Options and Accessories

TYPICAL APPLICATIONS

Replace Variable Transformers
Electric Furnaces and Ovens
Heat Sealing and Packaging
Ink Drying
Foam Cutting
Plastic Extruding and Molding
Process Heating
Food Processing Ovens
Autoclaves

Model 18D/E SCR controls provide infinitely variable control of single-phase (18D) and three-phase (18E) a.c. voltages to resistive heating elements. These units are solid state replacements for variable transformers, saturable core reactors, electromechanical contactors, and mercury relays. Power semiconductors replace contacts and brushes to switch electric power without moving parts, and, when operated within stated ratings for current, voltage, and temperature, have no known MTBF or life expectancy rating.

INNOVATIVE ADVANCED TECHNOLOGY: Three Pillars Of Protection

18D/E SCR controls incorporate exclusive design features to protect the power semiconductor components against damage:

- 1> Unique " V_{bo} Clamping" provides unmatched protection for power semiconductors against transient voltage spikes common on industrial power mains.
- 2> "2 millisecond" fuses protect semiconductors against short-circuit faults. Payne Engineering SCR controls are the only power controls in the industry equipped with factory tested and approved fuses coordinated with power semiconductors.
- 3> Proprietary heatsinks are engineered in-house coordinating finite element analysis (FEA) with on-site lab tests. Payne Engineering SCR controls operate at 50°C (122°F) ambient temperatures with no derating.

APPLICATION FLEXIBILITY

Standard configuration of all 18D/E controls is for manual control via a 270° turn potentiometer (included). Standard options allow for open- or closed-loop automatic control in response to an analog control signal from a temperature controller, PLC I/O module, or other external source. Other options allow controls

to be configured for the specific requirements of each application.

SPECIFICATIONS

Power Circuit: inverse-parallel semiconductors selected for V_{bo} Clamping transient protection, with parallel R-C circuit for dv/dt protection. Current-clamping 2-millisecond power fuses in series with power semiconductors provide short-circuit protection.

Control Circuit:all solid state circuitry supplies synchronized gate pulses to each thyristor via isolating pulse transformer.

Mains Frequency: 50, 60 Hz standard. Other frequencies available as special order (consult factory).

Output Voltage:0 to nominal input voltage, infinitely variable.

Overall Efficiency:98.5 to 99.5%.

Power Loss: approximately 1-2 watts/ampere/switched pole.

Voltage Drop Across Power Circuit at 100% Output:1-2 volts maximum per switched pole.

Proof Voltage:(isolation between power circuit, control circuit and ground) greater than 2 kV.

Control Input:manual control via 75K Ohm, 2 watt potentiometer with integral On/Off switch and indicating dial plate standard.

Control Power:5 watts maximum. Derived from 12 VA isolation control transformer (except for 120 VAC 18D units in 10, 20, 30 amp sizes).

Fuse Protection:2 millisecond I^2t fuses are factory tested and coordinated with all power semiconductors, considering:

- a. fuse element melt time t_{melt} ;
- b. peak melt current I_{melt} ;
- c. arc quench time t_{arc} ;
- d. peak arc current I_{arc} .

Transient Voltage Protection:voltage breakover (V_{bo}) protection with R-C filters for dv/dt protection.

Ambient Temperature Range:0 to $+50^{\circ}\text{C}$ (122°F).

Terminal Connections 10-30 amp use Bakelite or thermoplastic blocks; 50 amps and larger use screw lugs or stud bolts.

STANDARD OPTIONS

RMS Voltage Limit: circuit-board mounted variable-resistance trimmer in series with manual potentiometer. Allows the user to limit output voltage to connected load at maximum potentiometer setting. Not applicable to units controlled by external analog signal.

Milliamp Control: circuitry integral to main control board that allows output voltage to be controlled by external analog signal (milliamps or d.c. voltage) in closed-loop system. Voltage output from power control is proportional to analog signal input. Multi-turn SPAN and GAIN trimmers provide for field calibration/adjustment of signal response range.

Output Current Limit: output voltage from control is varied to keep load current at or below adjustable limit. Includes current transformer.

RMS Output Voltage Regulation: output voltage variations are limited to 1% for input variations up to 30%. Maximum regulated output voltage may not be greater than 75% of minimum input voltage.

Isolated Chassis Construction: electrically isolated chassis available through 80 amp size. Note: 18D controls with "i" suffix in model number include isolated chassis construction as standard feature.

Thermistor Control: control accepts input from temperature-sensing thermistor probe, and automatically adjusts power control output voltage to maintain load temperature at level selected on temperature set potentiometer in closed-loop control scheme. Available temperature ranges: 0-90°C and 90-240°C. Thermistor probe, 3 ft. of cable, and set-point potentiometer included.

Soft-Start: output voltage to load is ramped from 0 to potentiometer-selected level over 1/2 second after

actuation to reduce inrush currents. Operates upon closure of On/Off switch in potentiometer and main power activation; must be reset by opening same switch or removing main power before operating again.

Optically Isolated ma. Control Card: circuit card for field retrofit of manually operated controls for automatic control in response to external analog milliamp signal. Optically isolated circuit permits use in open- or closed-loop control schemes. Voltage output from power control is proportional to analog signal input. Multi-turn SPAN and GAIN trimmers provided for field calibration/adjustment of signal response range.

Retrofit: 18D (120 and 240 VAC, to 30 amps) as built prior to 8/90.

Heatsink Overtemperature Switch: temperature sensor mounted to heatsink switches if heatsink temperature exceeds maximum allowable level. Available to turn off control or drive external indicating signal.

120 V Pilot: 120 VAC pilot voltage used to actuate control.

70-400 Hz: control configured for operation at frequencies ranging from 70-400 Hz, or 16-2/3 and 25 Hz.

277 VAC Input: unit rated for single-phase 277 VAC input.

550 VAC Input: unit rated for 550 VAC input (+10% max.).

600 VAC Input: unit rated for 600 VAC input (+10% max.).

ENCLOSURES

18D/E power controls can be supplied in a steel electrical enclosure with hinged front cover. Enclosures are ventilated to facilitate proper cooling of the control. Ventilation openings are covered by expanded metal mesh, and located in the bottom and the top of the side panels. Enclosure fans are not required. For non-ventilated enclosure requirements, consult local sales office.

SIZING CONSIDERATIONS

Model 18D/E SCR power controls are designed for use on constant-resistance loads only. Size units by actual load current, not kW.

1> Always use maximum possible load current for sizing purposes.

2> The amp rating on all power controls is determined by the fuse(s). Current draw must not exceed the fuse rating at any time.

3> Rated voltage of the connected load should match the input voltage to the power control.

SIZING EXAMPLE

Application: proportional control of three-phase, 480 VAC, delta-connected 15 kW constant-resistance heating elements; 480 VAC, three-phase, 60 Hz input voltage.

Model Number Selection:

- Variable-voltage: 18
- Three-phase: E
- 480 VAC input: -4-
- Amp rating, calculated as follows:

$$15.0 \times 1000 = 18.06 \text{ amps/phase} \\ 480 \times 1.73$$

Since $18.06 < 20$, amp rating: 20

Model Number: 18E-4-20

Options: as required.

WHEN ORDERING, SPECIFY:

Model Number
Input Voltage
Frequency
Load Specifications
Options
Enclosure Requirements

Model Number	Amps (Fuse)	KVA @ Max. Rated Voltage	Fuse Number	Open Chassis Dimensions Inches (millimeters)			Enclosed Dimensions Inches (millimeters)		
				Height	Width	Depth	Height	Width	Depth
Single-Phase, 120 VAC, 50/60 Hz Input, 0-118 VAC Output									
18D-1-10i	10	1.2	49B25-10	6.25 (159)	3.5 (89)	3 (76)	10 (254)	6 (153)	6 (153)
18D-1-20i	20	2.4	49B25-20	6.25 (159)	3.5 (89)	3 (76)	10 (254)	6 (153)	6 (153)
18D-1-30i	30	3.6	49B25-30	6.25 (159)	3.5 (89)	4.1 (114)	10 (254)	6 (153)	6 (153)
18D-1-50	50	5.9	49A50-50	12 (305)	5.5 (140)	7 (178)	14 (356)	12 (305)	8 (203)
18D-1-80	80	9.4	49A50-80	12 (305)	5.5 (140)	7 (178)	14 (356)	12 (305)	8 (203)
18D-1-120	120	14.1	49A50-125	12.5 (317)	6.5 (165)	8.5 (216)	20 (508)	16 (407)	9 (229)
18D-1-150	150	17.7	49A50-150	15 (381)	9.5 (241)	8.5 (216)	20 (508)	16 (407)	9 (229)
18D-1-250	250	30.0	49A50-250	25 (635)	9.5 (241)	8.5 (216)	30 (762)	20 (508)	9 (229)
18D-1-350	350	41.3	49A50-350	21 (534)	13 (331)	10.5 (267)	36 (915)	24 (610)	12 (305)
Single-Phase, 208/220/240 VAC, 50/60 Hz Input, 0-206/218/238 VAC Output									
18D-2-10i	10	2.4	49B25-10	6.25 (159)	3.5 (89)	3 (76)	10 (254)	6 (153)	6 (153)
18D-2-15i	15	3.6	49B25-15	6.25 (159)	3.5 (89)	3 (76)	10 (254)	6 (153)	6 (153)
18D-2-20i	20	4.8	49B25-20	6.25 (159)	3.5 (89)	3 (76)	10 (254)	6 (153)	6 (153)
18D-2-30i	30	7.2	49B25-30	6.25 (159)	3.5 (89)	4.1 (114)	10 (254)	6 (153)	6 (153)
18D-2-50	50	11.9	49A50-50	12 (305)	5.5 (140)	7 (178)	14 (356)	12 (305)	8 (203)
18D-2-80	80	19.0	49A50-80	12 (305)	5.5 (140)	7 (178)	14 (356)	12 (305)	8 (203)
18D-2-120	120	28.5	49A50-125	12.5 (317)	6.5 (165)	8.5 (216)	20 (508)	16 (407)	9 (229)
18D-2-150	150	35.7	49A50-150	15 (381)	9.5 (241)	8.5 (216)	20 (508)	16 (407)	9 (229)
18D-2-250	250	60.0	49A50-250	25 (635)	9.5 (241)	8.5 (216)	30 (762)	20 (508)	9 (229)
18D-2-350	350	83.3	49A50-350	21 (534)	13 (331)	10.5 (267)	36 (915)	24 (610)	12 (305)
Single-Phase, 380/415/440/480 VAC, 50/60 Hz Input, 0-378/413/438/478 VAC Output									
18D-4-10	10	4.8	49B70-10	7 (178)	5.5 (140)	4.5 (114)	12 (305)	10 (254)	6 (153)
18D-4-20	20	9.6	49B70-20	7 (178)	5.5 (140)	4.5 (114)	12 (305)	10 (254)	6 (153)
18D-4-30	30	14.4	49B70-30	7 (178)	5.5 (140)	5.5 (140)	12 (305)	10 (254)	6 (153)
18D-4-50	50	23.9	49A50-50	12 (305)	5.5 (140)	7 (178)	14 (356)	12 (305)	8 (203)
18D-4-80	80	38.2	49A50-80	12 (305)	5.5 (140)	7 (178)	14 (356)	12 (305)	8 (203)
18D-4-120	120	57.3	49A50-125	12.5 (317)	6.5 (165)	8.5 (216)	20 (508)	16 (407)	9 (229)
18D-4-150	150	71.7	49A50-150	15 (381)	9.5 (241)	8.5 (216)	20 (508)	16 (407)	9 (229)
18D-4-250	250	120.0	49A50-250	25 (635)	9.5 (241)	8.5 (216)	30 (762)	20 (508)	9 (229)
18D-4-350	350	167.0	49A50-350	21 (534)	13 (331)	10.5 (267)	36 (915)	24 (610)	12 (305)
18D-4-450	450	215.0	49A50-450	27 (686)	17 (432)	10.5 (267)	36 (915)	24 (610)	12 (305)
18D-4-600	600	288.0	49A50-600	27 (686)	17 (432)	10.5 (267)	36 (915)	24 (610)	12 (305)
18D-4-1200	1200	576.0	(2) 49A50-600	47 (1194)	21 (534)	10.5 (267)	90 (2286)	36 (915)	20 (508)

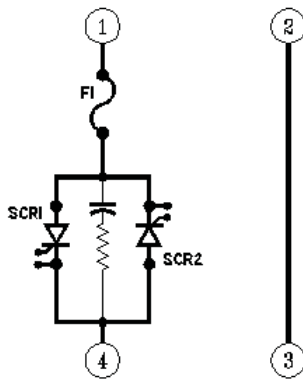

POWER CIRCUIT SCHEMATIC

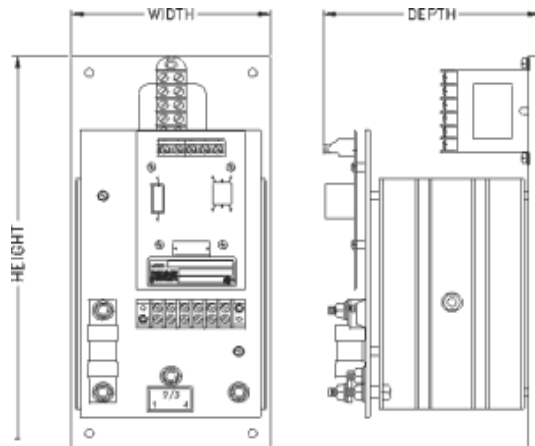

OPEN CHASSIS DIMENSIONS

Model Number	Amps (Fuse)	KVA @ Max. Rated Voltage	Fuse Number	Open Chassis Dimensions Inches (millimeters)			Enclosed Dimensions Inches (millimeters)		
				Height	Width	Depth	Height	Width	Depth
Three-Phase, 208/220/240 VAC, 50/60 Hz Input, 0-188/200/220 VAC Output									
18E-2-10	10	4	49B25-10	10.62 (270)	8.25 (210)	5.37 (137)	14 (356)	12 (305)	8 (203)
18E-2-20	20	8	49B25-20	12.62 (321)	10.25 (260)	5.37 (137)	14 (356)	12 (305)	8 (203)
18E-2-30	30	12	49B25-30	15.1 (385)	12.87 (286)	6.37 (162)	20 (508)	16 (407)	9 (229)
18E-2-50	50	20	49A50-50	15 (381)	13 (330)	6.25 (159)	20 (508)	16 (407)	9 (229)
18E-2-80	80	32	49A50-80	21 (533)	13 (330)	6.25 (159)	24 (610)	16 (407)	9 (229)
18E-2-120	120	48	49A50-125	21 (533)	13 (330)	8.25 (210)	30 (762)	20 (508)	9 (229)
18E-2-150	150	60	49A50-150	27 (685)	17 (431)	8.25 (210)	36 (915)	24 (610)	10 (254)
18E-2-250	250	100	49A50-250	27 (685)	21 (533)	9 (229)	36 (915)	24 (610)	10 (254)
18E-2-350	350	139	49A50-350	27 (685)	27 (685)	12 (305)	42 (1067)	30 (762)	12 (305)
18E-4-450	450	180	49A50-450	33 (838)	27 (685)	12 (305)	42 (1067)	36 (915)	12 (305)
18E-4-600	600	239	49A50-600	39 (991)	27 (685)	12.5 (318)	48 (1220)	36 (915)	12 (305)
18E-4-1200	1200	478	(2) 49A50-600	57 (1448)	33 (838)	12.5 (318)	90 (2286)	36 (915)	20 (508)
Three-Phase, 380/415/440/480 VAC, 50/60 Hz Input, 0-360/395//420/460 VAC Output									
18E-4-10	10	8	49B70-10	10.62 (270)	8.25 (210)	5.37 (137)	14 (356)	12 (305)	8 (203)
18E-4-20	20	16	49B70-20	12.62 (321)	10.25 (260)	5.37 (137)	14 (356)	12 (305)	8 (203)
18E-4-30	30	24	49B70-30	15.1 (385)	12.87 (286)	6.37 (162)	20 (508)	16 (407)	9 (229)
18E-4-50	50	40	49A50-50	15 (381)	13 (330)	6.25 (159)	20 (508)	16 (407)	9 (229)
18E-4-80	80	64	49A50-80	21 (533)	13 (330)	6.25 (159)	24 (610)	16 (407)	9 (229)
18E-4-120	120	96	49A50-125	21 (533)	13 (330)	8.25 (210)	30 (762)	20 (508)	9 (229)
18E-4-150	150	120	49A50-150	27 (685)	17 (431)	8.25 (210)	36 (915)	24 (610)	10 (254)
18E-4-250	250	200	49A50-250	27 (685)	21 (533)	9 (229)	36 (915)	24 (610)	10 (254)
18E-4-350	350	278	49A50-350	27 (685)	27 (685)	12 (305)	42 (1067)	30 (762)	12 (305)
18E-4-450	450	359	49A50-450	33 (838)	27 (685)	12 (305)	42 (1067)	36 (915)	12 (305)
18E-4-600	600	478	49A50-600	39 (991)	27 (685)	12.5 (318)	48 (1220)	36 (915)	12 (305)
18E-4-1200	1200	965	(2) 49A50-600	57 (1448)	33 (838)	12.5 (318)	90 (2286)	36 (915)	20 (508)

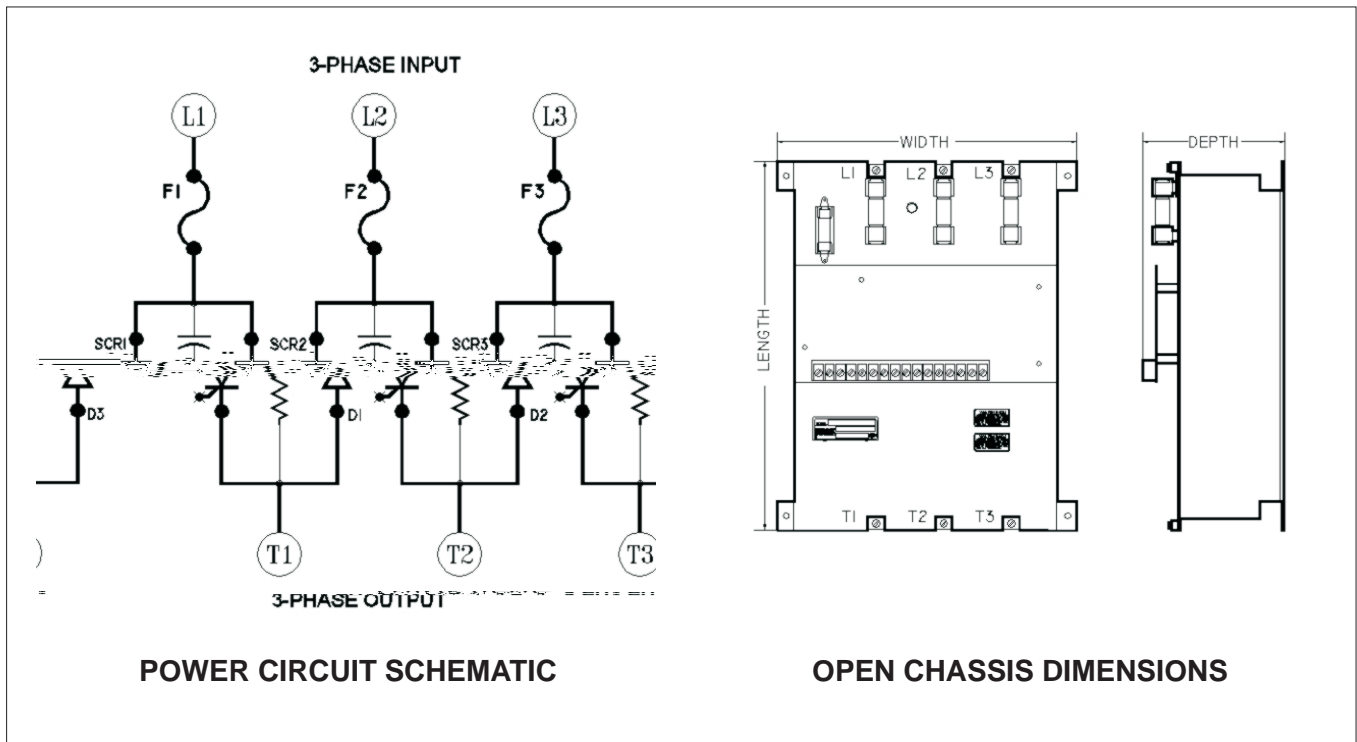

All dimensions are approximate, and are not to be used for construction purposes. Payne Engineering Company Inc. reserves the right to make changes to product design, construction, and component parts in the interest of technical advancement without prior notification.