

Conductive Level Controller 61F-D21T-V1

CSM_61F-D21T-V1_DS_E_1_1

Ideal for level control for industrial facilities and equipment.

- Outputs can be set to self-hold at ON or OFF using self-holding circuits.
- Sensitivity adjustment of operating resistance from 10 to 100 k Ω for application to a wide range of liquids.
- Delay timer to prevent relay contact chattering caused by waves.
- Models with a wide AC power supply range (100 to 240 VAC) and 24 VAC/DC reduce the number of level controller models kept in stock.
- CE marking, cUL recognized.
- Easy wiring with ferrules
2 × 2.5 mm² solid or 2 × 1.5 mm² standard ferrules.



Model Number Structure

■ Model Number Legend

61F-□□
1 2 3

1. Basic Model

61F: Conductive Level Controller

2. Functions

D21T-V1: Automatic liquid supply operation/
Automatic liquid drainage operation

3. Supply Voltage

24 VAC/DC: 24 VAC/DC
100-240 VAC: 100 to 240 VAC

Ordering Information

■ List of Models

Conductive Level Controller	Supply voltage	Model
	24 VAC/DC	61F-D21T-V1 24 VAC/DC
	100 to 240 VAC	61F-D21T-V1 100 to 240 VAC

Specifications

Rated voltage	24 VAC, 50/60 Hz, or 24 VDC 100 to 240 VAC, 50/60 Hz
Operating voltage range	85% to 110% of rated voltage
Voltage between electrodes	6 V p-p (approx. 20 Hz)
Power consumption	24 VDC: 2 W max. 24 VAC: 4 VA max. 100 to 240 VAC: 5 VA max.
Operating resistance	10 kΩ to 100 kΩ (variable)
Reset resistance	250 kΩ max.
Response time	Approx. 0.1 to 10 s (variable)
Cable length	100 m max. with completely insulated (600 V) cable with 3 conductors (0.75 mm ²)
Control output	6 A at 250 VAC for resistive load at 20°C, 1 A at 250 VAC for inductive load $\cos\phi = 0.4$ at 20°C
Indicators	Green LED: Power, Yellow LED: Control output
Ambient temperature	Operating: -20 to 60°C, Storage: -30 to 70°C (with no condensation or icing)
Ambient humidity	Operating: 25% to 85%, Storage: 25% to 85%
Elevation	2,000 m max.
Insulation resistance	100 MΩ min. (at 500 VDC) between power supply section, electrode section, and contact section
Dielectric strength	2,000 VAC 50/60 Hz for 1 min between power source section, electrode section, and contact section
Vibration resistance	Vibration of 10 to 55 Hz and acceleration of 50 m/s ² for 5 min. 10 times each in X, Y, and Z directions
Shock resistance	100 m/s ² 3 times each in 6 directions on 3 axes
Installation environment	Overvoltage Category II, Pollution Degree 2
Safety standards	EN61010-1
EMC	EN61326 Industrial applications

Connections

■ Operation Diagram

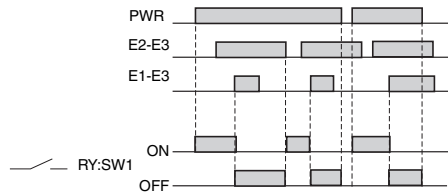

1. Water Supply (RY-SW1 ON)

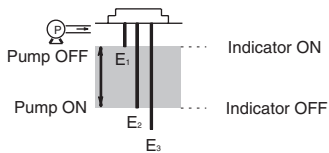

- Connect electromagnetic switch coil terminal A to terminal 2.
- The pump stops when the water level reaches E1 (indicator ON) and starts when the water level drops below E2 (indicator OFF).

■ Wiring Diagram

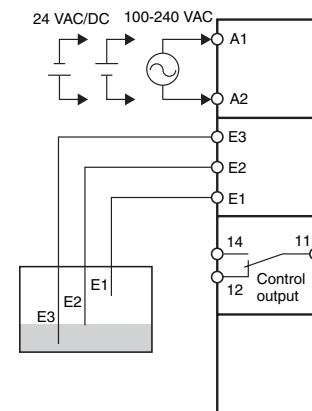

2. Drainage (RY-SW1 OFF)

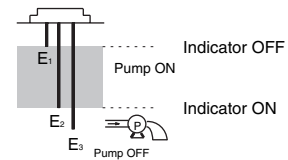

- Connect the electromagnetic switch coil terminal A to terminal 3.
- The pump starts when the water level reaches E1 (indicator OFF) and stops when the water level drops below E2 (indicator ON).

Nomenclature

■ Front

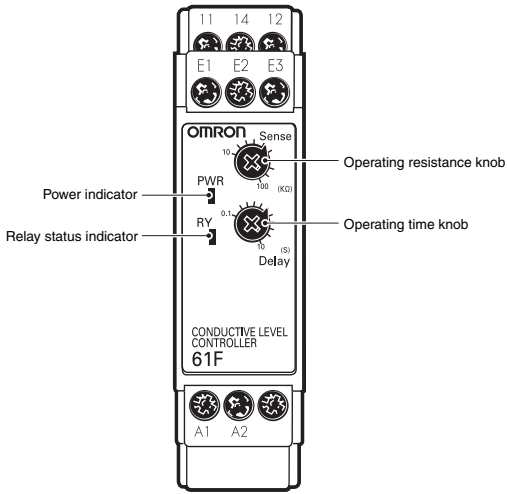

■ DIP Switch Settings

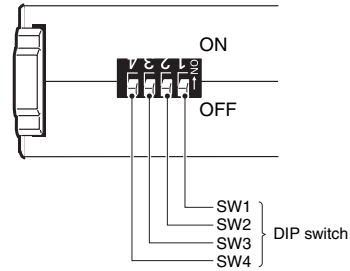

: ON : OFF

	SW			
	1	2	3	4
OFF	<input type="checkbox"/>			
ON	<input type="checkbox"/>			
NOT USED		<input type="checkbox"/>		
NOT USED			<input type="checkbox"/>	
NOT USED				<input type="checkbox"/>

Indicators

Item	Meaning
Power indicator (PWR: Green)	Lit when power is being supplied.
Relay status indicator (RY: Yellow)	Lit when relay is operating.

Setting Knobs

Item	Usage
Operating resistance knob	Used to set the operating resistance to 10 to 100 kΩ.
Operating time knob	Use to set the operating time to 0.1 to 10 s.

DIP Switch Functions

SWITCH		ON ● ↑			
		4	3	2	1
	OFF ○ ↓	<input type="checkbox"/>	<input type="checkbox"/>	<input type="checkbox"/>	<input type="checkbox"/>
Supply/ drainage selection	Automatic liquid drainage operation	Not used.	Not used.	Not used.	●
	Automatic liquid supply operation				○

Note: All pins are set to OFF at the factory.

Dimensions

61F-D21T-V1

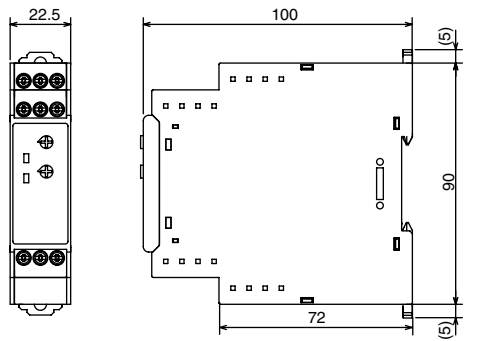

Unit: mm

*Installation Procedure: Mount to the DIN Rail or with front screws
 *Dimensions for Mounting with Front Screws

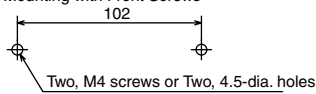

Note: When mounting with front screws, draw out the hooks on the bottom of the product on the left and right sides.

Installation Procedure

- Pull down the hook, fasten the upper tab onto the Rail, and then press the Controller onto the Rail until the hook locks into place.

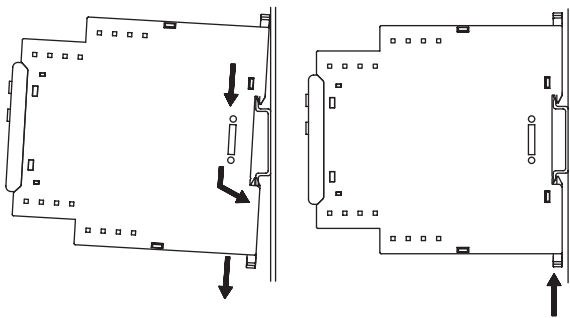

DIN Rail

Attach the 61F-D21T-V1 to a DIN Rail.

- DIN Rails: PFP-100N (1,000 mm)
PFP-50N (500 mm)

Separator

- F03-14

Recommended Crimp Terminals

Recommended crimp terminal	Recommended cable diameter
Al 1,5-8BK (Phoenix Contact)	AWG16
Al 1-8RD (Phoenix Contact)	AWG18
Al 0,75-8GY (Phoenix Contact)	AWG18

Uninstallation Procedure

- Using a flat-blade screwdriver or a similar tool, pull down the hook and lift the Controller from the bottom.

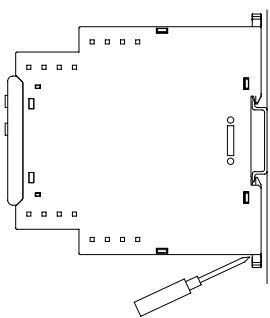

Safety Precautions

Definition of Precaution Information



Indicates a potentially hazardous situation which, if not avoided, may result in minor or moderate injury or in property damage.

Precautionary Information



Do not touch the terminals while power is being supplied.
Doing so may possibly result in electric shock.

■ Precautions for Safe Use

- Do not disassemble, repair, or modify the product.
- When attaching the product to the DIN rail, attach it firmly with screws.
- When attaching the product to the DIN rail, ensure that the product has been attached firmly.
- If the thickness of a mounting panel is not adequate, or a mistake has been made during installation, the product may become disconnected.
- Ensure that terminal screws have been tightened firmly.
Recommended torque: 0.49 N·m
Assured torque: 0.59 N·m
- When using the product, ensure that the wiring is correct before turning on the power.
- Use a power-supply voltage that is within the range of specifications.
- Use the control source and power supply or power lines that provide inputs with appropriate specifications.
- Do not install near heat-generating devices (coils, or devices that use coils).
- Be sure to confirm terminal numbers for correct wiring.
- Ensure that wiring is correct. Double-check materials such as connection charts and circuit diagrams.
- Properly ground the grounding terminal. Ensure that the common electrode terminal has been properly grounded. Doing so can alleviate effects from noise.
- If electrodes make contact with liquid, purchase and use a separator to prevent such contact.
- Keep appropriate distance from devices that generate high-frequency noise (e.g., high-frequency welders, electronic sewing machines).
- Do not turn a setting volume beyond the scope of movement.
- Do not connect anything to unused terminals.
- Use SELV power supply with over load protection function for DC power supply. The insulation of SELV power supply must be a double or reinforced between input and output. The output voltage shall be 30 V_{r.m.s.} and 42.4 V at peak, or use the power supply of 60 V DC max. Recommended power supply: type S8VS-06024□ (OMRON made)

Do not keep, install, or use this product in the following environments.

- Outdoors, or places subject to direct sunlight or wearing weather.
- Places where temperature and humidity exceed the allowable range of the product specifications.
- Places where there are extreme changes in temperature and humidity, or icing or condensation may occur.
- Places subject to static electricity or inductive noise.
- Places subject to electrical fields.
- Places where vibrations or physical shocks are strong.
- Places where flammable gasses or flammable liquids exist.
- Places where corrosive gases (in particular, sulfuric or ammonia gas) exist.
- Places with large amounts of dust or iron powders.
- Places where water or oil come in contact with the product.
- Places subject to salt-water splashes.

■ Precautions for Correct Use

For Proper Use

1. Make sure to use setting values appropriate for the controlled object. Failure to do so can cause unintended operation, and may result in accident or corruption of the product.
2. When discarding, properly dispose of the product as industrial waste.
3. Only use this product within a board whose structure allows no possibility for fire to escape.
4. To avoid damage to the exterior of the product, do not use organic solvents (thinner, benzene) or agents with strong alkalinity or acidity.

About Installation

1. When wiring, use only recommended crimp terminals.
2. Do not block areas around the product for proper dissipation of heat. (If you do not secure space for heat dissipation, life cycle of the product will be compromised.)

Noise Countermeasures

1. Do not install the product near devices generating strong high frequency waves or surges.
2. When using a noise filter, check the voltage and current and install it as close to the product as possible.
3. In order to prevent inductive noise, wire the lines connected to the product separately from power lines carrying high voltages or currents. Do not wire in parallel with or on the same cable as power lines. Other measures for reducing noise include running lines along separate ducts and using shield lines.

To avoid faulty operations, malfunctions, or failure, observe the following operating instructions.

1. During insulation resistance measurements, never apply the megohmmeter across the electrode terminals.
2. Use a power supply that will reach rated voltage within 1 second.

ALL DIMENSIONS SHOWN ARE IN MILLIMETERS.

To convert millimeters into inches, multiply by 0.03937. To convert grams into ounces, multiply by 0.03527.

In the interest of product improvement, specifications are subject to change without notice.