

84

Stopping Power

New standards in
Emergency-stop switches.

Rely on the Series 84 Emergency-stop
to prevent an accident.

- Robust** Single-piece 'monoblock' construction sealed to IP 65.
- Foolproof** Conforms to EN 418 and EN 60947-5-1.
- Compact** Low behind-panel depth for space-restricted applications.
- Bright** LED illumination visible even from a side view.
- Versatile** Illumination powered by any voltage from 5 to 30VDC.
- Clear** Switch's status clearly indicated by coloured ring on shaft.
- Reliable** Long-life and guaranteed for a minimum 50,000 operations.

EAO, the expert in Human Machine Interfaces, adds a compact, illuminated Emergency-stop switch to the Series 84 range. Built to EAO's renowned high standards, this new Emergency-stop has been designed by experts for optimal

functionality and usability throughout assembly, mounting and operation. With a low behind-panel depth, 'foolproof' monoblock design and bright LED illumination, the Series 84 represents the finest in Emergency-stops.

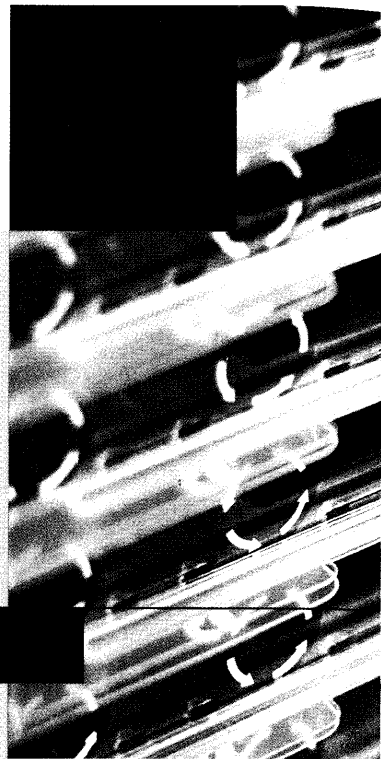

design award
winner

2004

EAO is a global manufacturer of high-quality Human Machine Interface products, from switches, keypads and keyboards to complete, custom-built control panels.

Our products have been developed by world-class industrial specialists and tested to international standards.

They are synonymous with creativity, innovation and excellence - the hallmarks of EAO.

Founded in 1947, EAO has now established a global reputation for being an expert partner for Human Machine Interfaces across a range of industries: transportation, machinery,

process control, lifting and moving, and instrumentation.

Our 10 specialised Sales and Customer Service Centres around the world and a network of trained specialist agents and representatives in more than 50 countries will bring experience, skill and dedication to your projects.

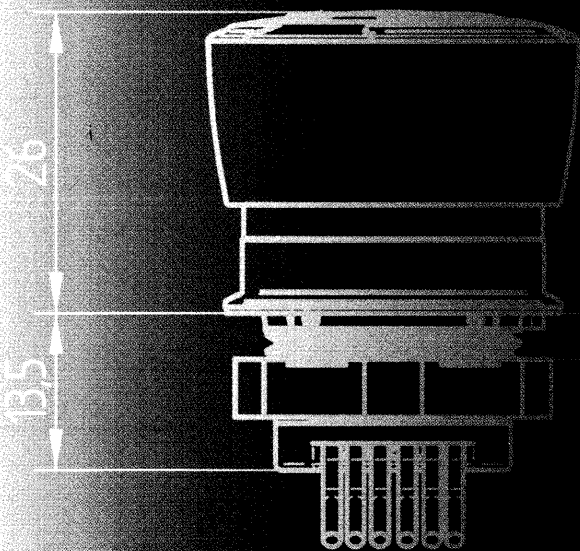

Series 84 Illuminated Emergency-stop with flying leads or plug in terminals.

84

Shut down fast

Suitable for a wide variety of industrial applications.

The finest Emergency-stop for the harshest industries.

EAO understands the needs of industry, so we've built the Series 84 Emergency-stop for versatility to satisfy the demands of both equipment builders and users. The switch is most suited to compact and hand-held control panels featured on a wide range of machinery and process control equipment, including production lines, cranes, robots, moving platforms, as well as security systems and emergency exits. The fast, easy mounting and possibility to connect to PCBs suits modern assembly techniques.



Activate in emergency

The Series 84 Emergency-stop is illuminated for visibility in polluted or dark environments.

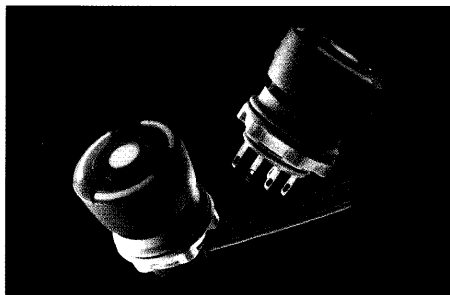

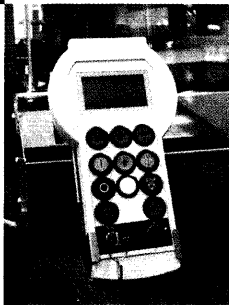

Portable controls
The Series 84 Emergency-stop is ideal for compact, hand-held controls where the depth of the back panel is critical.

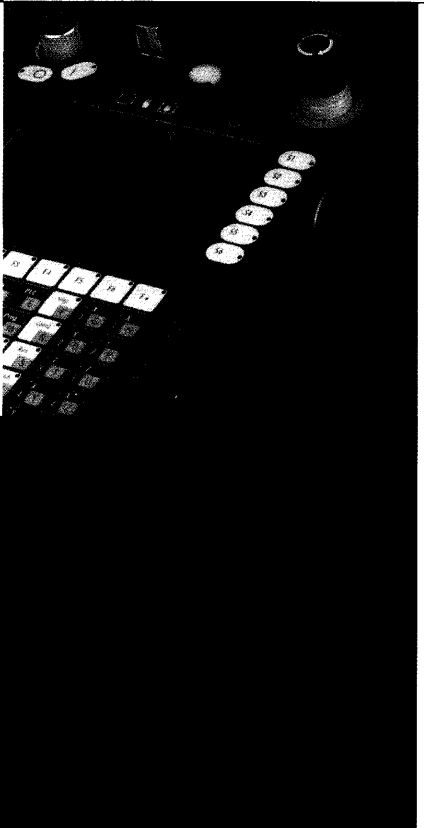

Exterior applications

The Series 84 Emergency-stop is protected against water and dirt ingress.

Unbreakable

The monoblock design will withstand high-impact activation during an emergency.

84

Perfect fit

Mounting made easy.

Mount alongside other
Series 84 products.

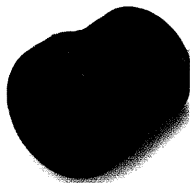
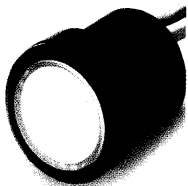
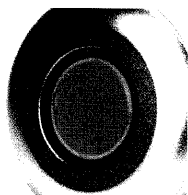

Adaptable

Adaptable to PCBs of different heights using flying leads.

Customisable

Can be supplied with variety of cable lengths and connectors.

Compatible

Use in combination with full range of EAO Series 84 pushbuttons and indicators.

The Emergency-stop switch can be mounted to a front plate with a thickness of between 1 and 4mm. It has a low behind-panel depth of 13.5mm (max) and can be safely and easily adapted to PCBs of different heights. Importantly, the Series 84 Emergency-stop requires no additional assembly because of its 'monoblock' design.

The Series 84 range includes 22.5mm pushbuttons and indicators protected up to IP67. They are suited to a range of industrial applications and guarantee reliable switching even of very light loads. For Series 84 pushbutton and indicator data please contact your local sales office.

TECHNICAL DETAILS

Mounting hole	22.5mm conforming to EN 60947-5-1 with anti-twisting cut-out	Illumination (optional)	LED, supply voltage between 5V - 30VDC Power consumption max 400mW
Degree of protection	IP65 from the front side	Lifetime	Electrical and mechanical > 50,000 operations
Temperature	Illuminated -25°C to +70°C Non-illuminated -25°C to +85°C	Connections	Plug-in solder terminals: 2.8mm x 0.5mm fast-on connector. Flying lead flat ribbon cable: 6 x 1.8mm flexible flat ribbon cable, length 300mm.
Switching elements	1NC; 2NC; 1NC + 1NO; forced-opening contacts	Standards	EN 60947-1, EN 60947-5-1, EN 60947-5-5, EN 418, DIN EN 60204-1
Gold-plated silver contacts	Switch ratings conforming to EN 60947-5-1 Rated operating current I_{θ} : AC 15 B300: 3A/120V; 1.5A/240V; $I_{th} = 5A$ DC 13 R300: 0.22A/120V; 0.1A/240V; $I_{th} = 2.5A$ Rated peak voltage: 2.5KV Rated insulation voltage U_i : 250VAC/DC Degree of pollution: 3 Rated Current: approx. 0.01 - 100mA AC/DC Rated voltage 1 - 42VAC/DC	Approvals	ENEC, UL, CE Pending

ORDERING INFORMATION

Other options are available, please contact your local sales office for further information.

Illuminated

Part Number	Plug-In Terminals	Ribbon Cable Termination	Illumination Colour	Colour of indication ring	1 normally-closed contact	1 normally-open contact	2 normally-closed contacts	Drawing references
84-5021.2B20	x				x			P10 / P20 / P30 / C10
84-5041.2B20	x					x		P10 / P20 / P30 / C10
84-5031.2B20	x				x	x		P10 / P20 / P30 / C10
84-5021.2B40		x			x			R10 / R20 / R30 / C10
84-5041.2B40		x				x		R10 / R20 / R30 / C10
84-5031.2B40		x			x	x		R10 / R20 / R30 / C10

Non Illuminated

Part Number	Plug-In Terminals	Ribbon Cable Termination	Colour of indication ring	1 normally-closed contact	1 normally-open contact	2 normally-closed contacts	Drawing references
84-5020.0020	x			x			P10 / P20 / P30 / C10
84-5040.0020		x			x		P10 / P20 / P30 / C10
84-5030.0020	x			x	x		P10 / P20 / P30 / C10
84-5020.0040		x		x			R10 / R20 / R30 / C10
84-5040.0040		x			x		R10 / R20 / R30 / C10
84-5030.0040		x		x	x		R10 / R20 / R30 / C10

A range of Emergency-stop accessories are available, please contact your local sales office for further information.

TECHNICAL DRAWINGS

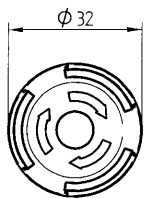

P10

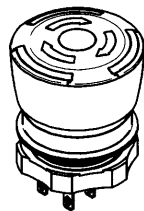

P20

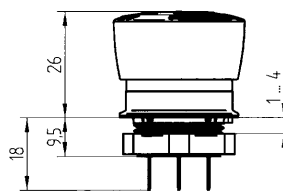

P30

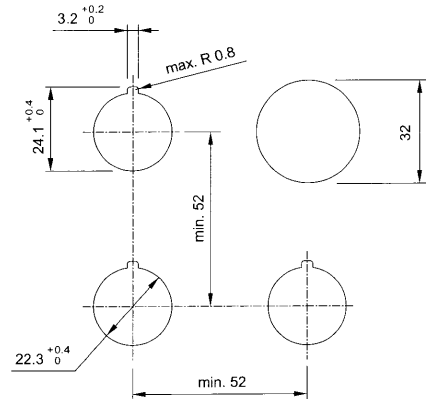

C10

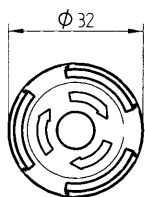

R10

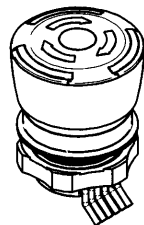

R20

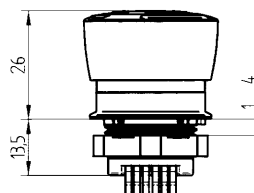

R30