

CUSTOMER _____ Y02 _____

Approval Sheet



DESIGNED NO.: SWITCHING POWER SUPPLIES

MODEL NO.: 3A-181WP09

ENG NO.: @3A-181WP09-028

APPROVAL		

- Remark: 1).Please approve and sign back to ENG ELEC.
 2).If there is no signing back,this Approval sheet will be regarded as being approved automaticly once the first P.O. of the model specified in the sheet is issued.

SUPPLIER		
DESIGN	CHECKED	APPROVED
		



英格爾科技股份有限公司
 ENG ELECTRIC CO., LTD.

台灣省桃園縣龜山鄉民生北路1段536號5樓
 5F,NO.536,Sec.1.Min Sheng N.Rd;Kweishan Hsiang,Taoyuan Hsien,Taiwan,R.O.C.
 TEL: 886-3-2121133, 886-3-212199
 FAX: 886-3-2121561

深圳英格爾電子有限公司
 SHENZHEN ENG ELECTRONICS CO., LTD.

深圳市寶安區福永鎮白石廈中核集團B棟
 Block B, Nuclear Group Industrial District, Baishixia, Fuyong Town, Bao'an, Shen Zhen China
 TEL: 86-755-27307512,27307515,27308750,27308755,27307208,27308202
 FAX: 86-755-27308049

SHENZHEN ENG ELECTRONICS CO., LTD.

FILE NO.: EN-RDS-6245

FILE: @3A-181WP09-028

產品承認書

SHEET: 01

1 Product Characteristics:

1.1 General Description

Model 3A-181WP09 is a universal switching-mode power supply, operating at input voltage 90VAC to 255VAC and output voltage of 9VDC with 2A DC load

1.2 Electric Characteristics

1.2.1 Input

No	ITEM	SPECIFICATION
1.	Rated input Voltage	AC100V-240V
	Vibration input Voltage Range	AC90V-255V
2.	Frequency Rated	50-60Hz
	Frequency Vibration	47-63Hz
3.	Input Rated Current	600mA RMS Max
	Inrush Current	30A Max .at 115vac cool start
		60A Max. at 230vac cool start
4.	Leakage current	0.25mA
5.	Efficiency	60% Min.

SHENZHEN ENG ELECTRONICS CO., LTD.

FILE NO.: EN-RDS-6245

FILE: @3A-181WP09-028

產品承認書 SHEET: 02

1.2.2 Output:

No	ITEM	V1
1.	output Voltage	9VDC
2.	output max. current	2A
3.	output min. Current	0A
4.	Line regulation	$\pm 1\%$
5.	Load regulation	$\pm 5\%$
6.	Over voltage protection	11.4V to 12.6V DC(output shut down)
7.	Short circuit protection	Output shut down and auto restart
8.	Ripple Voltage (L.F.)	150mV (p-p) (100V-240VAC Input)

1.2.3 HI-POT SPECIFICATION

Input to output : 3000VAC or 4242VDC 10mA 1 minute.

1.2.4 Insulation resistance:

Input to output: 500vdc to test the input to output resistance not be less 100M ohm

1.2.5 Safety approve: TUV CE UL CUL

1.2.6 EMI standard : meet FCC class B , CE ,VCCI - II

1.2.7 PB-free standard: (ENG-EHSM-M 009)

SHENZHEN ENG ELECTRONICS CO., LTD.

FILE NO.: EN-RDS-6245

FILE: @3A-181WP09-028

產品承認書 SHEET: 03

1.3 Mechanical Characteristics

1.3.1 AC Plug :

1.3.2 DC cord:

(1) Bending test: Life 1000 times 100% guarantee. Swings 120 from

Left to right loading weight 500g , 40 cycle/minute.

(2) Pull test : DC cord and plug ,weight 6kg for 1 minute.

1.3.3 Cord length and output plug: See Reference Att.4

1.3.4 Weight : _____ g

1.3.5 Case Size: (L)74 X (W) 43.5X (H) 34mm

1.3.6 Normal operating temperature and humidity

1.3.7 Temperature

Operating: 0℃ to 40℃

Storage : -10℃ to 70℃

1.3.8 Humidity

Operating : 20% to 80%.

Storage: 10% to 90%

SHENZHEN ENG ELECTRONICS CO., LTD.

FILE NO.: EN-RDS-6245 FILE: @3A-181WP09-028 產品承認書 SHEET: 04

2.Attachment:

- (Att.1) Label**
- (Att.2) Outdrawing**
- (Att.3) Package**
- (Att.3.1) Package flow chart**
- (Att.4) Dc cord drawing**
- (Att.5) Material list**
- (Att.6) Electrical test report**

Att.1

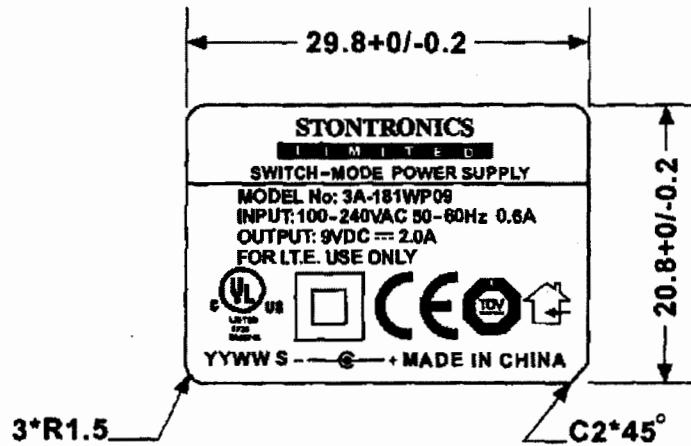

UNIT: mm

YYWW S YY:YEAR WW:WEEK S:FU YONG

ALUMINUM NAMEPLATE: ○ BLACK WORD ON SILVER BASE

○ SILVER WORD ON BLACK BASE

METALIZED POLYESTER: ● BLACK WORD ON SILVER BASE

(SILVER MATTE)

○ SILVER WORD ON BLACK BASE

TOLERANCE				

@3A-181WP09-028

DESIGNED	CHECKED	APPROVED	TITLE		DATE
Lipfu			LABEL		05/01/21
			UNITS	mm	DRAWING No.
			SCALE	2:1	N0Y02-0068
ENG ELECTRICS CO., LTD.			DRAWING NAME		REVISION
			1007		01

Att.2

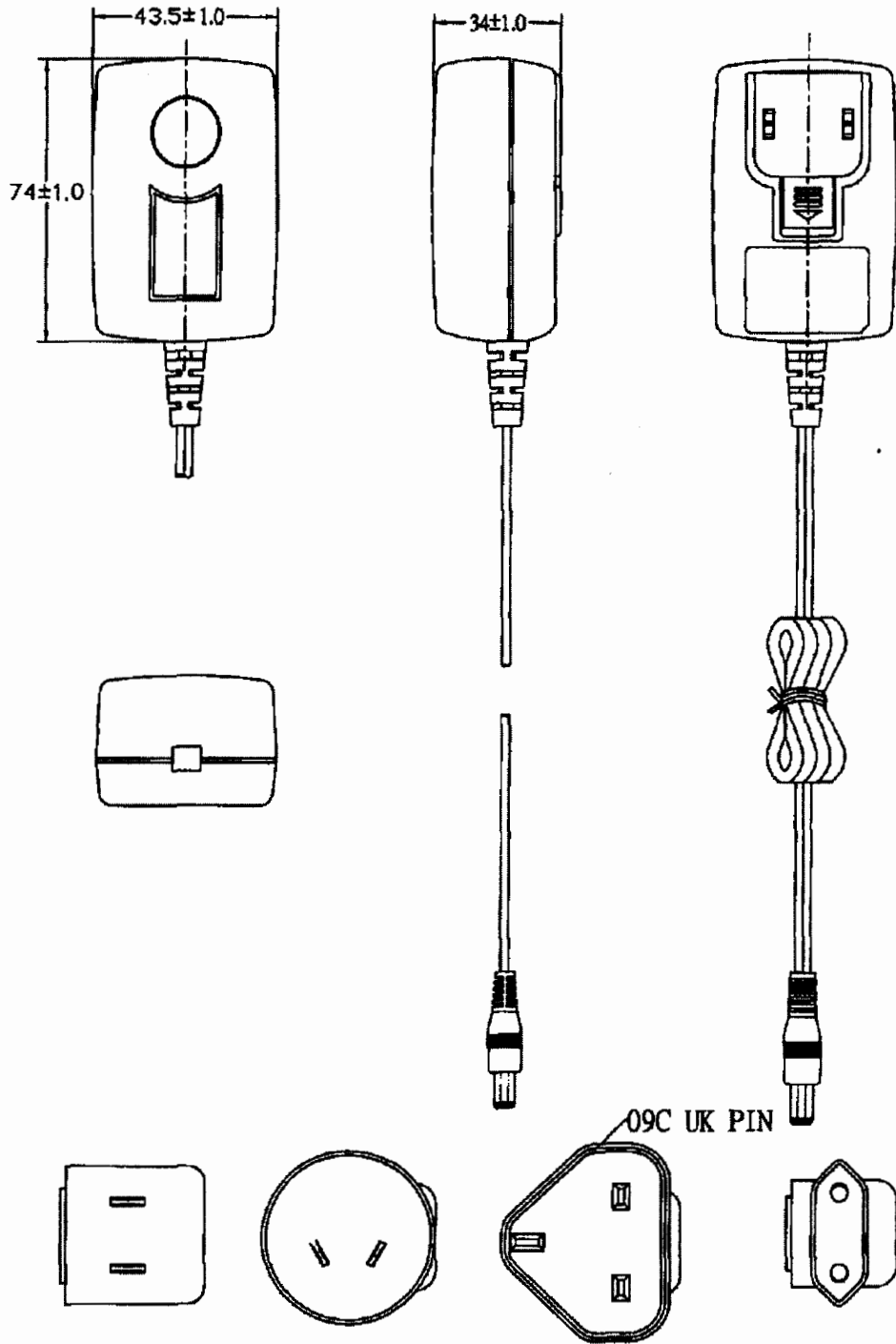

TOLERANCE			

DESIGNED	CHECKED	APPROVED		TITLE	DATE
<i>Lipp</i>				UNITS	OUTDRAWING
ENG ELECTRIC CO; LTD			mm	DRAWING No.	REVISION
			SCALE	@3A-181WP09-028	01
				DRAWING NAME	
				100721	

Att.3

CARTON SIZE: 478X421X200mm

外箱尺寸 478X421X200mm

Q'TY: 60pcs(20x3)

数量 60pcs(20x3)

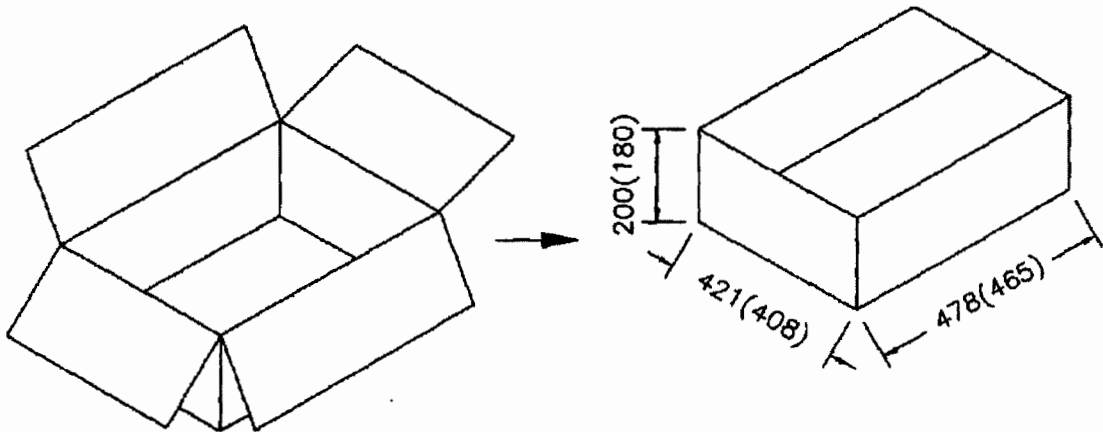
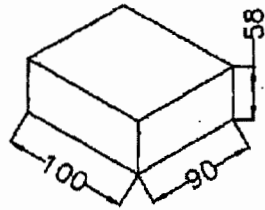

The tolerance of the internal dimensions of the carton is +7/-0

纸箱内度尺寸公差为+7/-0

TOLERANCE				

DESIGNED	CHECKED	APPROVED		TITLE	DATE
Lipp				PACKAGE	05/01/21
			UNITS	DRAWING No.	
			SCALE	P13-2030-H-50	
ENG ELECTRIC CO; LTD				DRAWING NAME	REVISION
				13-2030-H-50	01

Att.3.1

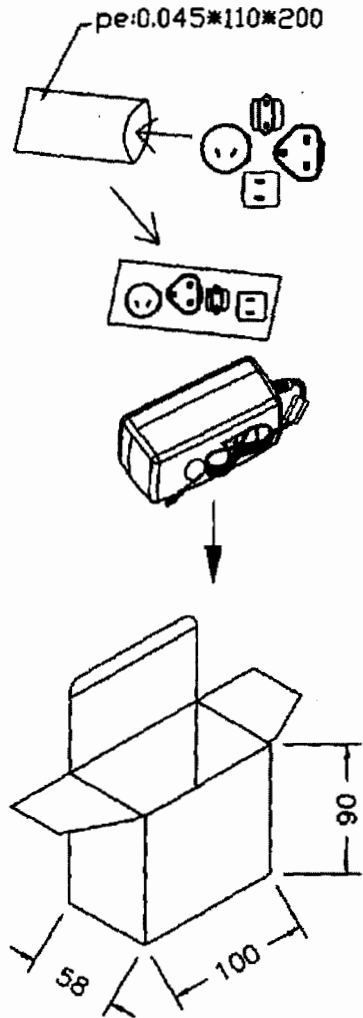

White Box: NO.13

小礼盒号码 13#

The tolerance of the external dimensions of the white box is ± 1
 小礼盒外度尺寸公差为 ± 1

TOLERANCE				

DESIGNED	CHECKED	APPROVED	TITLE		DATE
<i>Lipp</i>			PACKAGE FLOW CHART		
			UNITS	mm	DRAWING No.
			SCALE		@3A-181WP09-028
ENG ELECTRIC CO; LTD			DRAWING NAME		REVISION
			13#		01

Att.4

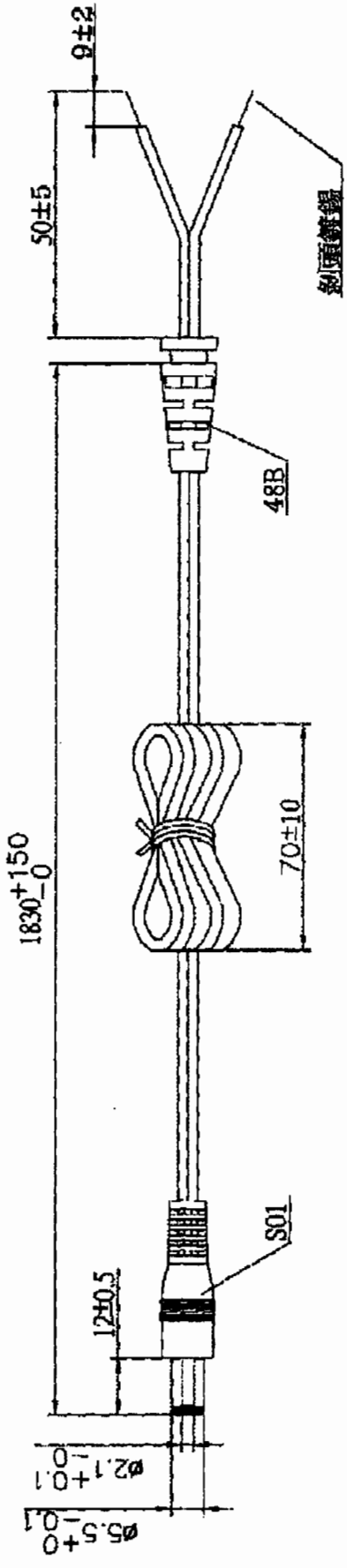

#20AWG X2C UL2468 有字接外, 無字接內

線材OD: Ø1.9*3.8

TOLERANCE

制作參數要求	
搖擺測試 VIBRATION TEST	a. 160° b. 吊重 200g WEIGHT 200g c. 40 回/分 40 ROUND/MINUTE d. 1000 次/最少 OVER 1000 COUNT MIN

DESIGNED	CHECKED	APPROVED	TITLE	DATE
2494	王國輝 藍天	研發部 藍天	DC CORD	05/01/21
ENG ELECTRIC CO; LTD			DRAWING No.	REVISION
			@3A-181WP09-028	01
			DRAWING NAME	
			31-48BS01-03B-00	