

XAC

pendant control stations

Catalogue 4.1980

177-629 /30/31

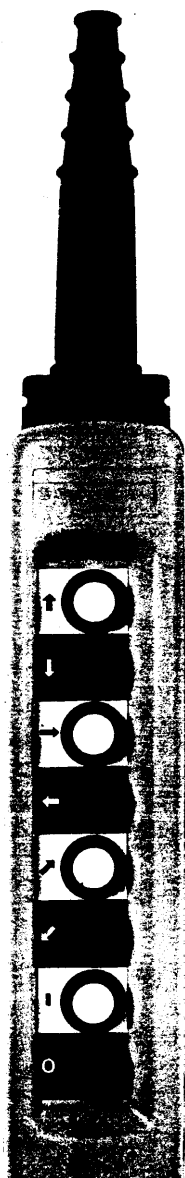

Dust and damp protected pendant stations

For control circuits

Complete stations

2 ways
"Small hoist"



2 to 8 ways
"General purpose"



Variable composition stations

2 to 12 ways
"General purpose"
Assembled by Telemecanique



For assembly by the customer



For power circuits

Complete stations

2 ways
"Small hoist"



2 to 6 ways
"General purpose"



Environment

Conformity to standards	IEC 337-1, NF C 63-140, VDE 0660 part 2
Approvals	XAC-A201 and A205 (Small hoist): CSA, UL, Nemko: pending XAC-A●●● (General purpose): ASE: pending
Protective treatment	TH finish
Ambient temperature	Storage: - 40° to + 70 °C. Operation: - 25° to + 70 °C.
Enclosures	XAC-A201 and A205 (Small hoist): Double insulated polyamide enclosure coloured yellow throughout XAC-A●●● (General purpose): Double insulated polypropylene enclosure coloured yellow throughout
Operating position	All positions
Vibration resistance	15 g (from 40 to 500 Hz) in accordance with IEC 68-2-6
Shock resistance	100 g in accordance with IEC 68-2-27
Electric shock protection	Class II conforming to IEC 536 and NF C 20-030
Degree of protection	IP 65 in accordance with IEC 529
Mechanical life	1 million operations

Contact block characteristics

Rated thermal current	10 A in accordance with IEC 337-1, NF C 63-140, VDE 0660 part 2 and CSA C22-2 No. 14
Rated insulation voltage	ZB2-BE and XEN-G : 500 V AC and DC in accordance with IEC 158-1, NF C 20-040 and VDE 0110
Insulation category	Group C in accordance with NF C 20-040 and VDE 0110
Contact operation	Slow break with positive opening action
Contact resistance (across terminals)	ZB2-BE and XEN-G : < 25 m Ω
Operating force	XAC-A201 : 1.3 daN and XAC-A205 : 1.5 daN XAC-A●●● (General purpose) with contact blocks ZB2-BE: 1 daN (N/O) and 1.3 daN (C/O) with contact blocks XEN-G1491: 1.4 daN (1 N/C + 2 N/O) with contact blocks XEN-G1191: 1.4 daN (1st step) 2.5 daN (2nd step)
Terminal referencing	In accordance with CENELEC EN 50013
Short circuit protection	10 A cartridge fuse type gI or N, in accordance with IEC 337-1B and VDE 0660 part 2

Breaking capacities	ZB2-BE and XEN-G	Alternating current (50-60 Hz)	Direct current
----------------------------	-------------------------	---------------------------------------	-----------------------

Complete pendant stations for control circuits

XAC-A

"Small hoist" type (contact block operators form an integral part of the enclosure)



XAC-A20 •

Number of ways	Functions	Contact blocks, per pushbutton, ready-mounted	Scheme for each way	Reference	Weight kg
2 Mechanically interlocked	↑ ↓	1 N/O		XAC-A201	0.280
		1 N/C + 1 N/O		XAC-A205	0.310

General purpose (with interchangeable, booted, pushbuttons)



2	↑ ↓	1 N/O		XAC-A271	0.475
		1 N/C + 1 N/O		XAC-A281	0.500

XAC-A4 ••



6	↑ ↓ → ←	1 N/C + 1 N/O		XAC-A481	0.675
---	------------------	---------------	--	-----------------	-------



6	↑ ↓ → ←	1 N/O		XAC-A671	0.800
		1 N/C + 1 N/O		XAC-A681	0.880

Components for pendant stations for control circuits

Empty enclosures
Legend plates with or without text

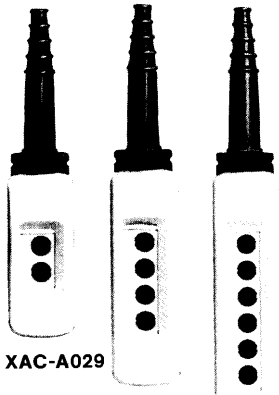

XAC-A029

XAC-A049

XAC-A069

Empty enclosures (for assembly by Telemecanique)

Type	Cable sleeve	Number of ways	Reference	Weight kg
Double insulated	For cable Ø 8 to 26 mm	2	XAC-A029	0.440
		4	XAC-A049	0.540
		6	XAC-A069	0.665
		8	XAC-A089	0.770
		12	XAC-A129	1.000

The above references include:

- The internal mounting plate
- The cable sleeve for cable Ø 8 to 26 mm
- The internal cable clamp
- The suspension ring
- The cable tie (to tighten sleeve onto cable)
- The assembly of the contact blocks and pushbuttons

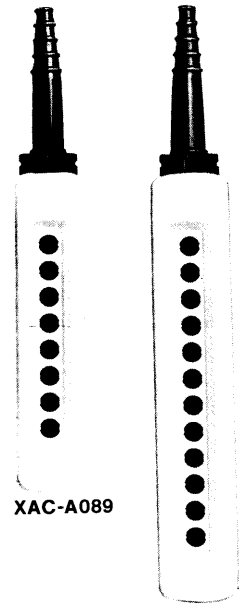

XAC-A089

XAC-A129

Attachments

Type		Reference	Weight kg
Adaptors for self-supporting cable type BBAP	Adapts to collar fitted with Ø 8 to 26 mm cable sleeve	XAC-B961	0.025
Lower support ring		XAC-A971	0.010

Protective guards

Mounted in the base of the enclosure	For selector switch or mushroom head pushbutton Ø 40 mm	XAC-A982	0.025
	For key switch	XAC-A983	0.045

Standard legend plates (30 x 40 mm)

Text	Reference	Weight kg	Text	Reference	Weight kg
Start functions: white letters, black background. Stop functions: white letters, red background					

Black legend plates

Black-white-red	ZB2-BY2101	0.001	White-black-yellow	ZB2-BY4101	0.001
-----------------	-------------------	-------	--------------------	-------------------	-------

Legend plates with English texts

For pushbuttons

Start	ZB2-BY2303	0.001	Left	ZB2-BY2310	0.001
Stop	ZB2-BY2304	0.001	On	ZB2-BY2311	0.001
Forward	ZB2-BY2305	0.001	Off	ZB2-BY2312	0.001
Reverse	ZB2-BY2306	0.001	Reset	ZB2-BY2323	0.001
Up	ZB2-BY2307	0.001	Power on	ZB2-BY2326	0.001
Down	ZB2-BY2308	0.001	Slow	ZB2-BY2327	0.001
Right	ZB2-BY2309	0.001	Fast	ZB2-BY2328	0.001

For selector switches

O-I	ZB2-BY2178	0.001	I-O-II	ZB2-BY2186	0.001
-----	-------------------	-------	--------	-------------------	-------

Non-standard texts

2 lines maximum with 11 characters per line

Black background	ZB2-BY2002	0.001	White background	ZB2-BY4001	0.001
Red background	ZB2-BY2004	0.001	Yellow background	ZB2-BY4005	0.001

♦ Also available

Legend plates with other texts

Please consult your local sales office

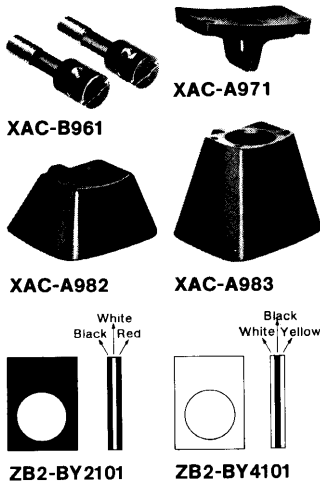

ZB2-BY2101

ZB2-BY4101

When ordering



a complete station, assembled by Telemecanique, see page 9
an enclosure for assembly by the customer, see page 10
a legend plate with non-standard text
Please state the exact reference and the text to be engraved.
Example: ZB2-BY4001 "Pump 1"

Components for pendant stations for control circuits

XAC-A

Legend plates with standard symbols

Legends 30 x 40 mm

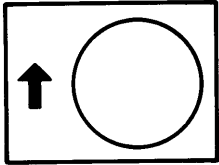

Black symbol, white background

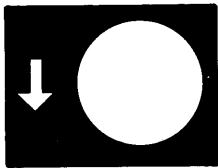

White symbol, black background

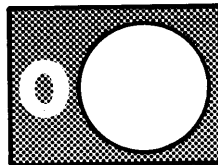

White symbol, red background

Function	Black symbol White background	Reference	Weight kg	Function	White symbol Black background	Reference	Weight kg
Raise Slow		ZB2-BY4901	0.001	Lower Slow		ZB2-BY2904	0.001
Raise Fast		ZB2-BY4902	0.001	Lower Fast		ZB2-BY2905	0.001
Raise Slow-Fast		ZB2-BY4903	0.001	Lower Slow-Fast		ZB2-BY2906	0.001
Right Slow		ZB2-BY4907	0.001	Left Slow		ZB2-BY2910	0.001
Right Fast		ZB2-BY4908	0.001	Left Fast		ZB2-BY2911	0.001
Right Slow-Fast		ZB2-BY4909	0.001	Left Slow-Fast		ZB2-BY2912	0.001
Forward Slow		ZB2-BY4913	0.001	Reverse Slow		ZB2-BY2916	0.001
Forward Fast		ZB2-BY4914	0.001	Reverse Fast		ZB2-BY2917	0.001
Forward Slow-Fast		ZB2-BY4915	0.001	Reverse Slow-Fast		ZB2-BY2918	0.001
Slew Right Slow		ZB2-BY4919	0.001	Slew Left Slow		ZB2-BY2922	0.001
Slew Right Fast		ZB2-BY4920	0.001	Slew Left Fast		ZB2-BY2923	0.001
Slew Right Slow-Fast		ZB2-BY4921	0.001	Slew Left Slow-Fast		ZB2-BY2924	0.001
Slow		ZB2-BY4933	0.001	Fast		ZB2-BY4934	0.001
Klaxon		ZB2-BY4932	0.001	Klaxon on		ZB2-BY4935	0.001
Start		ZB2-BY4930	0.001	Stop		ZB2-BY2931*	0.001

* White symbol, red background

When ordering



a complete station assembled by Telemecanique, see page 9
a legend plate with symbol
Please state the exact reference
Example: ZB2-BY4901

Contact blocks

For front mounting



ZB2-BE10 •

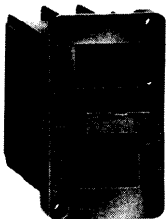

XEN-G1 • 91

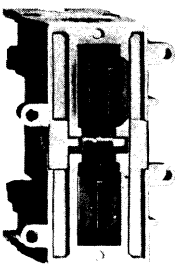

XEN-G37 •1

Type	Function	Scheme	Reference	Weight kg
Normal spring return	1N/O		ZB2-BE101	0.015
	1N/C		ZB2-BE102	0.015
	1N/O + 1N/C + 1N/O staggered		XEN-G1191	0.040
	1N/O + 1N/C + 1N/O simultaneous		XEN-G1491	0.040
Latching (double block)	1N/O		XEN-G3781	0.060
	1N/O			
	1N/O		XEN-G3791	0.060
	1N/C			

For base mounting

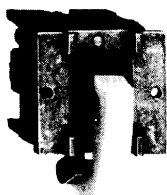

XAC-S10 •

Normal spring return	1N/O		XAC-S101	0.030
	1N/C		XAC-S102	0.030
	2N/O		XAC-S103	0.045
	2N/C		XAC-S104	0.045
	1N/C + 1N/O		XAC-S105	0.045

When ordering



a complete station assembled by Telemecanique, see page 9
a contact block.
Please state the exact reference.
Example: ZB2-BE101

Components for pendant stations for control circuits

Operators



XAC-A94 ●●



ZA2-BC4



ZA2-BS54

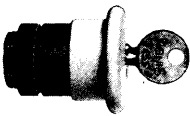

ZA2-BS14



ZA2-BD ●

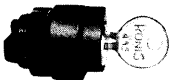

ZA2-BG ●



ZA2-BB ●

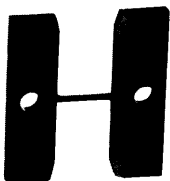

XAC-A009



ZB2-SZ3

For front mounting



Sold in quantities of 10

Type	Insert colour	Unit reference	Weight kg
Complete booted pushbutton operator	White	XAC-A9411	0.010
	Black	XAC-A9412	0.010
	Green	XAC-A9413	0.010
	Red	XAC-A9414	0.010
	Yellow	XAC-A9415	0.010
	Blue	XAC-A9416	0.010
	Brown	XAC-A9419	0.010

For front or base mounting

Type		Reference	Weight kg
Red Mushroom head pushbutton Ø 40 mm	Normal spring return	ZA2-BC4	0.032
	Latching "Turn to release"	ZA2-BS54	0.032
	With key No. 455 Locks in the "in" position Key withdrawal in the "out" position after resetting	ZA2-BS14	0.064
Selector switch (Not to be used in conjunction with contact blocks XEN-G)	With black operator	2 positions stay-put ZA2-BD2	0.020
		3 positions stay-put ZA2-BD3	0.020
	With key No. 455 Key withdrawal from the right and left position	2 positions stay-put ZA2-BG4	0.047
	3 positions stay-put ZA2-BG5	0.047	
Wobble stick (base mounting recommended)	Operating in any direction "Fast stop" function	Black ZA2-BB2	0.060
		Red ZA2-BB4	0.060

Mechanical interlock

Between 2 buttons (See page 9 for possible combinations)	XAC-A009	0.003
---	----------	-------

Blanking plug

Complete with seal and fixing nut	ZB2-SZ3	0.005
--	---------	-------

When ordering



a complete station assembled by Telemecanique, see page 9
an operating head.
Please state the exact reference.
Example: XAC-A9411.

Pilot lights



Pilot light bodies for front mounting

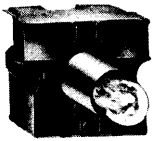

ZB2-BV006



ZB2-BV007

Supply	Scheme	Control circuit voltage	Reference	Weight kg
Direct Bulb not supplied ★	X1  X2	≤ 130 V	ZB2-BV006	0.015
Direct supply with voltage reduction BA9s, 130 V bulb supplied	 X1  X2	220/250 V	ZB2-BV007	0.020

★ Bulb type for direct supply: BA9s. Incandescent bulb U ≤ 130 V. Max. power: 2.6 W.
See page 10

Heads for pilot light bodies



ZA2-BV0 •

Type	Colour	Reference	Weight kg
Lens cap with fixing collar for incandescent bulbs	Green	ZA2-BV03	0.010
	Red	ZA2-BV04	0.010
	Yellow	ZA2-BV05	0.010
	Blue	ZA2-BV06	0.010
	Clear	ZA2-BV07	0.010

♦ **Also available**

- Numerical display units with 3 digits, suitable for 6, 8 or 12-way stations.
- Lens cap with fixing collar for neon bulbs.
Please consult your local sales office.

When ordering



a complete station assembled by Telemecanique, see page 9 a pilot light body or lens assembly.
Please state the exact reference.
Example: ZB2-BV006.

Dust and damp protected pendant stations XAC-A

Order form

Variable composition stations for control circuits assembled by Telemecanique

Use a photocopier to reproduce this page or ask for separate order form. ref: CF 450GB

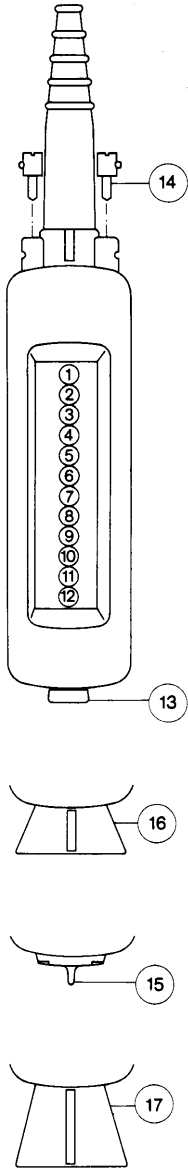
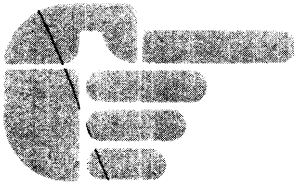

★ Mechanical interlock

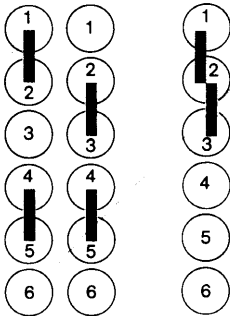

Possible combinations

Impossible combinations

TO BE COMPLETED BY TELEMECANIQUE

Name	Branch/Sales office
Date	Order No.
	Delivery date

TO BE COMPLETED BY THE CUSTOMER

Firm	Sheet No.
Date	Customers order No.
	Delivery date

Number of identical units required	Unit reference of enclosure				Price
	XAC-A <input type="checkbox"/> <input type="checkbox"/> <input type="checkbox"/>				
Functions (optional)	Mechanical interlock (draw a line between the 2 units to be interlocked★)	Legends	Contact blocks and pilot light bodies	Pushbutton, pilot light or blanking plug	Price
	①				
	②				
	③				
	④				
	⑤				
	⑥				
	⑦				
	⑧				
	⑨				
	⑩				
	⑪				
	⑫				

Mechanical interlock XAC-A009 Number of XAC-A009 required X unit price =

Unit mounted in base of station (facing downwards)

⑬				
---	--	--	--	--

Price of the station without attachments

Attachments

	Position	Type	Reference	X
Cross the appropriate box if required	⑭	Adaptors for self-supporting cable type BBAP (only available with Ø 8 to Ø 26 mm cable sleeve)	XAC-B961	
	⑮	Lower support ring	XAC-A971	
	⑯	Protective guard for base mounted selector switch or Ø 40 mm emergency stop pushbutton	XAC-A982	
	⑰	Protective guard for key switch	XAC-A983	

Total price of the station



CF450GB

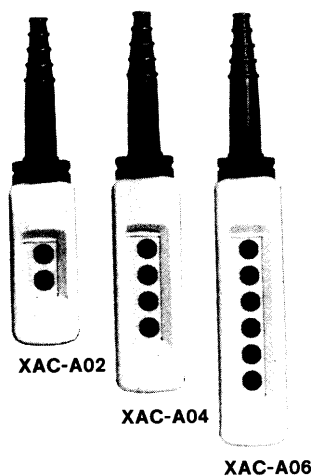

Empty enclosures (for assembly by the customer)

Type	Cable sleeve	Number of ways	Reference	Weight kg
Double insulated block fixing centres: 30 mm	For cable Ø 8 to 26 mm	2	XAC-A02	0.440
		4	XAC-A04	0.540
		6	XAC-A06	0.665
		8	XAC-A08	0.770
		12	XAC-A12	1.000

The above references include:

The internal mounting plate
The cable sleeve for cable Ø 8 to 26 mm
The internal cable clamp
The suspension ring
The cable tie (to tighten sleeve onto cable)

Legends (see pages 4 and 5)

Contact blocks (see page 6)

Operators (see page 7)

Pilot lights (see page 8)

Incandescent bulbs

 Sold in quantities of 10

BA9s base fitting. Max. Ø: 11 mm. Max. length: 28 mm

Voltage	Maximum power	Unit reference	Weight kg
6 V	1.5 W	DL1-CB006	0.002
12 V	2.6 W	DL1-CE012	0.002
24 V	2.6 W	DL1-CE024	0.002
48 V	2.6 W	DL1-CE048	0.002
130 V	2.6 W	DL1-CE130	0.002

Tool (sold singly)

Type	Reference	Weight kg
Extractor	For bulb BA9s	XBF-X13
		0.025

Cable sleeve with cable tie

For stations XAC-A201 and A205	Ø 9 to 13 mm	XAC-A913	0.070
For stations XAC-A●●●	Ø 8 to 26 mm	XAC-A960	0.090

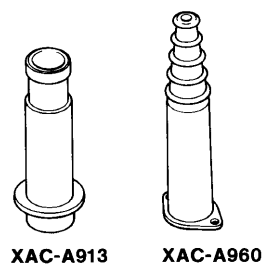
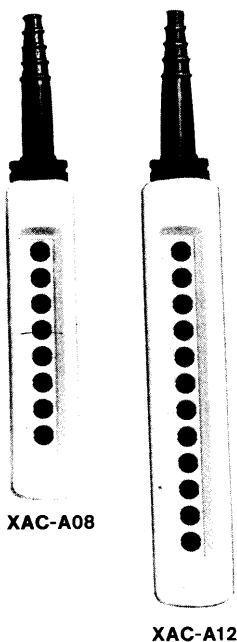

When ordering



an empty enclosure for assembly by the customer.
Please state the exact reference. Example: XAC-A02.
Should any other units be required, these should be added, and will be supplied separately.

Dimensions of pendant stations for control circuits

XAC-A

"Small hoist" type
XAC-A201 and A205

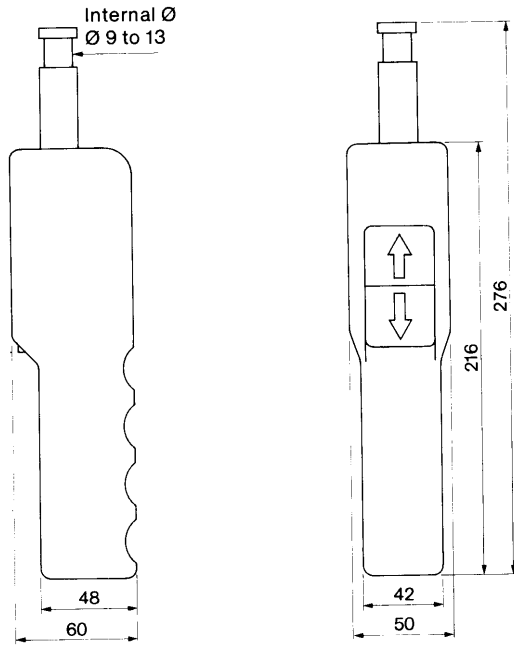

"General purpose" type
XAC-A●●●

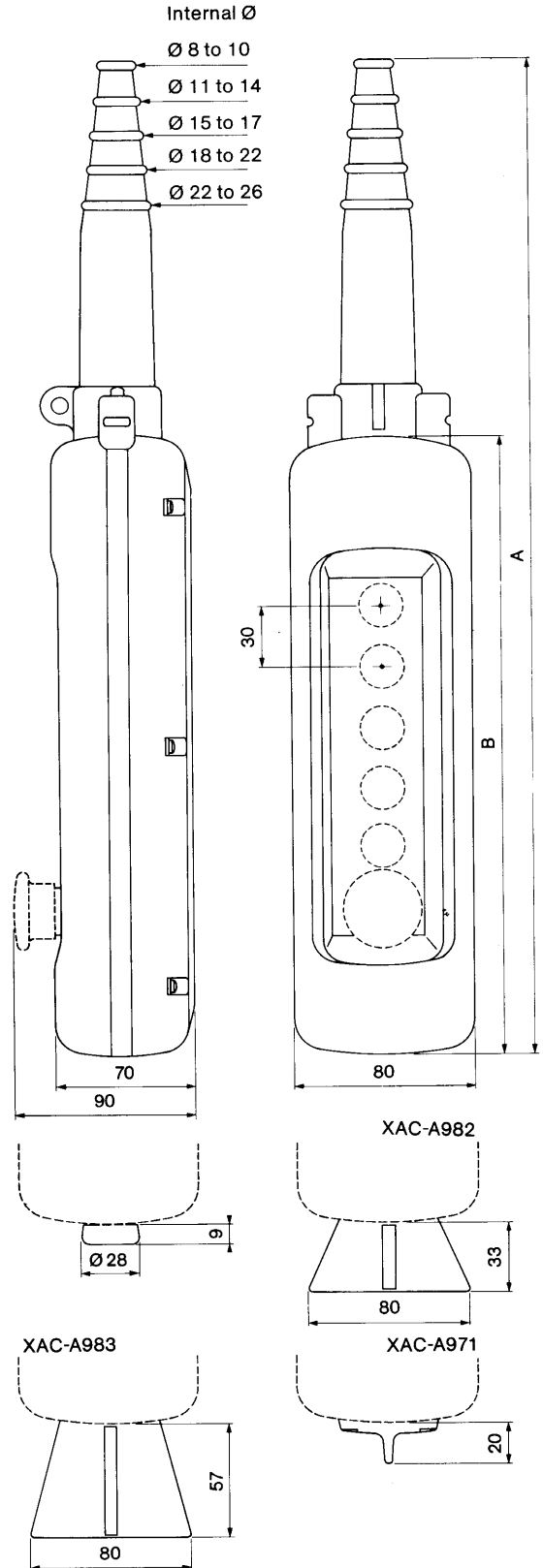

Number of ways	2	4	6	8	12 (1 row)
A	380	440	500	560	680
B	190	250	310	370	490

Environment

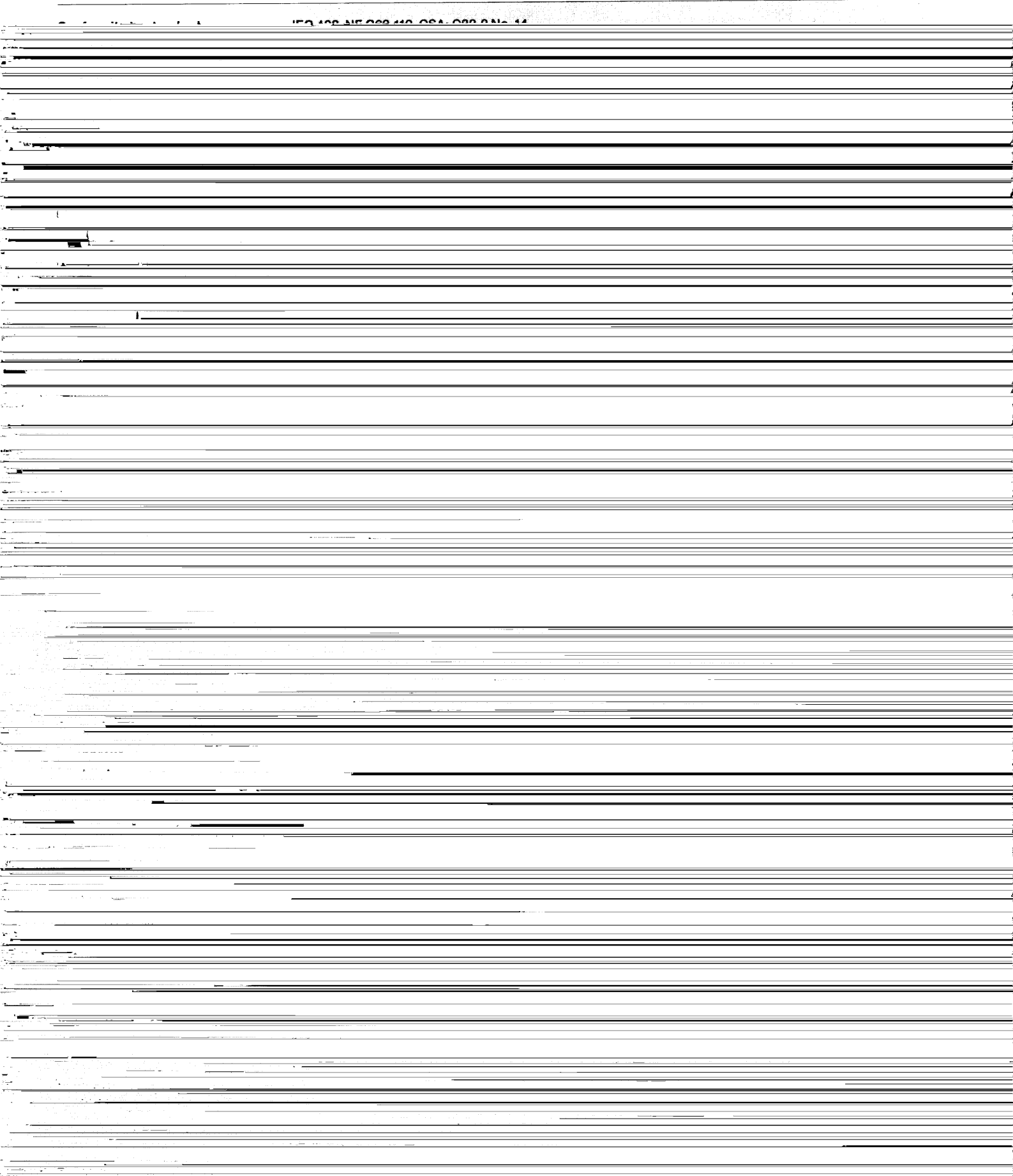

Complete pendant stations for power circuits

XAC-B

“Small hoist” type (for 1 speed reversing motors)



Number of ways	Functions	Maximum rated power	Scheme for each pair of ways	Reference	Weight kg
2 Mechanically interlocked	↑ ↓	2.2 kW 380 V		XAC-B219	0.800

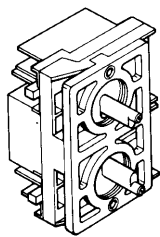

XES-D1191

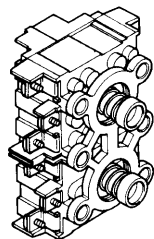

XES-D2201

Two pole contact block

Type	Maximum rated power	Scheme	Reference	Weight kg
Double unit 2 contacts blocks mechanically interlocked Fixing centres: 40 mm	2.2 kW 380 V		XES-D1191	0.140
Wiring diagrams see page 15				

Triple pole contact block

Type	Maximum rated power	Scheme	Reference	Weight kg
Double unit 2 contact blocks mechanically interlocked Fixing centres: 40 mm	3 kW 380 V		XES-D2201	0.200
Wiring diagrams see page 15				

Complete booted pushbutton operators

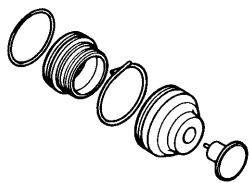

XAC-B9112

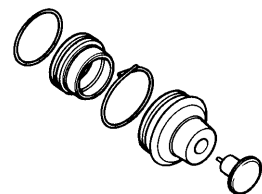

XAC-B9212

Type	Operating temperature limits	Insert colour	Unit reference	Weight kg
For contact blocks XES-D1191	- 25° to + 70 °C	White	XAC-B9211	0.005
		Black	XAC-B9212	0.005
		Green	XAC-B9213	0.005
		Red	XAC-B9214	0.005
		Yellow	XAC-B9215	0.005
		Blue	XAC-B9216	0.005
For contact blocks XES-D2201	- 25° to + 70 °C	Brown	XAC-B9219	0.005
		White	XAC-B9111	0.005
		Black	XAC-B9112	0.005
		Green	XAC-B9113	0.005
		Red	XAC-B9114	0.005
		Yellow	XAC-B9115	0.005
		Blue	XAC-B9116	0.005
		Brown	XAC-B9119	0.005

➔ Also available

- Two pole contact block (double unit).
2 step (the 2nd step operating 1C/0) for 2 speed motors with separate windings.
- Triple pole contact block (double unit).
With 2 simultaneous or staggered auxiliary contacts.
- Triple pole, positive acting, isolating contact block and operating head.

Dimensions and wiring diagrams for pendant stations for power circuits

XAC-B

Dimensions

"Small hoist" type
XAC-B219 and B220

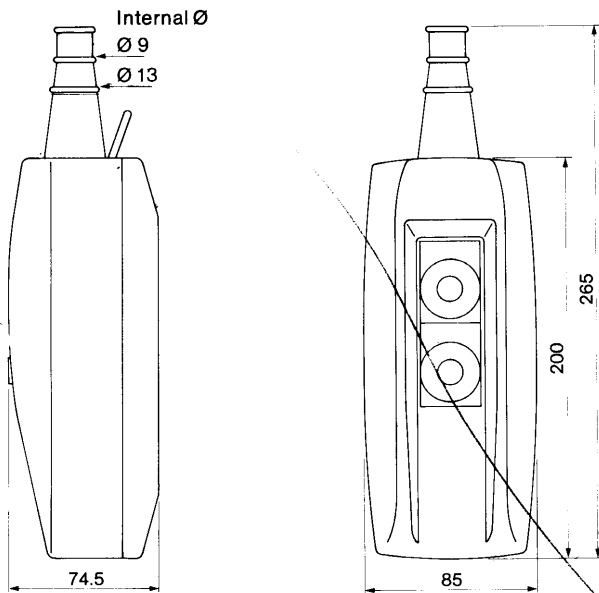

"General purpose"
XAC-B...

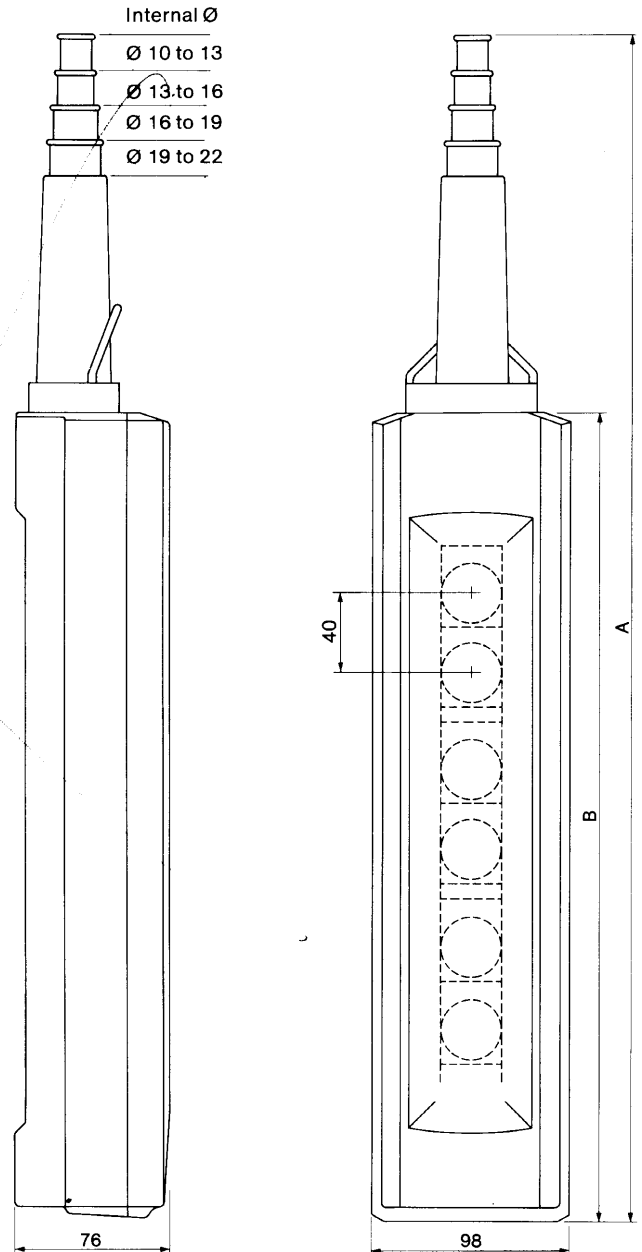

Wiring diagrams

For two pole contact block
XES-D1191
2-phase switching
(1-phase direct)

For triple pole contact block
XES-D2201
3-phase switching

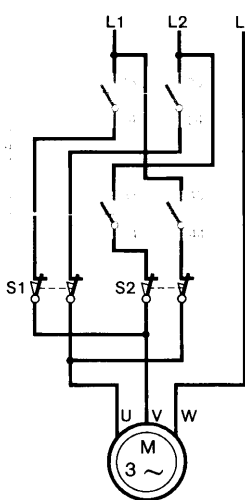

Single speed reversing motor

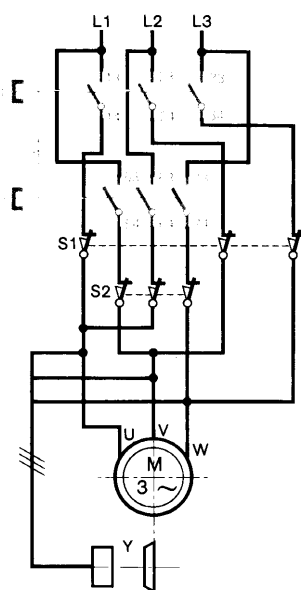

Single speed reversing motor

Number of ways	2	4	6
A	409	499	589
B	220	310	400