

ASMT-QYBC-Nxxxx

Super 0.5W Warm White Power PLCC-4
Surface Mount LED Indicator

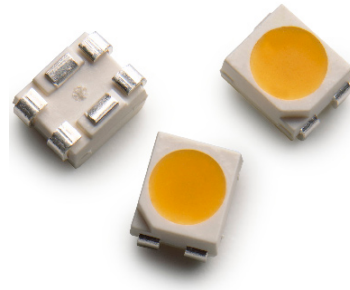

Data Sheet



Description

The Super 0.5W Warm White Power PLCC-4 SMT LED is Warm white mid-Power PLCC-4 SMT LEDs using InGaN chip technology. The package can be driven at high current due to its superior package design. The product is able to dissipate the heat more efficiently compared to the Power PLCC-4 SMT LEDs. These LEDs produce higher light output with better flux performance compared to the Power PLCC-4 SMT LED.

The Super 0.5W Warm White Power PLCC-4 SMT LEDs are designed for higher reliability, better performance, and operate under a wide range of environmental conditions. The performance characteristics of these new mid-power LEDs make them uniquely suitable for use in harsh conditions such as in automotive applications, and in electronics signs and signals.

To facilitate easy pick and place assembly, the LEDs are packed in EIA-compliant tape and reel. Every reel is shipped in single intensity and color bin, to provide close uniformity.

Features

- Industry Standard PLCC 4 platform (3.2x2.8x1.9mm)
- High reliability package with enhanced silicone resin encapsulation
- High brightness with optimum flux performance using InGaN chip technologies
- Available in Warm White
- Available in 8mm carrier tape & 7 inch reel
- Low Thermal Resistance 40°C/W
- Wide viewing angle at 120 degree
- JEDEC MSL 2

Applications

1. Interior automotive
 - a. Instrument panel backlighting
 - b. Central console backlighting
 - c. Navigation and audio system backlighting
 - d. Dome/Map lighting
 - e. Push button backlighting
 - f. Puddle lamp
 - g. Glove compartment illumination
2. Exterior automotive
 - a. Number plate illumination
3. Electronic signs and signals
 - a. Decorative lighting
4. Office automation, home appliances, industrial equipment
 - a. Panel/button backlighting
 - b. Display backlighting

CAUTION: ASMT-QWBC-Nxxxx LEDs are Class 2 ESD sensitive. Please observe appropriate precautions during handling and processing. Refer to Avago Application Note AN-1142 for additional details.

Package Drawing

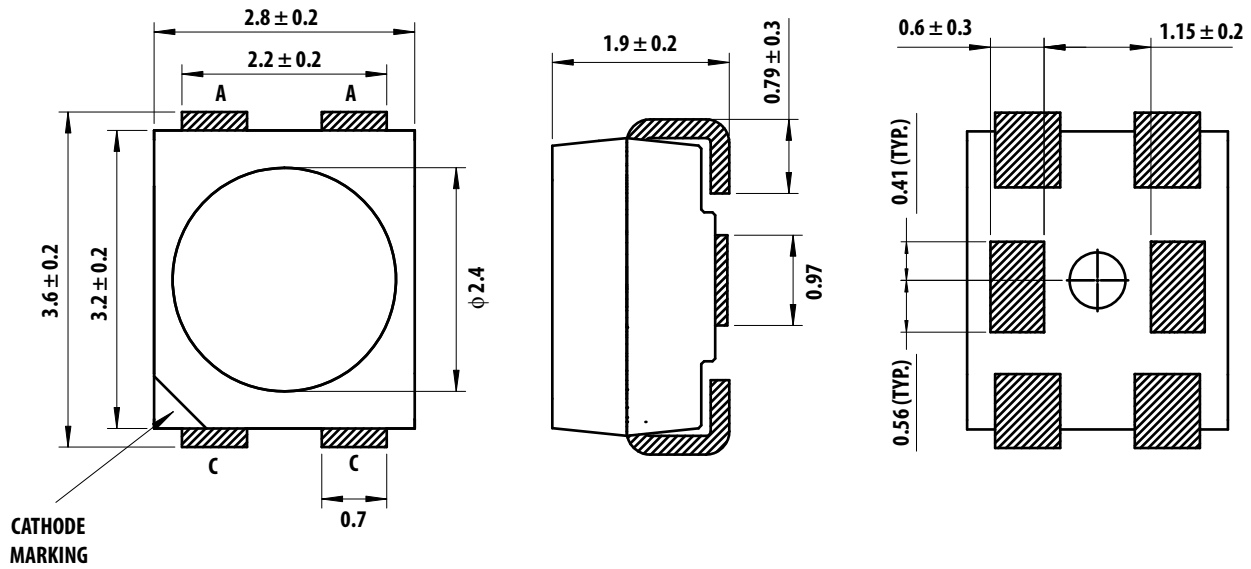

Notes:

1. All Dimensions in millimeters.
2. Lead Polarity as shown in Figure 13.
3. Terminal Finish: Ag plating
4. Encapsulation material: Silicone resin

Figure 1. Package Drawing

Table 1. Device Selection Guide ($T_j = 25^\circ\text{C}$)

Color	Part Number	Luminous Flux, $\Phi_V^{[1]}$ (lm)			Test Current (mA)	Dice Technology
		Min. Flux (lm)	Typ. Flux (lm)	Max. Flux (lm)		
Warm White	ASMT-QYBC-NGJ0E	19.5	24.0	43.0	150	InGaN

Notes:

1. Φ_V is the total luminous flux output as measured with an integrating sphere at mono pulse conditions.
2. Tolerance = $\pm 12\%$

Part Numbering System

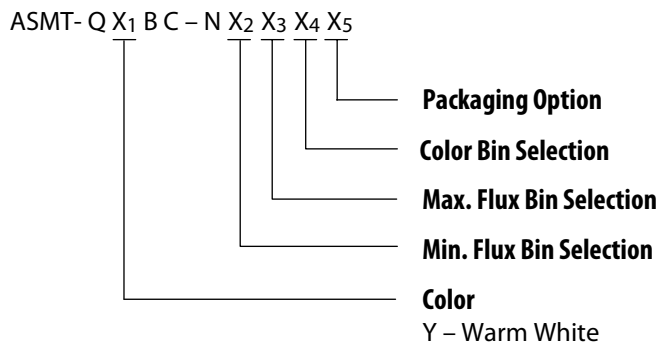

Table 2. Absolute Maximum Ratings ($T_A = 25^\circ\text{C}$)

Parameters	ASMT-QYBC-Nxxxx
DC Forward Current ^[1]	150 mA
Peak Forward Current ^[2]	300 mA
Power Dissipation	570 mW
Reverse Voltage, V_R @ 10 μA	4
Junction Temperature	125°C
Operating Temperature	-40°C to +120°C
Storage Temperature	-40°C to +120°C

Notes:

1. Derate Linearly as shown in Figure 6.
2. Duty Factor = 10%, Frequency = 1kHz

Table 3. Optical Characteristics ($T_J = 25^\circ\text{C}$)

Color	Part Number	Dice Technology	Typical Chromaticity Coordinates		Viewing Angle $2\theta_{1/2}$ ^[1] (Degrees)	Luminous Efficiency η_e (lm/W)	Total Flux / Luminous Intensity Φ_V (lm) / I_V (cd)
			x	y	Typ.	Typ.	Typ.
Warm White	ASMT-QYBC-Nxxxx	InGaN	0.40	0.39	120	47	2.30

Notes:

1. $\theta_{1/2}$ is the off-axis angle where the luminous intensity is $1/2$ the peak intensity.

Table 4. Electrical Characteristics ($T_J = 25^\circ\text{C}$)

Part Number	Forward Voltage V_F (Volts) @ $I_F = 150$ mA		Thermal Resistance $R\theta_{J,p}$ ($^\circ\text{C}/\text{W}$)
	Typ.	Max.	
ASMT-QYBB-NxxxE	3.4	3.8	40

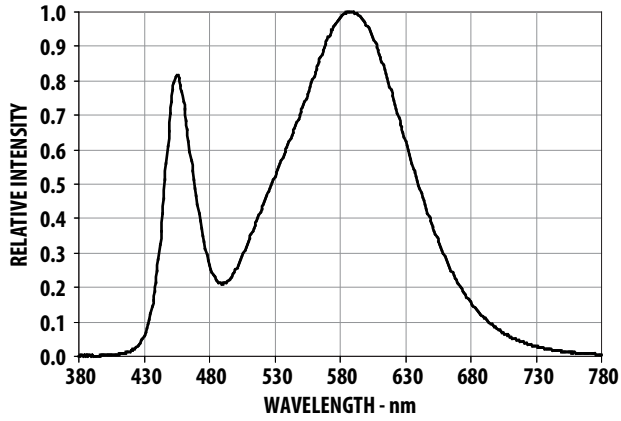

Figure 2. Relative Intensity Vs. Wavelength

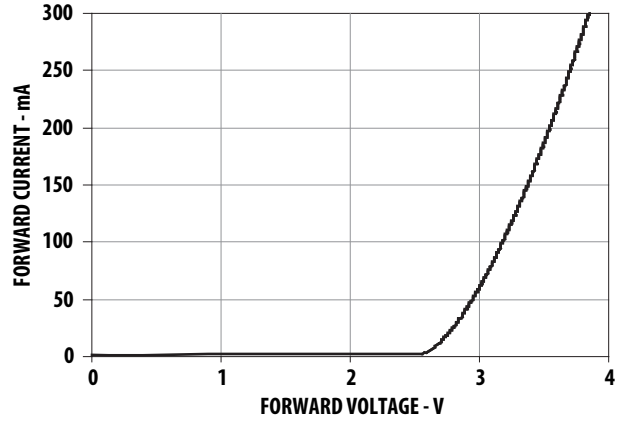

Figure 3. Forward Current Vs. Forward Voltage.

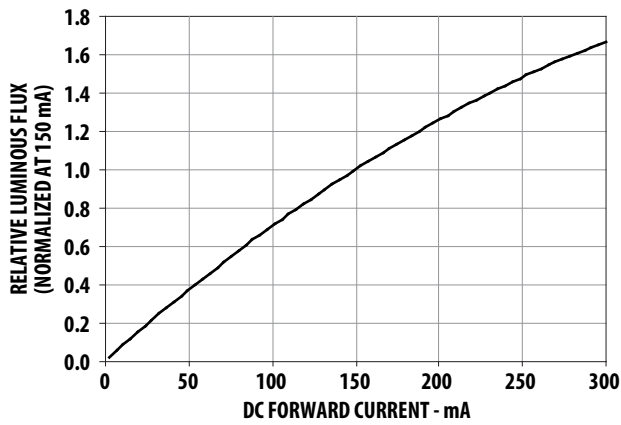

Figure 4. Relative Flux vs. Forward Current

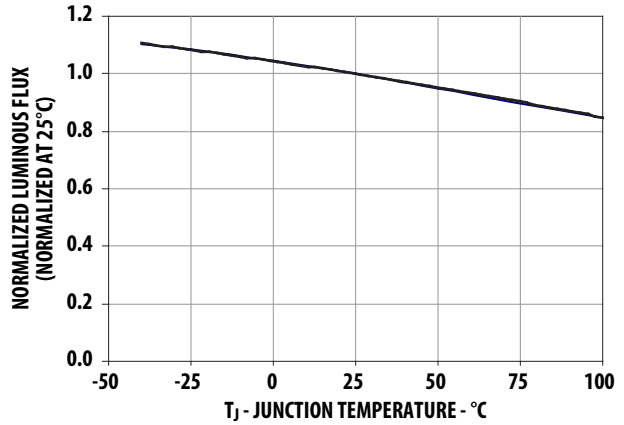

Figure 5. Relative Flux Vs. Temperature

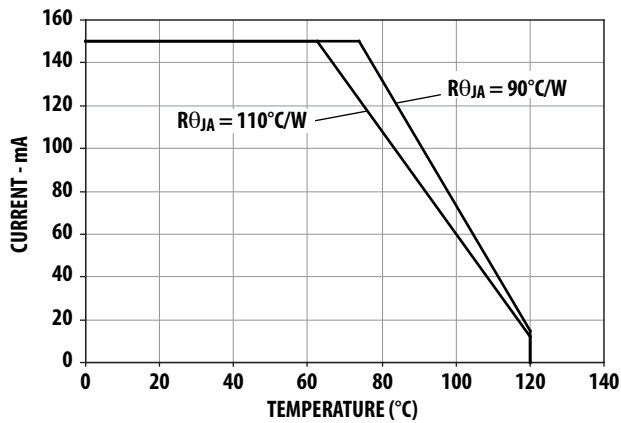

Figure 6a. Maximum Forward Current Vs. Ambient Temperature. Derated Based on $T_{JMAX} = 125^{\circ}C$, $R_{\theta JA} = 110^{\circ}C/W$ & $90^{\circ}C/W$.

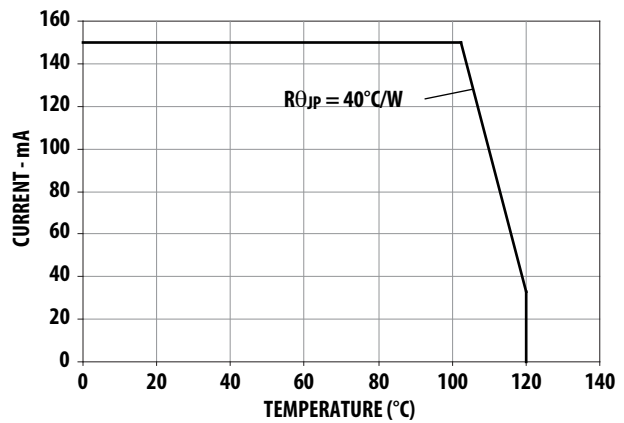

Figure 6b. Maximum Forward Current Vs. Solder Point Temperature. Derated Based on $T_{JMAX} = 125^{\circ}C$, $R_{\theta JP} = 40^{\circ}C/W$.

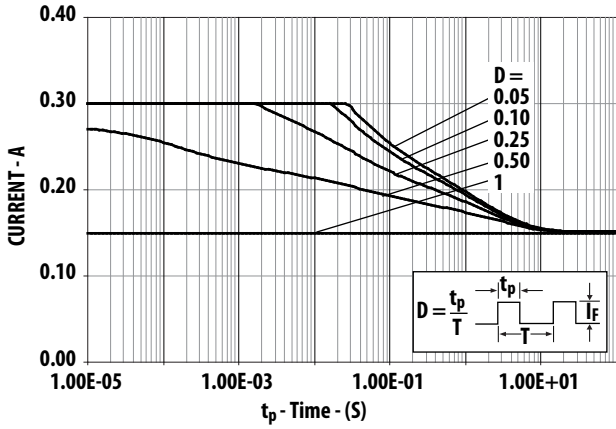

Figure 7a. Maximum Pulse Current Vs. Ambient Temperature. Derated Based on $T_A = 25^\circ\text{C}$, $R_{\theta J-A} = 110^\circ\text{C/W}$.

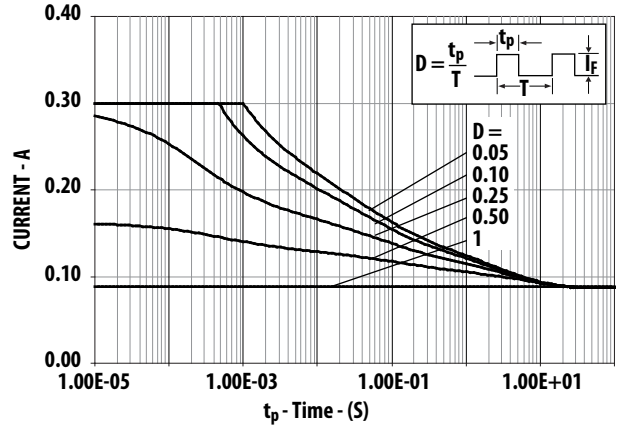

Figure 7b. Maximum Pulse Current Vs. Ambient Temperature. Derated Based on $T_A = 85^\circ\text{C}$, $R_{\theta J-A} = 110^\circ\text{C/W}$.

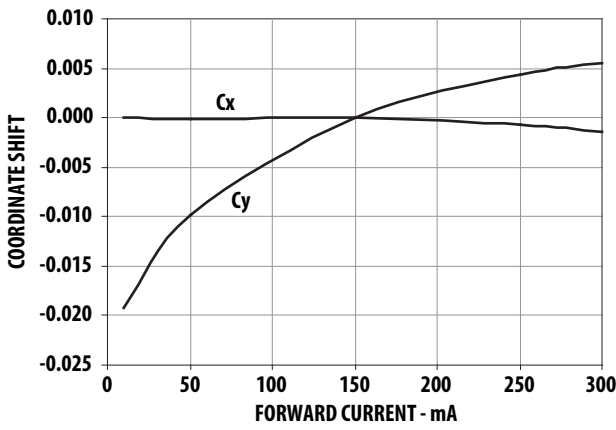

Figure 8. Chromaticity Shift Vs. Forward Current

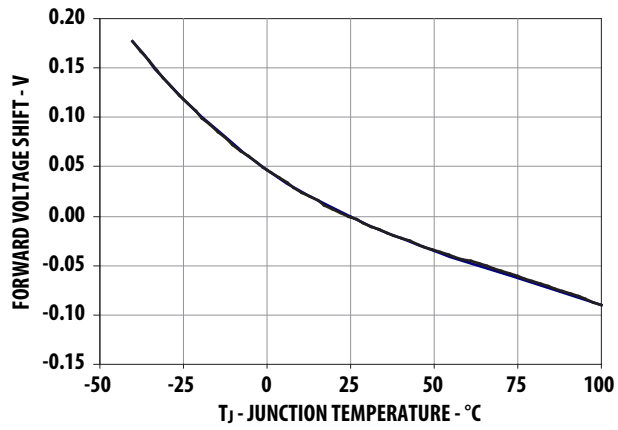

Figure 9. Forward Voltage Shift Vs. Temperature.

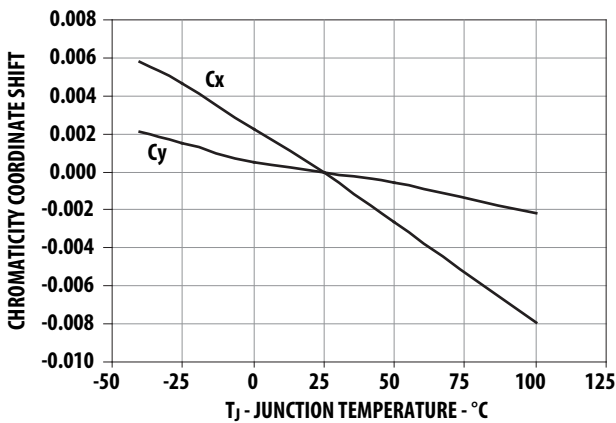

Figure 10. Chromaticity Shift Vs. Temperature

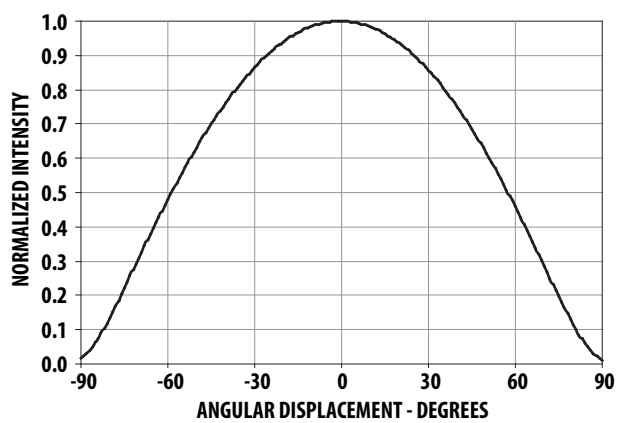
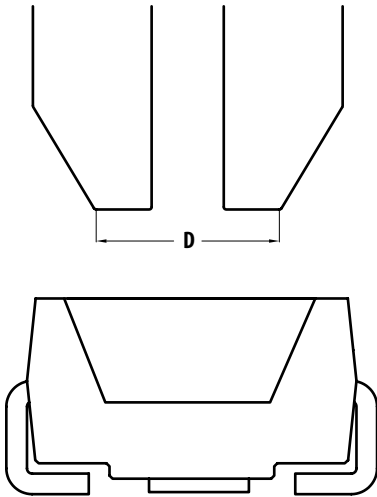
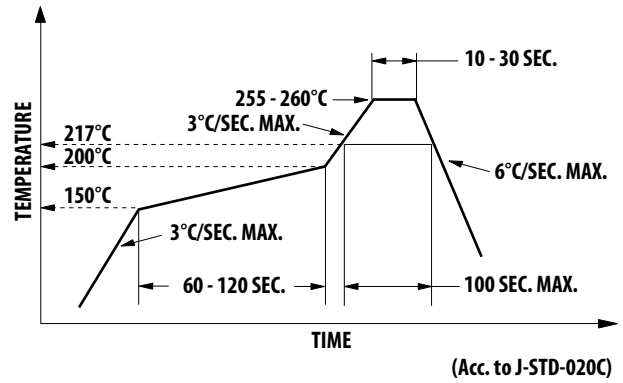

Figure 11. Radiation Pattern



Note: Diameter "D" should be smaller than 2.2mm

Figure 12. Recommended Pick and Place Nozzle Size



Note: For detail information on reflow soldering of Avago surface mount LEDs, do refer to Avago Application Note AN 1060 Surface Mounting SMT LED Indicator Components.

Figure 13. Recommended Pb-free Reflow Soldering Profile

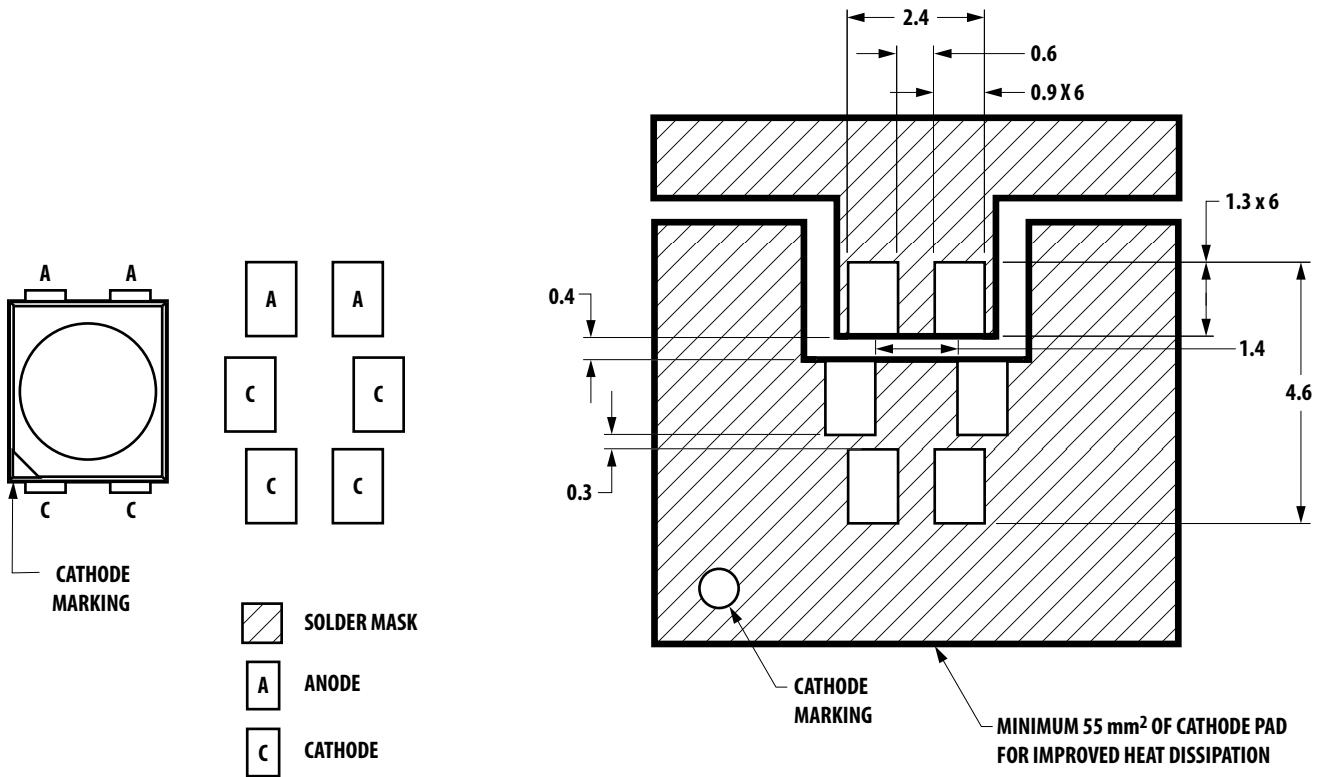

Figure 14. Recommended Soldering Pad Pattern

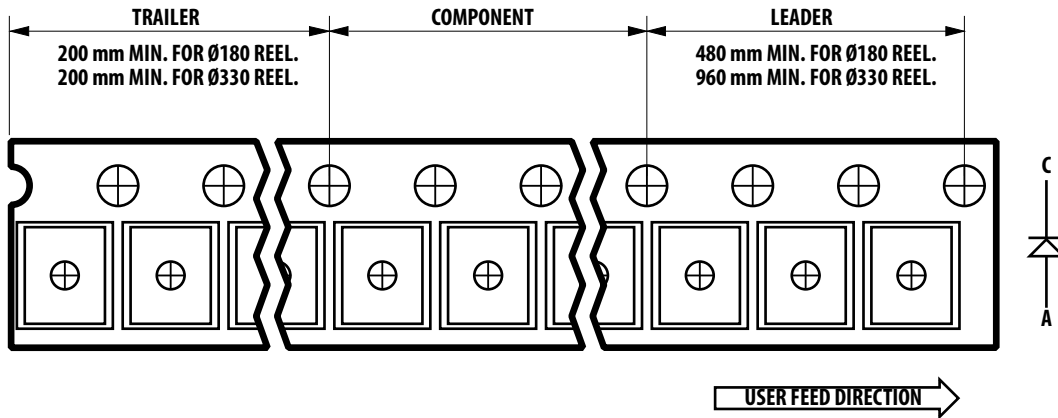

Figure 15. Tape Leader and Trailer Dimensions

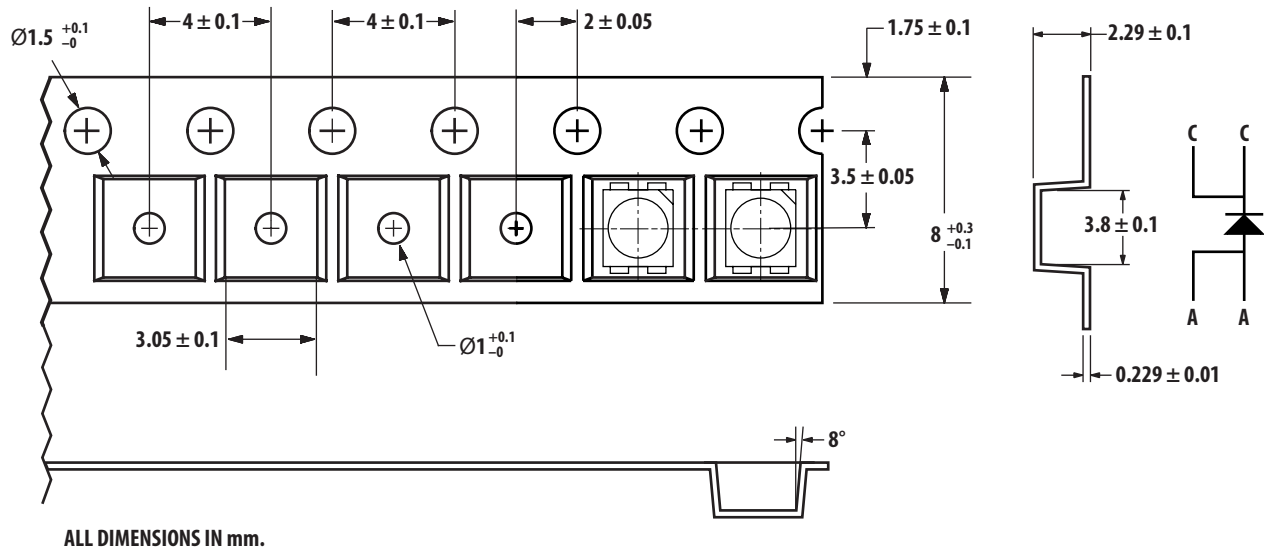

Figure 16. Tape Dimensions

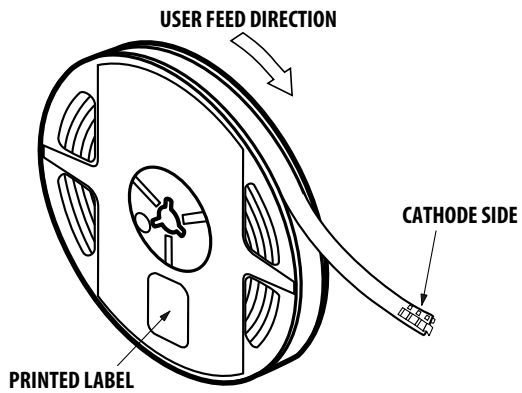

Figure 17. Reeling Orientation

Handling Precaution

The encapsulation material of the product is made of silicone for better reliability of the product. As silicone is a soft material, please do not press on the silicone or poke a sharp object onto the silicone. These might damage the product and cause premature failure. During assembly or handling, the unit should be held on the body only. Please refer to Avago Application Note AN 5288 for detail information.

Moisture Sensitivity

This product is qualified as Moisture Sensitive Level 2 per Jedec J-STD-020. Precautions when handling this moisture sensitive product is important to ensure the reliability of the product. Do refer to Avago Application Note AN5305 Handling of Moisture Sensitive Surface Mount Devices for details.

A. Storage before use

- Unopen moisture barrier bag (MBB) can be stored at <40°C/90%RH for 12 months. If the actual shelf life has exceeded 12 months and the HIC indicates that baking is not required, then it is safe to reflow the LEDs per the original MSL rating.
- It is not recommended to open the MBB prior to assembly (e.g. for IQC).

B. Control after opening the MBB

- The humidity indicator card (HIC) shall be read immediately upon opening of MBB.
- The LEDs must be kept at <30°C/60%RH at all time and all high temperature related process including soldering, curing or rework need to be completed within 1 year.

C. Control for unfinished reel

- For any unuse LEDs, they need to be stored in sealed MBB with desiccant or desiccator at <5%RH.

D. Control of assembly boards

- If the PCB soldered with the LEDs is to be subjected to other high temperature processes, the PCB need to be stored in sealed MBB with desiccant or desiccator at <5%RH to ensure no LEDs have exceeded their floor life of 1 year.

E. Baking is required if

- “60%” HIC indicator is NOT blue.
- The LEDs are exposed to condition of >30°C/60% RH at any time.
- The LEDs floor life exceeded 1 year.

Recommended baking condition: 60±5°C for 20 hours.

Device Color (X₁)

Y	Warm White
---	------------

Flux Bin Select (X₂X₃)

Individual reel will contain parts from one bin only

X ₂	Min Flux Bin
X ₃	Max Flux Bin

Flux Bin Limits

Bin ID	Min. (lm)	Max. (lm)
B	5.50	7.00
C	7.00	9.00
D	9.00	11.50
E	11.50	15.00
F	15.00	19.50
G	19.50	25.50
H	25.50	33.00
J	33.00	43.00
K	43.00	56.00
L	56.00	73.00

Tolerance of each bin limit = ± 12%

Color Bin Select (X₄)

Individual reel will contain parts from one sub bin only.

X ₄	Full Distribution
0	
A	H, J and K only
B	H, J, K, L and M only
C	L and M only
D	L, M, N and P only
E	N and P only
F	N, P, Q and R only
G	Q and R only
Z	Special Color Bin

Color Bin Limits

Bin ID	Sub Bin ID	Limits (Chromaticity Coordinates)				
H	H3	x	0.348	0.360	0.364	0.350
		y	0.332	0.341	0.358	0.348
	H4	x	0.350	0.364	0.367	0.352
		y	0.348	0.358	0.376	0.365
	H5	x	0.352	0.367	0.371	0.354
		y	0.365	0.376	0.392	0.381
J	J3	x	0.360	0.373	0.378	0.364
		y	0.341	0.350	0.368	0.358
	J4	x	0.364	0.378	0.383	0.367
		y	0.358	0.368	0.386	0.376
	J5	x	0.367	0.383	0.388	0.371
		y	0.376	0.386	0.403	0.392
K	K3	x	0.373	0.387	0.393	0.378
		y	0.350	0.358	0.376	0.368
	K4	x	0.378	0.393	0.399	0.383
		y	0.368	0.376	0.395	0.386
	K5	x	0.383	0.399	0.405	0.388
		y	0.386	0.395	0.412	0.403
L	L3	x	0.387	0.400	0.407	0.393
		y	0.358	0.366	0.384	0.376
	L4	x	0.393	0.407	0.414	0.399
		y	0.376	0.384	0.402	0.395
	L5	x	0.399	0.414	0.421	0.405
		y	0.395	0.402	0.420	0.412
M	M3	x	0.400	0.413	0.421	0.407
		y	0.366	0.372	0.390	0.384
	M4	x	0.407	0.421	0.429	0.414
		y	0.384	0.390	0.409	0.402
	M5	x	0.414	0.429	0.436	0.421
		y	0.402	0.409	0.426	0.420

Bin ID	Sub Bin ID	Limits (Chromaticity Coordinates)				
N	N3	x	0.413	0.425	0.434	0.421
		y	0.372	0.378	0.396	0.390
	N4	x	0.421	0.434	0.443	0.429
		y	0.390	0.396	0.414	0.409
	N5	x	0.429	0.443	0.451	0.436
		y	0.409	0.414	0.430	0.426
P	P3	x	0.425	0.438	0.447	0.434
		y	0.378	0.382	0.400	0.396
	P4	x	0.434	0.447	0.456	0.443
		y	0.396	0.400	0.417	0.414
	P5	x	0.443	0.456	0.465	0.451
		y	0.414	0.417	0.434	0.430
Q	Q3	x	0.438	0.450	0.460	0.447
		y	0.382	0.386	0.403	0.400
	Q4	x	0.447	0.460	0.470	0.456
		y	0.400	0.403	0.420	0.417
	Q5	x	0.456	0.470	0.479	0.465
		y	0.417	0.420	0.436	0.434
R	R3	x	0.450	0.462	0.472	0.460
		y	0.386	0.389	0.405	0.403
	R4	x	0.460	0.472	0.482	0.470
		y	0.403	0.405	0.422	0.420
	R5	x	0.470	0.482	0.491	0.479
		y	0.420	0.422	0.437	0.436

Tolerance of each bin limit = ± 0.02 .

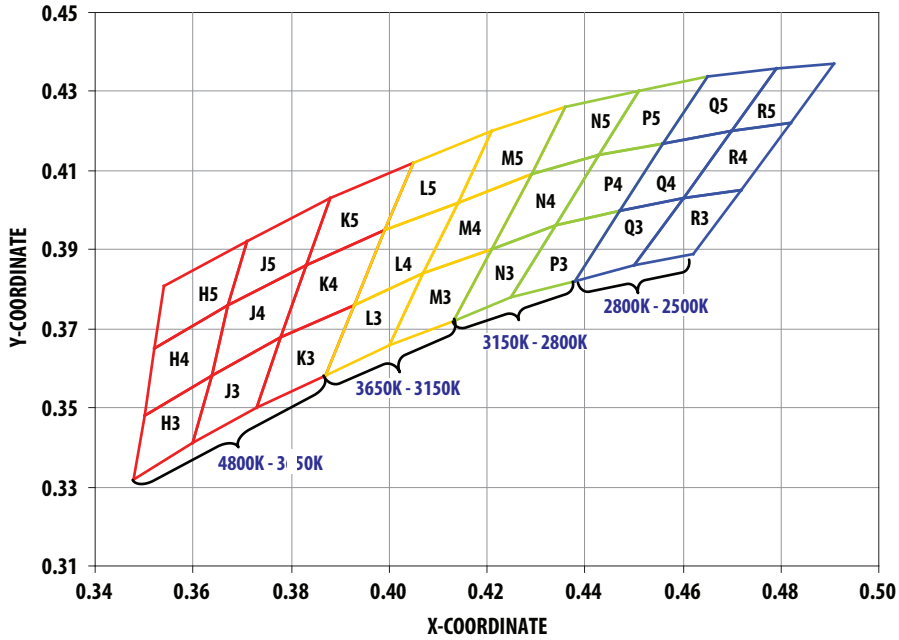

V_F Bin Limits

Bin ID	Min.	Max.
S4	2.90	3.20
S5	3.20	3.50
S6	3.50	3.80

Tolerance of each bin limit = $\pm 0.1V$

Packaging Option (X₅)

Option	Test Current	Package Type	Reel Size
E	150mA	Top Mount	7 Inch

For product information and a complete list of distributors, please go to our web site: www.avagotech.com

Avago, Avago Technologies, and the A logo are trademarks of Avago Technologies in the United States and other countries. Data subject to change. Copyright © 2005-2009 Avago Technologies. All rights reserved. AV02-1745EN - June 16, 2009

AVAGO
TECHNOLOGIES