

TOSHIBA LED lamp

TL30W01-D(T36)

○ **Surface-mount devices**

- 4.5 (L) mm × 2.0 (W) mm × 0.8 (H) mm
- High luminous flux: 19 lm(typ.)@150 mA
- Color: White
- Topr / Tstg: -40 to 100°C
- Reflow-solderable
- Standard embossed tape packing: T36 (1,000 / reel), 4-mm pitch
- Applications: LCD backlighting and so on

Unit: mm

Color and Material

Part Number	Color	Material
TL30W01-D(T36)	White	InGaN

Absolute Maximum Ratings (Ta = 25°C)

Characteristics	Symbol	Rating	Unit
Forward Current (Note 2)	I_F	180	mA
Power Dissipation	P_D	684	mW
Operating Temperature	T_{opr}	-40 to 100	°C
Storage Temperature	T_{stg}	-40 to 100	°C
Junction Temperature	T_j	140	°C

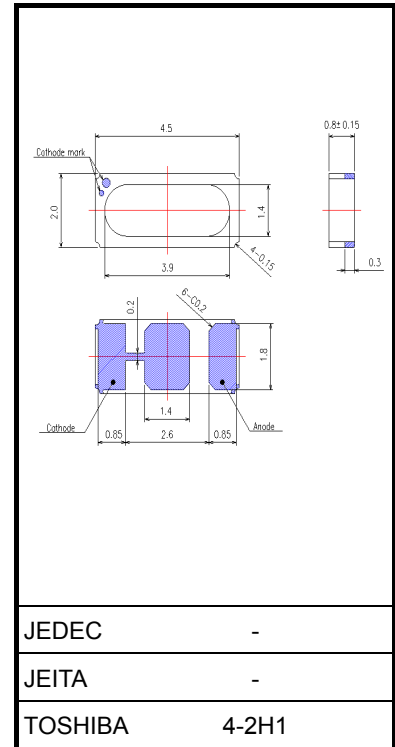

Weight: 0.02 g (typ.)

Note 1: Using continuously under heavy loads (e.g. the application of high temperature/current/voltage and the significant change in temperature, etc.) may cause this product to decrease in the reliability significantly even if the operating conditions (i.e. operating temperature/current/voltage, etc.) are within the absolute maximum ratings. Please design the appropriate reliability upon reviewing the Toshiba Semiconductor Reliability Handbook (“Handling Precautions”/“Derating Concept and Methods”) and individual reliability data (i.e. reliability test report and estimated failure rate, etc).

Note 2: The junction-to-ambient thermal resistance, $R_{th(j-a)}$, should be kept below 140°C/W so that the TL30W01-D(T36) is not exposed to a condition beyond the absolute maximum ratings. $R_{th(j-a)}$: Thermal resistance from the LED junction to ambient temperature

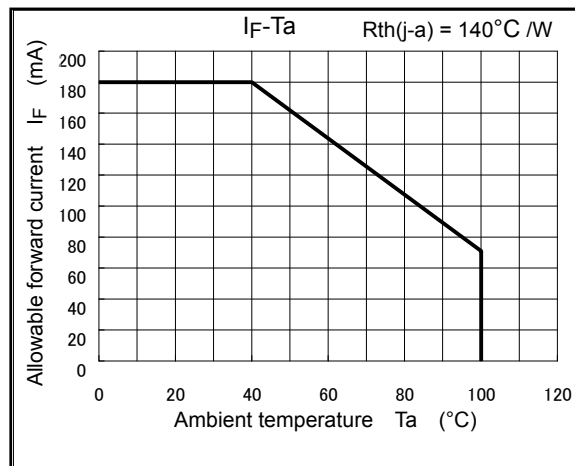

Electrical Characteristics (Ta = 25°C)

Characteristics	Symbol	Test condition	Min.	Typ.	Max.	Unit
Forward Voltage (Note 3)	V_F	$I_F = 150 \text{ mA}$	3.0	—	3.8	V
Reverse Voltage	V_R	$I_R = 10 \text{ mA}$	—	0.75	—	V

Note 3: V_F rank classification:

The specification on the below table is used for V_F classification of LEDs in Toshiba facility.
 Each reel includes the same rank LEDs. Please note the delivery ratio of each rank be unquestioned.
 Accuracy $\pm 0.05\text{V}$

Part Number	Forward Voltage V_F		I_F
	Min	Max	
TL30W01-D(T36)	3.0	3.8	150
	VF2	3.4	
	VF1	3.0	
Unit	V		mA

Optical Characteristics (Ta = 25°C)

Characteristics	Symbol	Test condition	Min	Typ.	Max	Unit
Chromaticity	C_x	$I_F = 150 \text{ mA}$	(Note 4)			—
	C_y	$I_F = 150 \text{ mA}$	(Note 4)			—
Luminous flux	F	$I_F = 150 \text{ mA}$	(Note 5)	19	(Note 5)	lm

Note 4: Chromaticity classification:

The specification on the below table is used for C_x/C_y classification of LEDs in Toshiba facility.
 Each reel includes the same rank LEDs. Please note the delivery ratio of each rank be unquestioned.
 Accuracy ± 0.01

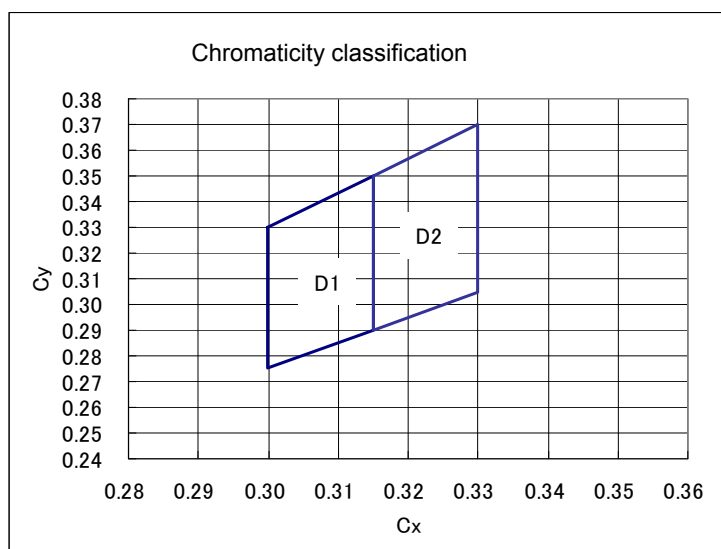

	C_x	C_y
D1	0.300	0.330
	0.300	0.275
	0.315	0.290
	0.315	0.350
D2	0.315	0.350
	0.315	0.290
	0.330	0.305
	0.330	0.370

Note 5: F rank classification:

The specification on the below table is used for Iv classification of LEDs in Toshiba facility.
 Each reel includes the same rank LEDs. Let the delivery ratio of each rank be unquestioned.
 Accuracy $\pm 10\%$

Part Number	Luminous flux F		I _F	
	Min	Max		
TL30W01-D(T36)		15.1	25.5	150
	F4	21.4	25.5	
	F3	18.0	21.4	
	F2	15.1	18.0	
Unit	lm		mA	

Package Dimensions

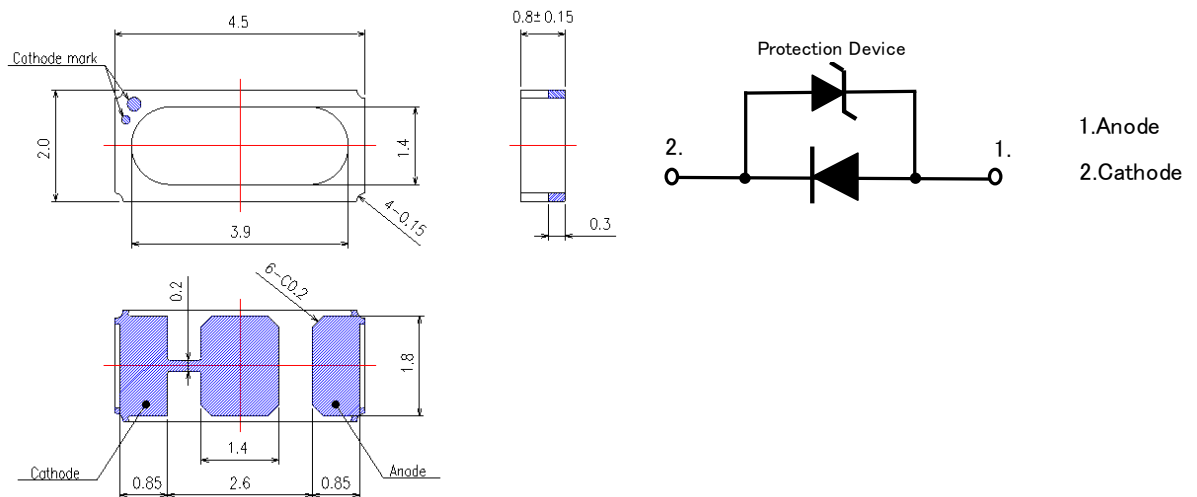

Precaution for ESD Protection and Applications

- The product is sensitive to electrostatic and care must be fully taken when handling products. Particularly in the case that an over-voltage shall be applied, the overflowed energy may cause damage to or possibly result in destruction of the product. Customer shall take absolutely secure countermeasures against electrostatic and surge when handling the product.
- This product is designed for general light source usage and it has applied the measurement standard that matched with the sensitivity of human's eyes. Therefore, it is not intended for usage of functional application (e.g. Light source for sensor, optical communication and etc).

Initial Electrical/ Optical Characteristics

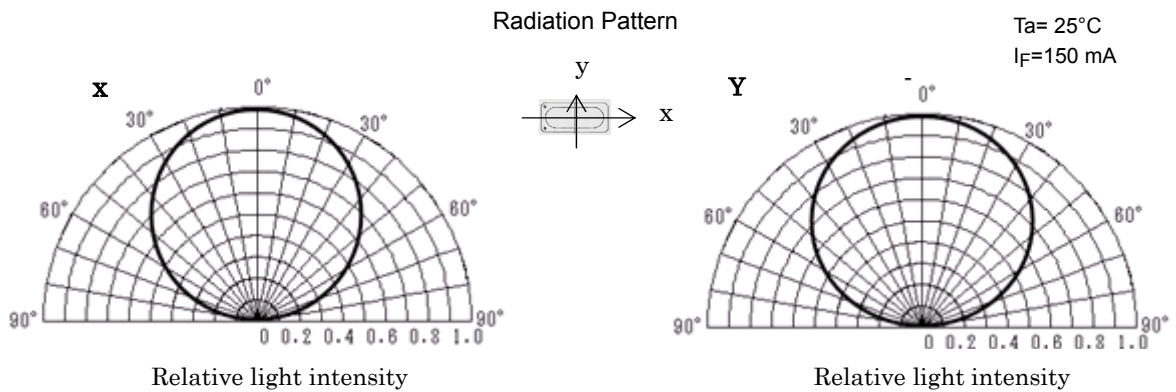
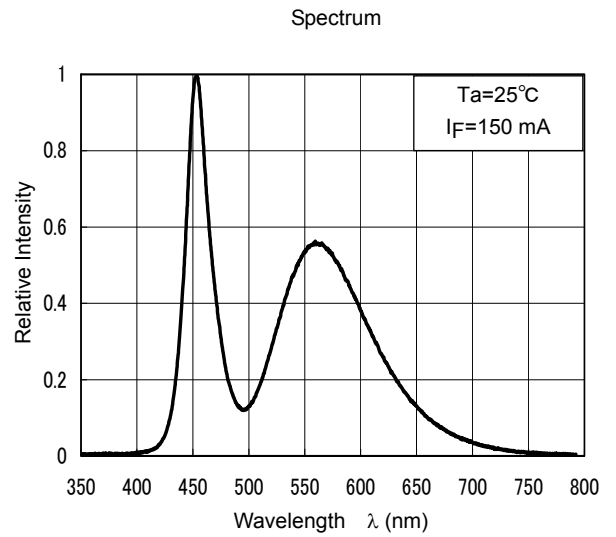
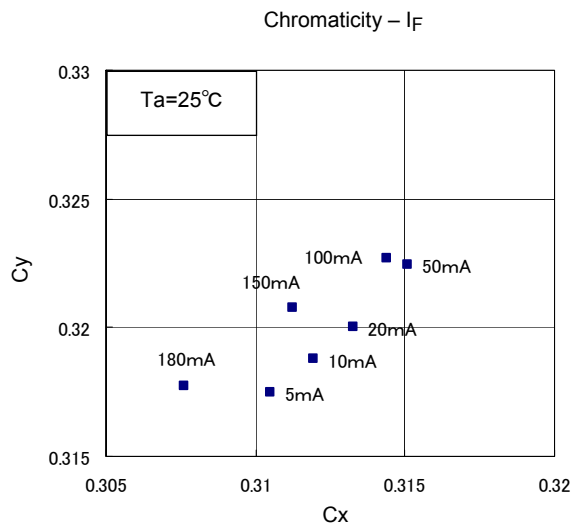
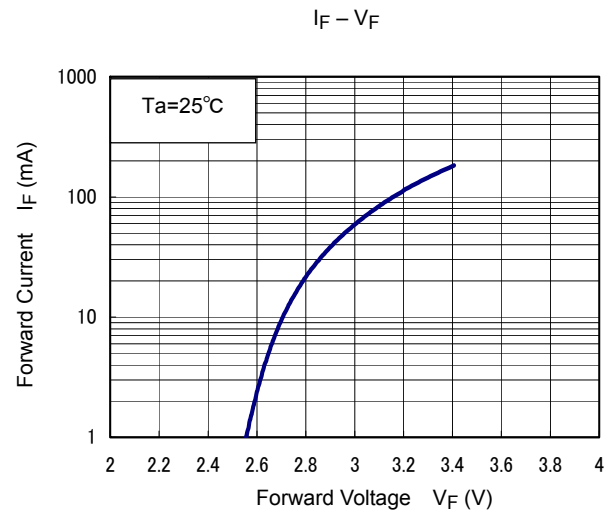
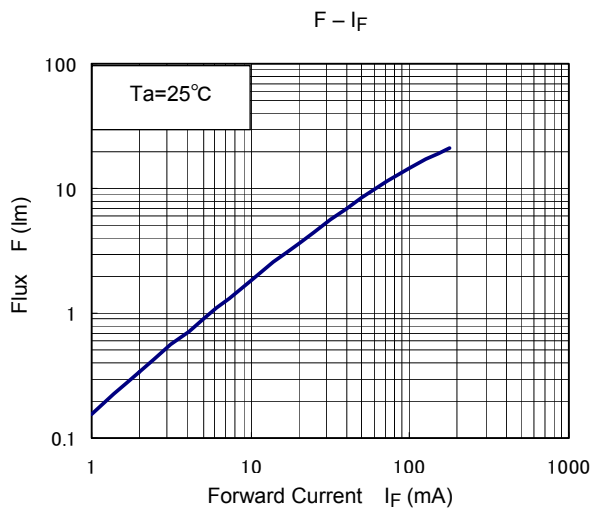

Note 6: Please note that all above graph shown are typical reference data point and not guarantee specifications

Packaging

This LED device is packed in an aluminum envelope with a silica gel and a moisture indicator to avoid moisture absorption. The optical characteristics of the devices may be affected by exposure to moisture in the air before soldering and they should therefore be stored under the following conditions:

1. This moisture proof bag may be stored unopened within 12 months at the following conditions.
 Temperature: 5°C to 30°C
 Humidity: 90% (max)
2. After opening the moisture proof bag, the device should be assembled within 168 hours in an environment of 5°C to 30°C/60% RH or below.
3. If upon opening, the moisture indicator card shows humidity 30% or above (Color of indication changes to pink) or the expiration date has passed, the devices should be baked in taping with reel.
 After baking, use the baked devices within 72 hours, but perform baking only once.
 Baking conditions: 60±5°C, for 24 to 48 hours.
 Expiration date: 12 months from sealing date, which is imprinted on the label affixed.
4. Repeated baking can cause the peeling strength of the taping to change, then leads to trouble in mounting.
5. If the packing material of laminate would be broken, the hermeticity would deteriorate. Therefore, do not throw or drop the packed devices.

Mounting Method

Soldering

- Reflow soldering (example)

Temperature profile for Pb soldering (example)

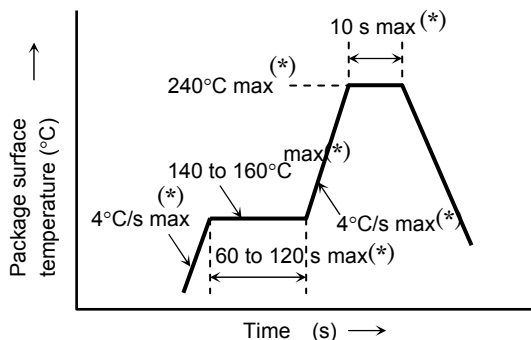

Temperature profile for Pb-free soldering (example)

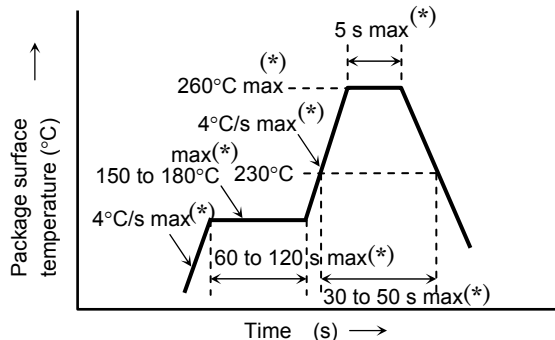

- The product is evaluated using above reflow soldering conditions. No additional test is performed exceed the condition (i.e. the condition more than (*)MAX values) as a evaluation. Please perform reflow soldering under the above conditions.
- Please perform the first reflow soldering with reference to the above temperature profile and within 168 h of opening the package.
- Second reflow soldering
 In case of second reflow soldering should be performed within 168 h of the first reflow under the above conditions.
 Storage conditions before the second reflow soldering: 30°C, 60% RH (max)
- When any soldering corrections are made manually, a hot-plate should be used .
 (only once at each soldering point)
 Temperature of a hot plate: 150°C
 Soldering iron: 25 W
 Temperature: 300°C or less
 Time: within 3 s
- If the product needs to be performed by other soldering method (ex. wave soldering), please contact Toshiba sales representative.

Recommended Soldering Pattern

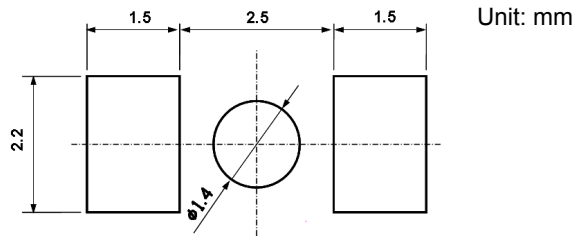

Cleaning

When cleaning is required after soldering, Toshiba recommends the following cleaning solvents. It is confirmed that these solvents have no effect on semiconductor devices in our dipping test (under the recommended conditions). In selecting the one for your actual usage, please perform sufficient review on washing condition, using condition and etc.

ASAHI CLEAN AK-225AES:	(made by ASAHI GLASS)
KAO CLEAN THROUGH 750H:	(made by KAO)
PINE ALPHA ST-100S:	(made by ARAKAWA CHEMICAL)

Precautions when Mounting

Do not apply force to the plastic part of the LED under high-temperature conditions.
To avoid damaging the LED plastic, do not apply friction using a hard material.
When installing the PCB in a product, ensure that the device does not come into contact with other components.

Tape Specifications

1. Product Number Format

The type of package used for shipment is denoted by a symbol suffix after the product number. The method of classification is as below.

- (1) Tape Type: T36 (4-mm pitch)
- (2) Example

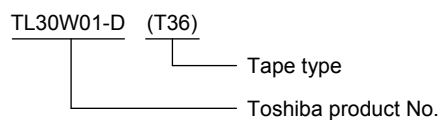

2. Handling Precautions

Tape material protected against static electricity. However static electricity may occur depending on Quantity of charged electricity and a device may attach to a tape, or a device may be unstable when Peeling a tape cover.

- a) Since tape materials may accumulate an electrostatic charge, use an ionizer to neutralize ambient air.
- b) For transport and temporary storage of devices, use containers (boxes and bags) and jigs that are made of antistatic materials or of materials which dissipates electrostatic charges.

3. Tape Dimensions

Unit: mm

Symbol	Dimension	Tolerance
D	1.5	+0.1/-0
E	1.75	±0.1
P ₀	4.0	±0.1
t	0.3	±0.05
F	5.5	±0.05
D ₁	1.1	±0.1

Symbol	Dimension	Tolerance
P ₂	2.0	±0.05
W	12.0	±0.2
P	4.0	±0.1
A ₀	2.2	±0.1
B ₀	4.9	±0.1
K ₀	0.95	±0.1

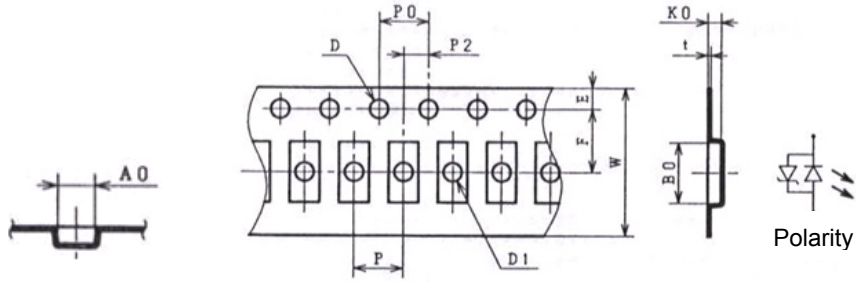

4. Reel Dimensions

Unit: mm

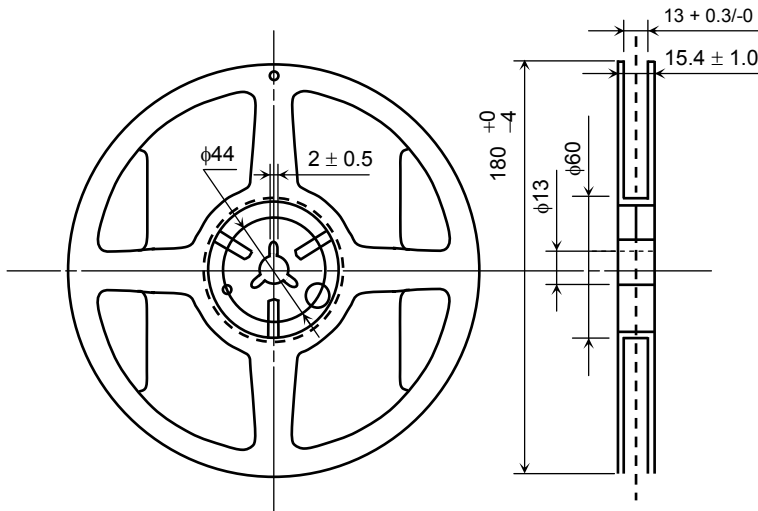

5. Leader and Trailer Sections of Tape

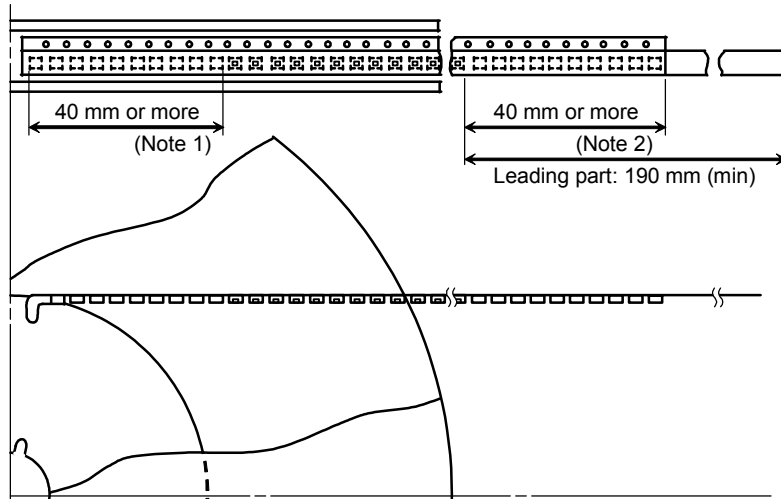

Note 1: Empty trailer section

Note 2: Empty leader section

6. Packing Form

(1) Packing quantity

Reel	1,000 pcs
Carton	4,000 pcs

(2) Packing form: Each reel is sealed in an aluminum pack with silica gel.

7. Label Format

(1) Label contents

Shipped products are mentioned the following contents.



P/N:

TYPE	TL30W01-D		
ADDC	(T36)	Q'TY	1000 pcs

1) xxxxxx 2) xxxxxxxx 4) xxx 5) xxxx
 3) (xxxxxx)
 6) xxxxx-xxxx-xx
 7) Use under 5-30degC/60%RH within 168h

SEALD: xxxxxxxx
 DIFFUSED IN JAPAN
 ASSEMBLED IN JAPAN

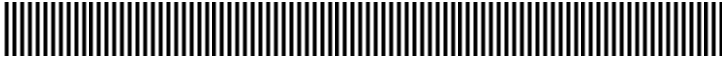
[[G]]/RoHS COMPATIBLE
 Y3804xxxxxxxxxxxxxxxxxxxxx





Contents about Note section (Each example means the contents are different for each lot.)

Information for customers use	Information for Toshiba use
1) Lot code Example: 2707C2B	4) Management code Example: 715 32G
2) Key code Example: 12345678	5) Packing quantity Example: 1000 pcs
3) Rank symbol Example: D1F2VF1	6) Product information E6SM2-YW0M5-06
	7) Storage condition after opening Use under 5 to 30 degC/60%RH within 168h

(2) Label location

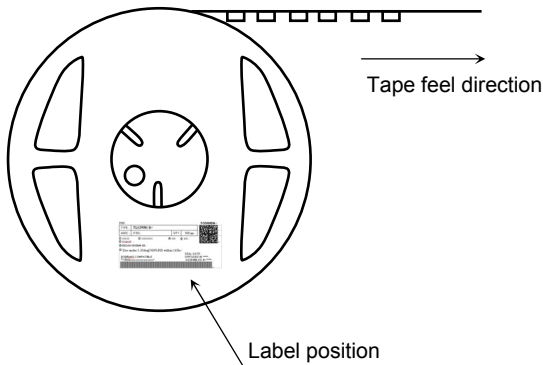
- Reel



- Carton

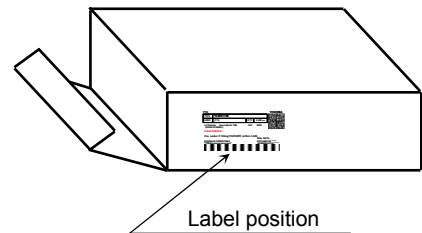

- The aluminum package in which the reel is supplied also has the label attached to center of one side.

RESTRICTIONS ON PRODUCT USE

20070701-EN GENERAL

- The information contained herein is subject to change without notice.
- TOSHIBA is continually working to improve the quality and reliability of its products. Nevertheless, semiconductor devices in general can malfunction or fail due to their inherent electrical sensitivity and vulnerability to physical stress. It is the responsibility of the buyer, when utilizing TOSHIBA products, to comply with the standards of safety in making a safe design for the entire system, and to avoid situations in which a malfunction or failure of such TOSHIBA products could cause loss of human life, bodily injury or damage to property.
In developing your designs, please ensure that TOSHIBA products are used within specified operating ranges as set forth in the most recent TOSHIBA products specifications. Also, please keep in mind the precautions and conditions set forth in the "Handling Guide for Semiconductor Devices," or "TOSHIBA Semiconductor Reliability Handbook" etc.
- The TOSHIBA products listed in this document are intended for usage in general electronics applications (computer, personal equipment, office equipment, measuring equipment, industrial robotics, domestic appliances, etc.). These TOSHIBA products are neither intended nor warranted for usage in equipment that requires extraordinarily high quality and/or reliability or a malfunction or failure of which may cause loss of human life or bodily injury ("Unintended Usage"). Unintended Usage include atomic energy control instruments, airplane or spaceship instruments, transportation instruments, traffic signal instruments, combustion control instruments, medical instruments, all types of safety devices, etc.. Unintended Usage of TOSHIBA products listed in this document shall be made at the customer's own risk.
- The products described in this document shall not be used or embedded to any downstream products of which manufacture, use and/or sale are prohibited under any applicable laws and regulations.
- Please contact your sales representative for product-by-product details in this document regarding RoHS compatibility. Please use these products in this document in compliance with all applicable laws and regulations that regulate the inclusion or use of controlled substances. Toshiba assumes no liability for damage or losses occurring as a result of noncompliance with applicable laws and regulations.