

A^{RF52} Bluetooth® Modules

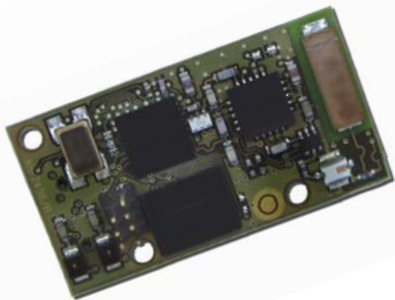

User Guide

No part of this document may be reproduced or transmitted (in electronic or paper version, photocopy) without Adeunis RF consent.

This document is subject to change without notice.

All trademarks mentioned in this guide are the property of their respective owner.

ADEUNIS RF

283, rue Louis Néel

38920 Crolles

France

Phone +33 (0)4 76 92 07 77

Fax +33 (0)4 76 08 97 46

Ref. 08-12-V5-pcy

Table of Contents

Table of Contents	1
About this Document	2
Declaration of conformity	3
Overview	4
Interface	4
Mechanical specification.....	4
Signal description.....	6
Profiles	7
SPP wiring and configuration.....	7
DUN wiring and configuration	8
Module operating mode	9
Command mode.....	10
Transparent mode.....	10
Remote control configuration	11
AT Commands	11
Description	11
Set of commands	12
Register description.....	14
Recommended exclusion zone around antenna	18
Specifications	19
Annex 1 : Firmware and document updates	21

About this Document

This guide describes the A^{RF52} devices, their options and accessories.

Declaration of conformity



Manufacturer's name: **ADEUNIS R.F.**
 Manufacturer's address: Parc Technologique PRE ROUX IV
 283 rue Louis NEEL
 38920 CROLLES - FRANCE

declares that the product if used and installed according to the user guide available on our web site www.adeunis-rf.com

Product Name: **ARF52**
 Product Number(s): **ARF7456A**

is designed to comply with the RTTE Directive 99/5/EC:

EMC: according to the harmonized standard EN 301 489.
 Safety: according to the standard EN 60950-1/2001
 Radio: according to harmonized standard EN 300-328 covering essential radio requirements of the RTTE directive.
 Notes: - Conformity has been evaluated according to the procedure described in Annex III of the RTTE directive.
 - Receiver class (if applicable): 3.

According to the 1999/519/EC recommendation, minimum distance between the product and the body could be required depending on the module integration.

Warning: - CE marking applies only to End Products: Because this equipment is only a subassembly, conformity testing has been reduced (equipment has been design in accordance to standards but full testing is impossible). Manufacturer of End Products, based on such a solution, has to insure full conformity to be able to CE label marking.

- As the integration of a radio module requires wireless technological knowledge, ADEUNIS RF proposes its technical proficiency to its customers for a pre-compliance qualification of end products. In case of no-conformity, ADEUNIS RF will not be held back responsible if this stage has not been realised.

Crolles, November 6th, 2007
 VINCENT Hervé / Quality manager

A handwritten signature in black ink, appearing to be 'V. Hervé', is written over the printed name of the quality manager.

Download of the user guide

Thank you for having chosen the ADEUNIS RF products.

User guides can be uploaded directly on our web site www.adeunis-rf.com

Index **Products**

Paragraph **OEM Modules > Bluetooth® Module**

Print version available upon request

✓ Tel : +33 4 76 92 07 77
 ✓ Email : arf@adeunis-rf.com

Ref. 08-12-V5-pcy

Overview

The A^{RF52} Bluetooth class 1 module enables Bluetooth® compliant duplex communications over a 150-meter range in the worldwide 2.45 GHz frequency band.

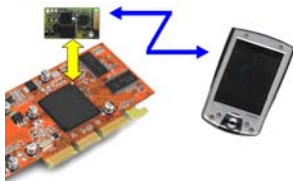

The A^{RF52} module fully complies with the V2.0+EDR Bluetooth® standard and data rate goes up to 3 Mbps. Data exchange and set-up are only done through an UART data port, under SPP profile. A miniature antenna is integrated.

A^{RF52} can be used in two modes : command mode and transparent mode. The command mode is used to established Bluetooth communications and set/get parameters. The transparent mode is used for data exchange. The module converts data from a serial link into a Bluetooth® radio frame to be sent to a similar piece of equipment. The communication is half-duplex. The operating parameters of the Bluetooth module (serial link, Bluetooth® management...) can be fully updated through AT commands via the serial link. A^{RF52} modules are available as standalone ARF7456 module or in a DemoKit. This DemoKit can be fully set-up using a PC terminal. We recommend reading the "specification of the Bluetooth® system core 2.0 + EDR" document available at the www.bluetooth.com web site.

Interface

Mechanical specification (cf next page)

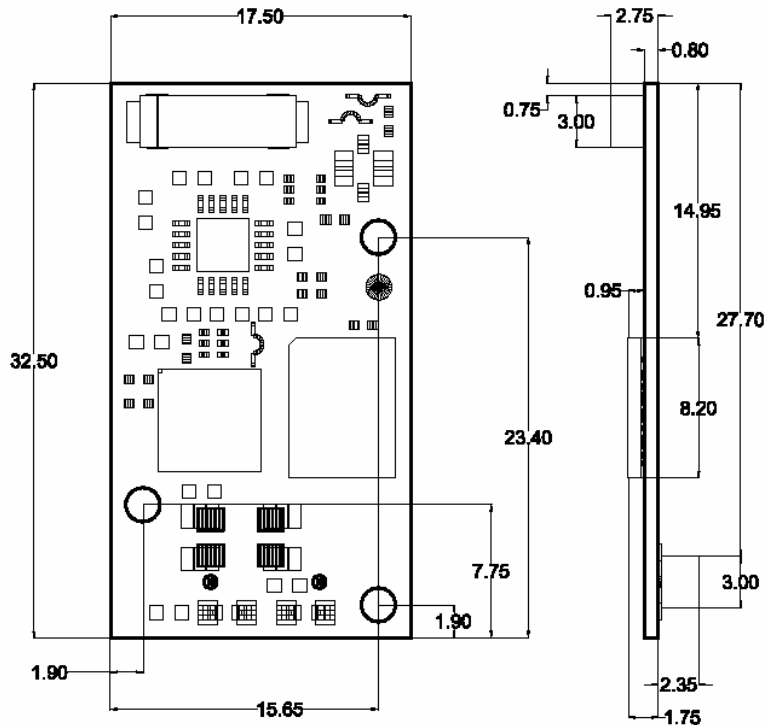

VUE COTE CONNECTEUR

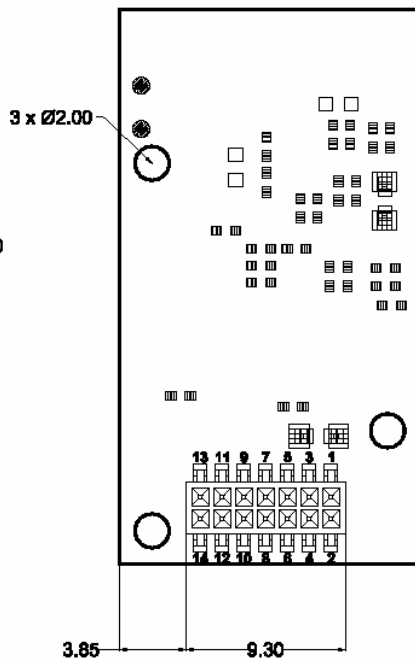

- 1 : GND
- 2 : UART_CTS
- 3 : UART_RTS
- 4 : UART_TX
- 5 : PIO(6) ... DSR
- 6 : UART_RX
- 7 : PIO(5) ... RI
- 8 : PIO(4) ... DCD
- 9 : PIO(7) ... DTS
- 10 : (S)GND
- 11 : (S)GND
- 12 : RESET
- 13 : 3V3
- 14 : 3V3_PA



Les informations contenues dans ce document sont la propriété exclusive de Adsunis-RF et ne peuvent être reproduites, utilisées ou divulguées à des tiers quelle qu'elle soient sans son accord écrit.

VER	DATE	AUTEUR	MODIFICATIONS

Adsunis RF
Solutions pour votre projet

DOCUMENT

Z456_C-M01_V1.0

PROJET

PLAN D'ENCOMBREMENT

MODULE BLUETOOTH

N° 1 / 1

Signal description

14 pins 1,27mm male SMD connector.

Interface Pin	Name	I/O	Description
<i>Digital interface</i>			
1,10,11	GND		Ground
13	VDD_DIG		Digital voltage 3,3V +/- 10%
14	VDD_ANA		Analog voltage 3,3V +/- 10%
4	TXD	O	Serial data transmission
6	RXD	I	Serial data reception
2	/CTS	I	Clear To Send CTS = GND, the DCE is able to receive serial data CTS = VDD, serial data received by the DCE are lost
3	/RTS	O	Request To Send RTS = GND, the DTE is able to receive serial data RTS = VDD, serial data received by the DTE are lost
12	/RESET	I	Reset signal
9 (PIO7)	DTR	I/O	Data Terminal ready Output for the Slave Input for the Master
5 (PIO6)	DSR	I/O	Data Set Ready Input for the Slave Output for the Master
7 (PIO5)	RI	I/O	Ring Input for the Slave Output for the Master
8 (PIO4)	DCD	I/O	Data Carrier Detect Input for the Slave Output for the Master

Profiles

The module supports 2 different profiles: **SPP and DUN**.

A basic module configuration is provided as a guideline for each profile (for more details or customisation see § AT commands).

The module can be configured using a terminal at 9600 baud, 8 bits, 1 stop, HW flow control (default serial configuration)

SPP wiring and configuration

SPP (Serial Port Profile) is the standard Bluetooth® profile.

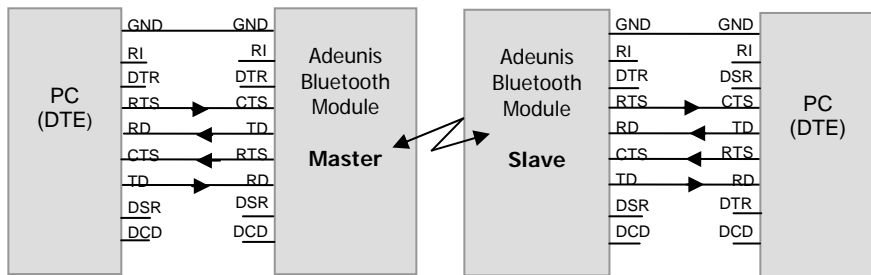

SPP configuration guideline : in the following example, the Master is configured to performed an auto-connection on reset.

1. Master configuration : enters the command mode using the A+++ sequence. When the <OK> answer is receive, send the following commands:
2.
 - ATS202=1 (auto-connect on reset)
 - ATS220=1 (SPP profil, default value)
 - ATS203= slave BT address (use ATINQ 0,10 command to discover the slave @)
 - AT&W (save the configuration)

3. Slave configuration : enters the command mode and then send the following commands:
 - ATS202=0 (auto-connect disable, default value)
 - ATS220=1 (SPP profil)
 - AT&W (save the configuration)
4. Perform a power cycle on both modules. The modules are now in transparent mode; the link will be established automatically on reset by the master.

When the link is established data can be exchanged using the serial link.
5. Caution the BT connection establishment can take up to 10 seconds (you can check this establishment in command mode using the AT&L command).

DUN wiring and configuration

DUN (Dial up Network) profile is above the SPP profile. This profile manages the 4 lines DTR, DSR, DCD and RI and is dedicated to PSTN or GSM modems.

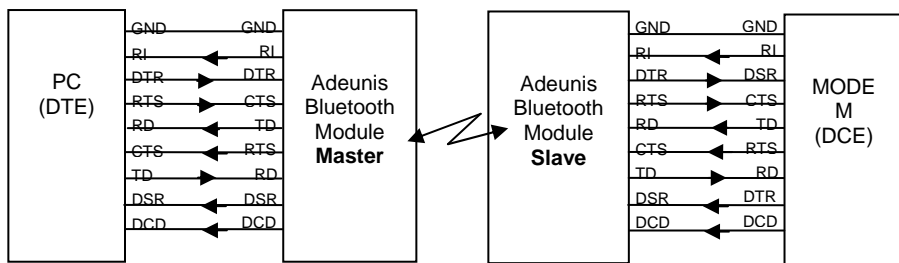

DUN configuration guideline : in the following example, the Master is configured to performed an auto-connection on DSR.

1. Master configuration : enters the command mode using the A+++ sequence. When the <OK> answer is receive, send the following commands:
 AT202=2 (auto-connect on DTR)
 AT220=2 (Dun profil)
 AT203= slave BT address (use ATINQ 0,10 command to discover the slave @)
 AT&W (save the configuration)
2. Slave configuration : enters the command mode and then send the following commands :
 AT202=0 (auto-connect disable, default value)
 AT220=2 (Dun profil) AT&W (save the configuration)
3. Exit the command mode or perform a power cycle on both modules. The modules are now in transparent mode; the link will be established when the DTR is activated on the master. When the link is established data can be exchanged using the serial link.
4. Caution the BT connection establishment can take up to 10 seconds (you can check this establishment either in command mode using the AT&L command or by checking report of a remote signal).

DTR/DSR/RI and DCD I/O configuration :

- These lines are set as inputs while the connection is not established or released,
- And set as input and output according to the DUN illustration and to the description done in signal description table.

Module operating mode

Two operating modes are available :

- Command mode (usage of AT commands and SPP_CONFIG mode)
- Transparent mode (serial data are transmitted on radio link).

At power up the transceiver is in transparent mode according to the registers configuration. The boot time is about 1s.

Ref. 08-12-V5-pcy

Command mode

The command mode is used to read and update the modem configuration registers using AT commands.

In command mode, the radio is inhibited (reception and transmission), excepted when using test command.

Entering command mode : issues on the serial link a A+++ sequence. The sequence A+++ characters is accepted only if no character has been seen before and after the A+++ sequence. Register (S214) defines the silence duration.

Tips : if you are using a terminal (such as Hyperterm), you have to send the A+++ sequence using a text file (first create a text file containing only the A+++ characters, and then use in Hyperterm the command "Send text file" in the "Transfer menu")

Exiting command mode (return back in transceiver mode) : send the serial command

ATO <cr>

Transparent mode

In transparent mode, data received from the serial link are transmitted on the radio link. When data are received on the radio link, these data are sent on the serial link.

Remote control configuration

SPP_CONFIG mode is used to remotely configure the slave module through the master module serial link. This is done, on master side, in 4 steps :

Activation of the SPP_CONFIG mode using the ATC1 command. When this mode is activated, the command issued on the master will be ignored by the master and transmitted to the slave by radio.

Slave configuration : send command to the slave using the Master serial link. When the remote configuration is done, the master must send an AT&W command to the slave (the AT&W command is mandatory because the slave reboots when the master leaves the SPP_CONFIG mode or when the RF link is loosed).

Leaving of the SPP_CONFIG mode using the ATC0 command.

AT Commands

Description

AT commands are interpreted only when the module is in Command mode.

Commands : are used to read and update the modem parameters
A command starts with the 2 ASCII 'AT' characters. 'AT' means 'Attention'
follow with one or several characters or other data.
Each command is ended with <cr> (carriage return).
In the same command, the time between 2 characters must be less than 10s.

Response : is sent back for each command on the serial link. The answer is:
<cr><lf 'OK'<cr><lf> (ASCII character 0x4F) for accepted command (or OK command)
<cr><lf 'ERROR'<cr><lf> for error

- Specific string when specified

Ref. 08-12-V5-pcy

Set of commands

The SPP CONFIG column indicates whether the command is available or not when the module is in SPP CONFIG mode (ATC1 command).

Commands	Description	SPP CONFIG
	<i>Operating mode selection</i>	
ATO	Return back to transparent mode.	NO
<silence> A+++ <silence>	Command mode activation. The A+++ sequence must be preceded and followed by a calibrated silence (no other character)	NO
	<i>Registers management</i>	
ATSn?	Displays the Sn register content where n represents the register number. The response has the following format: Sn=y<cr><lf>	YES
ATSn=m	Sets the Sn register value with 'm'. n represents the register number..	YES
AT&W	Saves the new register configuration in EEPROM. Each time you switch on the modem, the EEPROM configuration will be loaded in the modem registers.	YES
AT&V	Displays all register values. The response has the following format: Sxxx=y<cr><lf> for each register.	YES
AT&F	Restore register default values (Refer to Annexe 1 – Page 22)	YES
	<i>BT LINK management</i>	
ATINQ <space>MaxDevice, TimeOut	Launch Bluetooth inquiry of devices for a duration d multiple of 1.28s <1..48>, for maximum n (0=unlimited, 1= one device, ...) devices Return BT address and class of device of each peripheral Example : ATINQ 0,10	NO
ATD <space>Bluetooth address	Establish Bluetooth link with device <Bluetooth address> Link established : answer 'OK'<cr><lf> Link not established : answer 'NO CARRIER'<cr><lf> Example : ATD 0018B2000110	NO
ATH	Release Bluetooth link	NO
AT&L	Link connection status. released or established	NO

AT&RSSI	RSSI indicator Link established : answer -xx dBm<cr><lf> (-45 dBm for example) Link not established : answer 'LINK RELEASED<cr><lf>' <ul style="list-style-type: none"> • RSSI > -70 dBm : Excellent receipt • -70 > RSSI > -80 dBm : Good receipt • -80 > RSSI > -90 dBm : Poor receipt • RSSI < -90 dBm : Bad receipt 	NO
	<i>Miscellaneous</i>	
ATI	Software version display. The response has the following format: Adeunis RF : 7456 Vxx.yy<cr><lf>	YES
ATCO	Exit SPP Config mode	YES
ATC1	Enter SPP Config mode	NO
	<i>Test modes</i>	
AT&T0=xxxx,yy yy,zzzzz	Continuous transmission at xxxx (2402<=xxxx<=2480) MHz, with a designated output power yy (0<=yyyy<=65530) and designated tone modulation frequency zzzzz (0<=zzzzz<=65535). Example : AT&T0=2450,65530,0	NO
AT&T1=xxxx, yyyyy	Enables the transmitter at xxxx (2402<=xxxx<=2480) MHz, with a designated output power yy (0<= yyyyy <=65530). Payload is PRBS9 data. Example : AT&T1=2450,65530	NO
AT&T2=x, yyyyy	Enables the transmitter with a simplified hop sequence designated by the country code x (0<=x<=3), with a designated output power yy (0<=yyyyy<=65535). Payload is PRBS9 data. Example : AT&T2=0,65530	NO
AT&T3=xxxx,y,z z	Enables the receiver in continuous reception at xxxx (2402<=xxxx<=2480) MHz, with a choice of low (y=0) or high (y=1) side modulation and a designated attenuation zz (0<=zz<=15). Example : ATT&T3=2450,0,0	NO
AT&T4=xxxx, yyyyy	Test loopback at xxxx (2402<=xxxx<=2480) MHz, with a designated output power yy (0<= yyyyy <=65530). Example : AT&T4=2450,65530	NO

Register description

The register value could be updated using the ATSn=m<cr> command and displayed using Aton?<cr> command.

At power-up, the previous transceiver configuration is read from E2PROM (non volatile) and stored in RAM. The registers are located in RAM, any modification is performed in RAM: To save current register configurations, it is necessary to use the AT&W<cr> command (If not, the updated parameters are lost in case of power shortage).

The registers are shared in 2 types: read only (R) or read/write (R/W)

Type	Register	Function	Description	Default value	Link disconnection if register value change
			<i>Bluetooth management</i>		
R	S200	Local Bluetooth address	Local Bluetooth address of the module The local BT address is read only.		NO
R/W	S201	Local device name	Device name must be lower or equal than 32 bytes	"Serial Port Device"	YES
R/W	S202	Auto-connect mode	Auto-connect mode : 0 = disable 1 = Auto-connect on reset or power up 2 = Auto-connect on GPIO (DTR)	0	YES
R/W	S203	Remote Bluetooth address	Remote Bluetooth address used with auto-connect mode enabled.	0000000000 00h	YES

R/W	S204	reconnect on managem ent	Reconnection management used with auto-connection mode Send 'NO CARRIER' <cr><lf> in case of no connection 0 : no reconnection N : number of retries (N<>0 and N <>255) 255 : always	255	YES
R/W	S205	Pin code	Pin code of the module must be lower or equal than 16 bytes	0000	YES
R/W	S206	Encryption	Encryption type : '0' = disabled '1' = enabled	0	YES
R/W	S207	Security	Security type : '0' = disabled the pin code demand '1' = enabled the pin code demand	0	YES
R/W	S208	Class of device	0xXXXXXX	000000h	YES
			<i>Serial link</i>		
R/W	S210	Baudrate	Serial link rate in bits/s, IMPORTANT see Note 1 '4': 9 600 '5': 19 200 '6': 38 400 '7': 57 600 '8': 115 200 For baudrates above 115200 bits/s be sure that your system can support the speed. '9' : 230 400 '10' : 460 800 '11' : 921 600	4 (See Note 1)	NO
R/W	S211	Data length	'8' : 8 bits, see Note 1.	8	NO

R/W	S212	Parity	see Note 1. '1' : none '2' : even '3' : odd	1	NO
R/W	S213	Stop bits	see Note 1. '1' : 1 stop bit '2' : 2 stop bit	1	NO
R/W	S214	Command timeout	Time out duration for detecting the A+++ pattern, unit 1/50s (20ms) : from 1 up to 255x50ms.	50	NO
R/W	S215	Flow control	Flow control management : 0 : disable (RTS/CTS management) 1 : enable (RTS/CTS management) Modifying is enable after ATO command which reboot the system.	1	NO
			<i>Protocol</i>		
R/W	S220	Protocol	'1'= SPP '2'= DUN	1	YES
R/W	S230	Sniff mode	0 : not used 1 : very low power consumption and low throughput 2 : low power consumption and medium throughput 3 : low power consumption and maximum throughput 4 : customer sniff mode (Bluetooth expert only) – use parameters S231..S234	0	YES
R/W	S231	Sniff parameter Max interval	see Note 2. 6..1344 Wake-up duty cycle (Tsniff) – multiply 625us	800	YES

R/W	S232	Sniff parameter Min interval	see Note 2. 0..1342 Sniff offset (Dsniff) – multiply 625us Dsniff must be lower or equal to Tsniff-2	80	YES
R/W	S233	Sniff parameter Attempt	0..672 Number of slots listen by slave during wake-up Sniff parameter attempt must be lower than Tsniff/2	8	YES
R/W	S234	Sniff parameter Timeout	0..40 Number of additional slots listen by slave during wake-up	8	YES

The column “link disconnection if register value change” does not apply if the modification is done remotely (for a slave configured using the SPP CONFIG mode).

NOTE 1

when changing the serial link configuration (rate, parity, stop bit...), the answer is done using the old serial link format, the next command must be sent using the new serial format.

IMPORTANT : Firmware version dependant – Refer to Annexe 1 – Pg 22

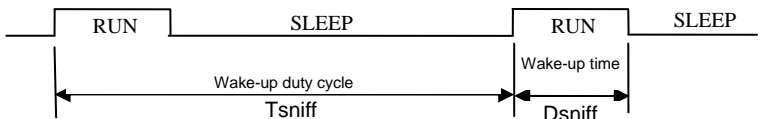
NOTE 2

Recommended exclusion zone around antenna

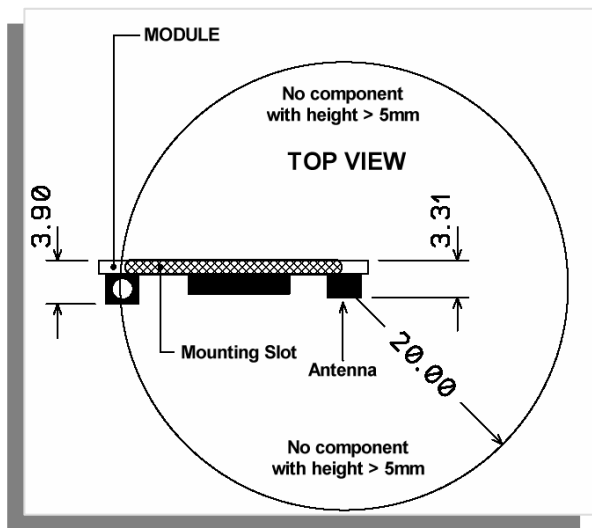

Specifications

Embedded profiles	GAP, SDAP, SPP, DUN
Link set-up and status	Through Hayes commands
Radio rough data rate	723 kbps Bluetooth radio rate bps (3Mbps on EDR mode)
UART programmable format	Serial rate from 9600 bps to 921 600 bps
UART TTL ports	TD – RD – RTS – CTS (& DTR-DSR-DCD-RI / DUN profile)
Operating-mode	Transparent
RF radiated power	20 dBm (100 mW – Class 1)
Sensitivity	Up to -87 dBm for 10 ⁻³ /PN9
Operating range (outdoor)	Integrated antenna : up to 150 m
Operating voltage	3 to 3.6 V
Waiting for connection consumption	3 mA
Connected consumption	6 mA
Burst transmission consumption (max)	300 mA (Better to use a 500 mA regulator)

Ref. 08-12-V5-pcy

Transmission consumption (typical value in file transfer)	50mA
Operating temperature	-20°C / +70°C
Dimensions	33 x 18 x 6 mm
Standards compliance	EN 300-328 / EN 301 489

References

ARF7456A : Bluetooth® Class 1 Module

ARF7504A : RS232 interface - RS232 Demo Kit

Annex 1 : Firmware and document updates

Firmware	Updates
ARF745XXB-V1.06	Firmware default data rate is now 9600 bps. Default data rate is 9600 bps and "Restore register default value – AT&F" gives data rate back to 9600 bps
ARF745XXA-V1.05	AT&RSSI introduction. Default data rate is set to 9600 bps but "Restore register default value – AT&F" will give data rate back to 115 kbps !!!
V1.03	DUN + SPP profile with auto-connect on DTR Default data rate is set to 9600 bps but "Restore register default value – AT&F" will give data rate back to 115 kbps !!!
V1.0	Original version Default data rate is set to 9600 bps but "Restore register default value – AT&F" will give data rate back to 115 kbps !!!

Document	Updates
V5.0	PCY – baudrate modifications
V4.0	Default data rate is now 9600 bps (Firmware version dependant!!!)
V3.1	AT&RSSI command + command/register additional information
V3.0	SPP + DUN quick start up
V2.0	CE Conformity correction + Detailed consumption & Picture addition
V1.0	Original version