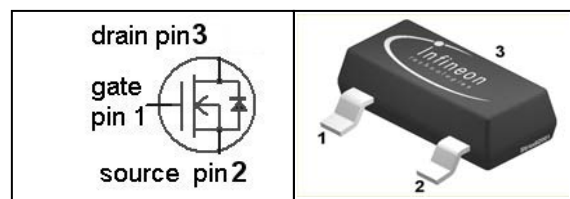

**SIPMOS<sup>®</sup> Small-Signal-Transistor**
**Features**

- N-channel
- Depletion mode
- dv/dt rated

**Product Summary**

$V_{DS}$	250	V
$R_{DS(on),max}$	30	$\Omega$
$I_{DSS,min}$	0.03	A

**SOT-23**

Type	Package	Ordering Code	Tape and Reel Information	Marking
BSS139	SOT-23	Q62702-S612	E6327: 3000 pcs/reel	STs

**Maximum ratings, at  $T_j=25\text{ }^\circ\text{C}$ , unless otherwise specified**

Parameter	Symbol	Conditions	Value	Unit
Continuous drain current	$I_D$	$T_A=25\text{ }^\circ\text{C}$	0.10	A
		$T_A=70\text{ }^\circ\text{C}$	0.08	
Pulsed drain current	$I_{D,pulse}$	$T_A=25\text{ }^\circ\text{C}$	0.4	
Reverse diode dv/dt	dv/dt	$I_D=0.1\text{ A}$ , $V_{DS}=200\text{ V}$ , $di/dt=200\text{ A}/\mu\text{s}$ , $T_{j,max}=150\text{ }^\circ\text{C}$	6	kV/ $\mu\text{s}$
Gate source voltage	$V_{GS}$		$\pm 20$	V
ESD sensitivity (HBM) as per MIL-STD 883			Class 1	
Power dissipation	$P_{tot}$	$T_A=25\text{ }^\circ\text{C}$	0.36	W
Operating and storage temperature	$T_j, T_{stg}$		-55 ... 150	$^\circ\text{C}$
IEC climatic category; DIN IEC 68-1			55/150/56	

Parameter	Symbol	Conditions	Values			Unit
			min.	typ.	max.	

**Thermal characteristics**

Thermal resistance, junction - minimal footprint	$R_{thJA}$		-	-	350	K/W
--	------------	--	---	---	-----	-----

**Electrical characteristics, at  $T_j=25\text{ °C}$ , unless otherwise specified**
**Static characteristics**

Drain-source breakdown voltage	$V_{(BR)DSS}$	$V_{GS}=-3\text{ V}, I_D=250\text{ }\mu\text{A}$	250	-	-	V
Gate threshold voltage	$V_{GS(th)}$	$V_{DS}=3\text{ V}, I_D=56\text{ }\mu\text{A}$	-2.1	-1.4	-1	
Drain-source leakage current	$I_{D(off)}$	$V_{DS}=250\text{ V}, V_{GS}=-3\text{ V}, T_j=25\text{ °C}$	-	-	0.1	$\mu\text{A}$
		$V_{DS}=250\text{ V}, V_{GS}=-3\text{ V}, T_j=125\text{ °C}$	-	-	10	
Gate-source leakage current	$I_{GSS}$	$V_{GS}=20\text{ V}, V_{DS}=0\text{ V}$	-	-	10	nA
Saturated drain current	$I_{DSS}$	$V_{GS}=0\text{ V}, V_{DS}=10\text{ V}$	30	-	-	mA
Drain-source on-state resistance	$R_{DS(on)}$	$V_{GS}=0\text{ V}, I_D=15\text{ mA}$	-	12.5	30	$\Omega$
		$V_{GS}=10\text{ V}, I_D=0.1\text{ A}$	-	7.8	14.0	
Transconductance	$g_{fs}$	$ V_{DS} >2 I_D R_{DS(on)max}, I_D=0.08\text{ A}$	0.06	0.13	-	S

Parameter	Symbol	Conditions	Values			Unit
			min.	typ.	max.	

**Dynamic characteristics**

Input capacitance	$C_{iss}$	$V_{GS}=-3\text{ V}, V_{DS}=25\text{ V},$ $f=1\text{ MHz}$	-	60	76	pF
Output capacitance	$C_{oss}$		-	6.7	8.4	
Reverse transfer capacitance	$C_{rss}$		-	2.6	3.3	
Turn-on delay time	$t_{d(on)}$	$V_{DD}=125\text{ V},$ $V_{GS}=-3\dots 5\text{ V},$ $I_D=0.04\text{ A}, R_G=6\ \Omega$	-	5.8	8.7	ns
Rise time	$t_r$		-	5.4	8.1	
Turn-off delay time	$t_{d(off)}$		-	29	43	
Fall time	$t_f$		-	182	273	

**Gate Charge Characteristics**

Gate to source charge	$Q_{gs}$	$V_{DD}=200\text{ V},$ $I_D=0.04\text{ A},$ $V_{GS}=-3\text{ to }5\text{ V}$	-	0.14	0.21	nC
Gate to drain charge	$Q_{gd}$		-	1.3	2.0	
Gate charge total	$Q_g$		-	2.3	3.5	
Gate plateau voltage	$V_{plateau}$		-	-0.28	-	V

**Reverse Diode**

Diode continuous forward current	$I_S$	$T_A=25\text{ }^\circ\text{C}$	-	-	0.10	A
Diode pulse current	$I_{S,pulse}$		-	-	0.4	
Diode forward voltage	$V_{SD}$	$V_{GS}=-3\text{ V}, I_F=0.1\text{ A},$ $T_J=25\text{ }^\circ\text{C}$	-	0.81	1.2	V
Reverse recovery time	$t_{rr}$	$V_R=50\text{ V}, I_F=0.04\text{ A},$ $di_F/dt=100\text{ A}/\mu\text{s}$	-	8.6	12.9	ns
Reverse recovery charge	$Q_{rr}$		-	2.1	3.1	nC

**1 Power dissipation**

$P_{tot}=f(T_A)$

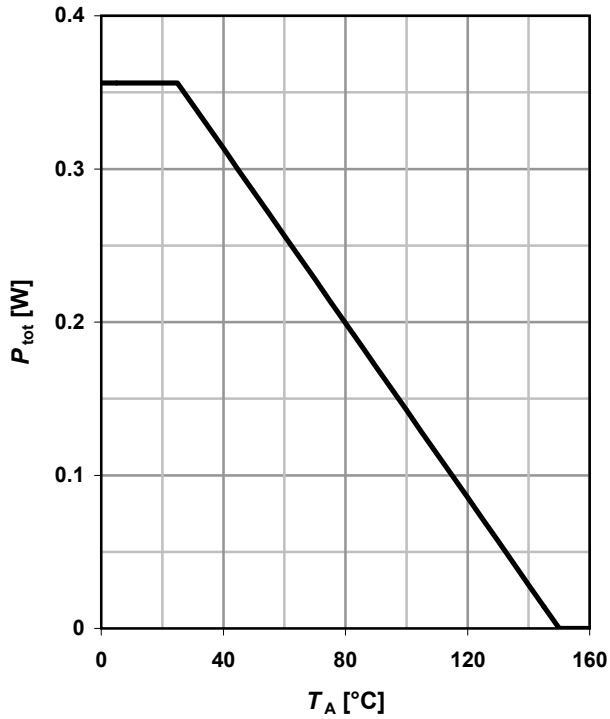

**2 Drain current**

$I_D=f(T_A); V_{GS}\geq 10\text{ V}$

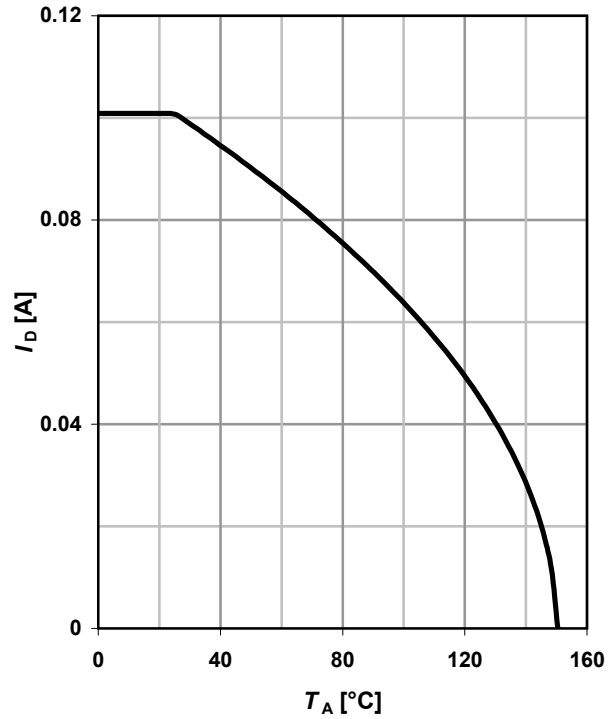

**3 Safe operation area**

$I_D=f(V_{DS}); T_A=25\text{ °C}; D=0$

parameter:  $t_p$

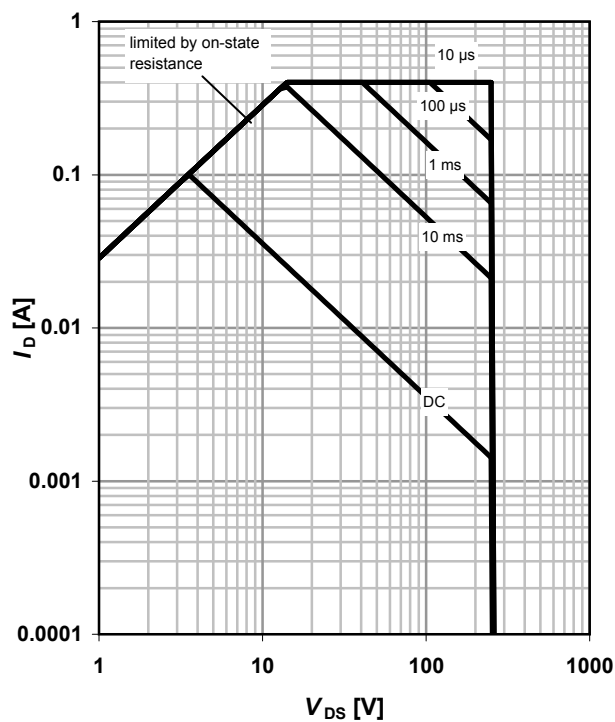

**4 Max. transient thermal impedance**

$Z_{thJA}=f(t_p)$

parameter:  $D=t_p/T$

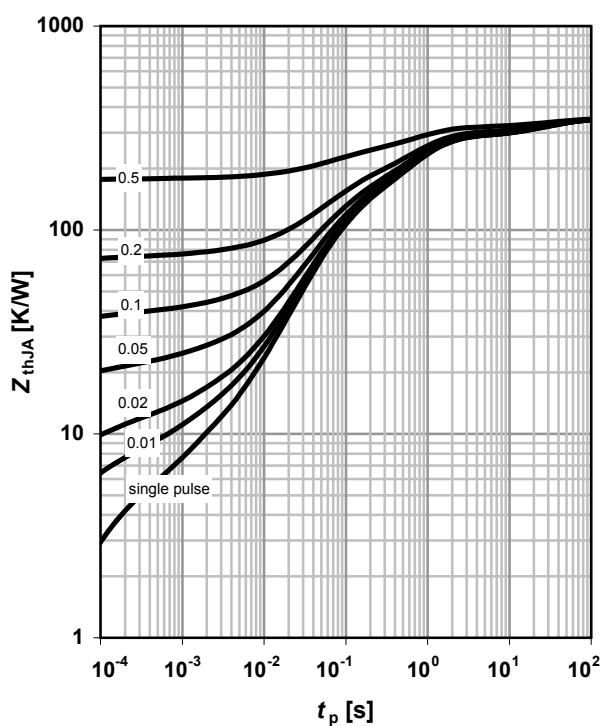

**5 Typ. output characteristics**

$I_D = f(V_{DS}); T_j = 25\text{ }^\circ\text{C}$

parameter:  $V_{GS}$

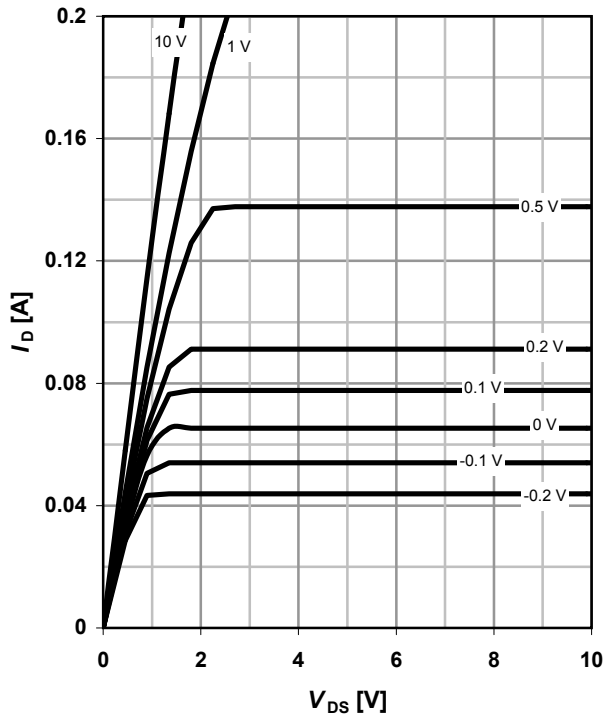

**6 Typ. drain-source on resistance**

$R_{DS(on)} = f(I_D); T_j = 25\text{ }^\circ\text{C}$

parameter:  $V_{GS}$

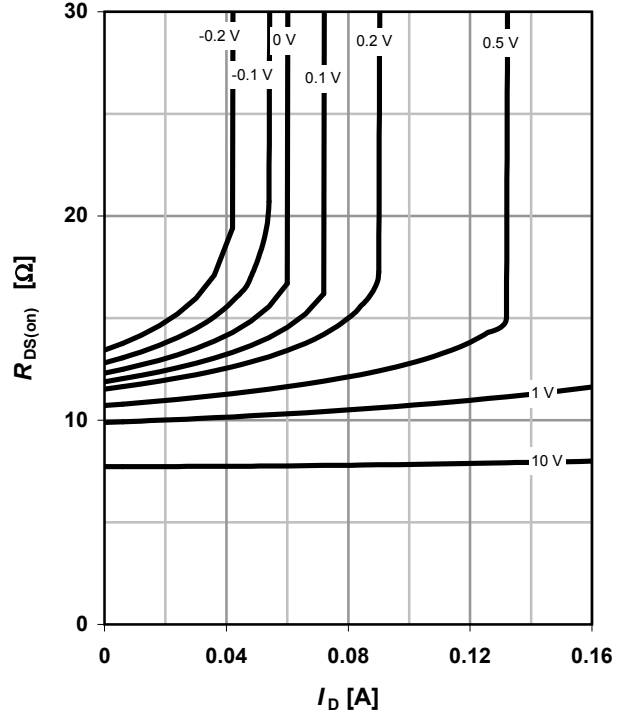

**7 Typ. transfer characteristics**

$I_D = f(V_{GS}); |V_{DS}| > 2|I_D|R_{DS(on)max}$

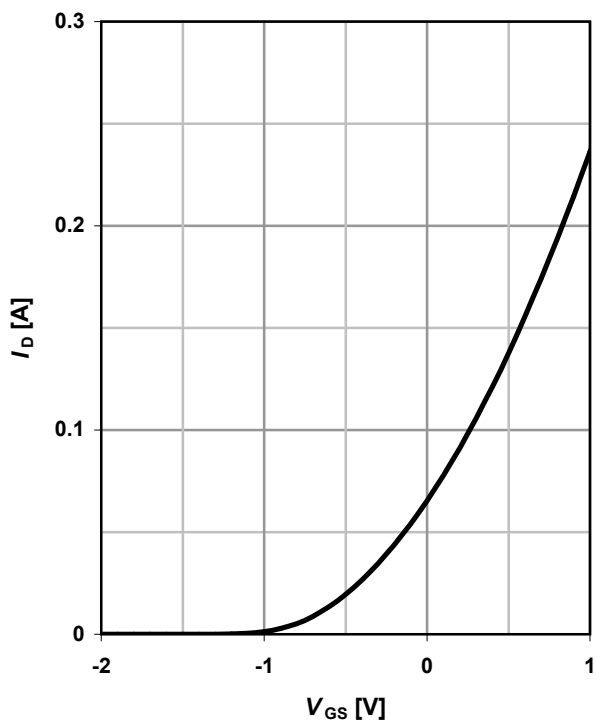

**8 Typ. forward transconductance**

$g_{fs} = f(I_D); T_j = 25\text{ }^\circ\text{C}$

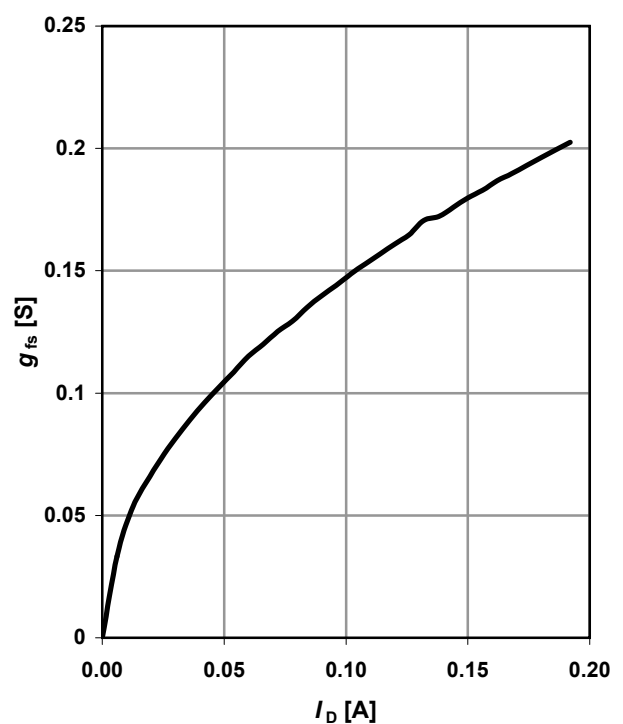

**9 Drain-source on-state resistance**

$R_{DS(on)}=f(T_j); I_D=0.015\text{ A}; V_{GS}=0\text{ V}$

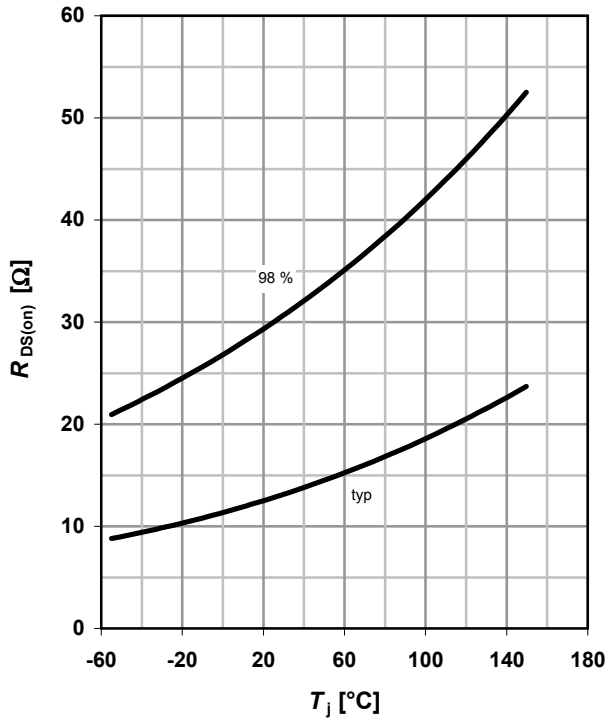

**10 Typ. gate threshold voltage**

$V_{GS(th)}=f(T_j); V_{DS}=3\text{ V}; I_D=56\text{ }\mu\text{A}$

parameter:  $I_D$

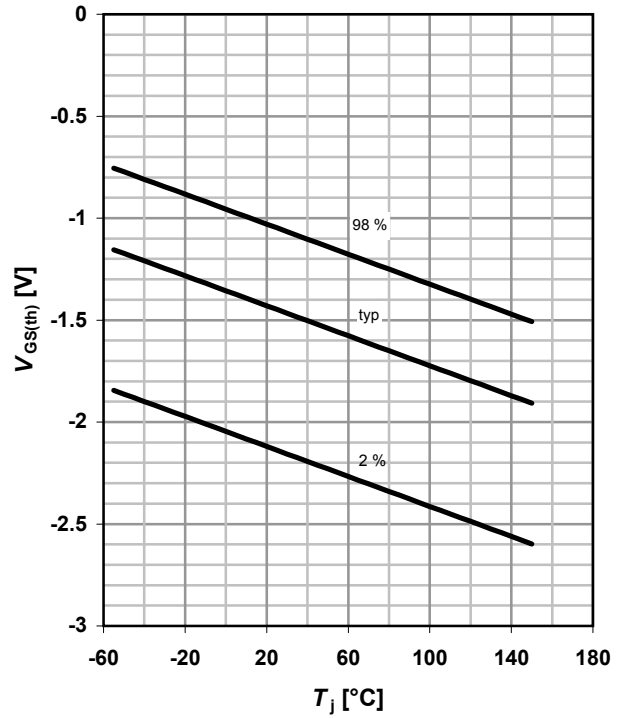

**11 Typ. Capacitances**

$C=f(V_{DS}); V_{GS}=-3\text{ V}; f=1\text{ MHz}$

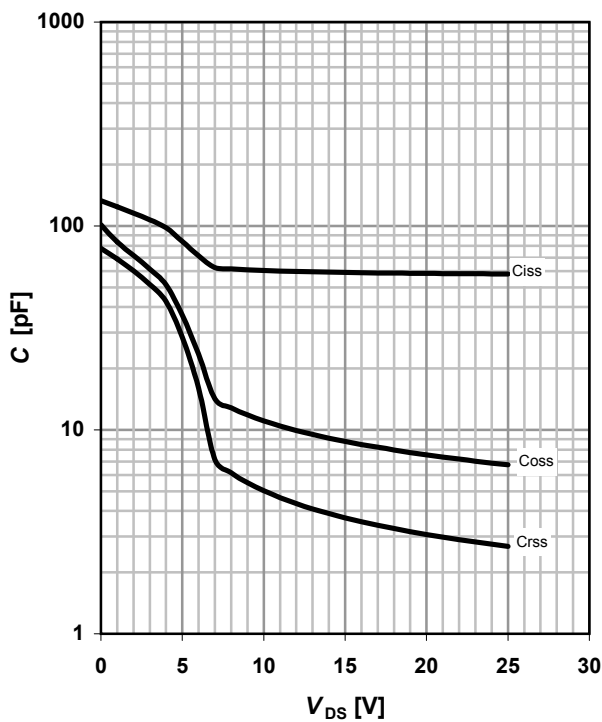

**12 Forward characteristics of reverse diode**

$I_F=f(V_{SD})$

parameter:  $T_j$

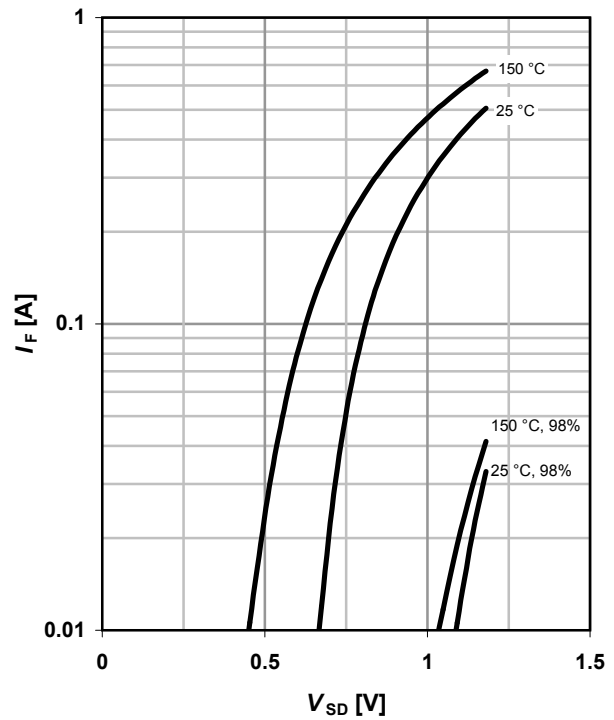

**14 Typ. gate charge**

$V_{GS}=f(Q_{gate}); I_D=0.04\text{ A pulsed}$

parameter:  $V_{DD}$

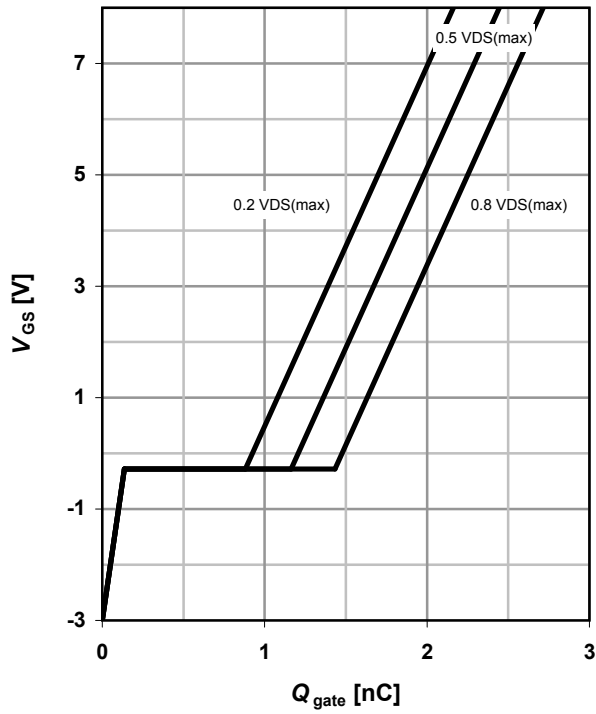

**15 Drain-source breakdown voltage**

$V_{BR(DSS)}=f(T_j); I_D=250\ \mu\text{A}$

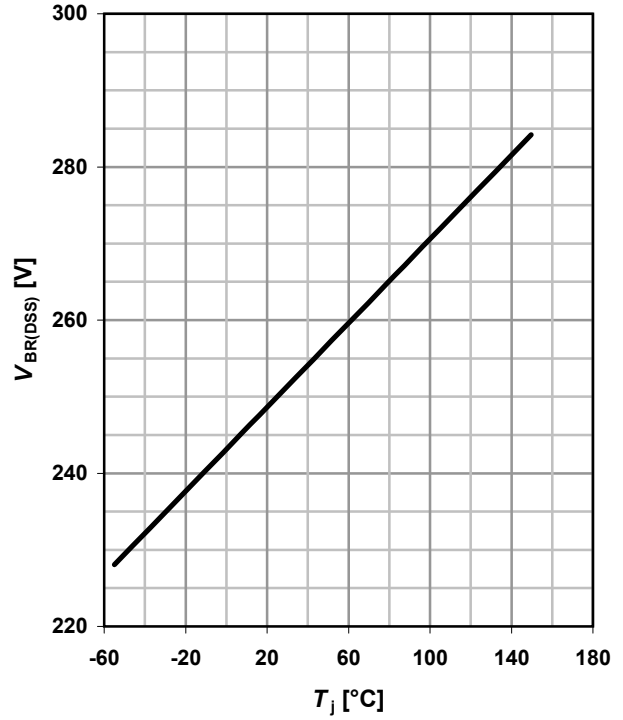

Package Outline:

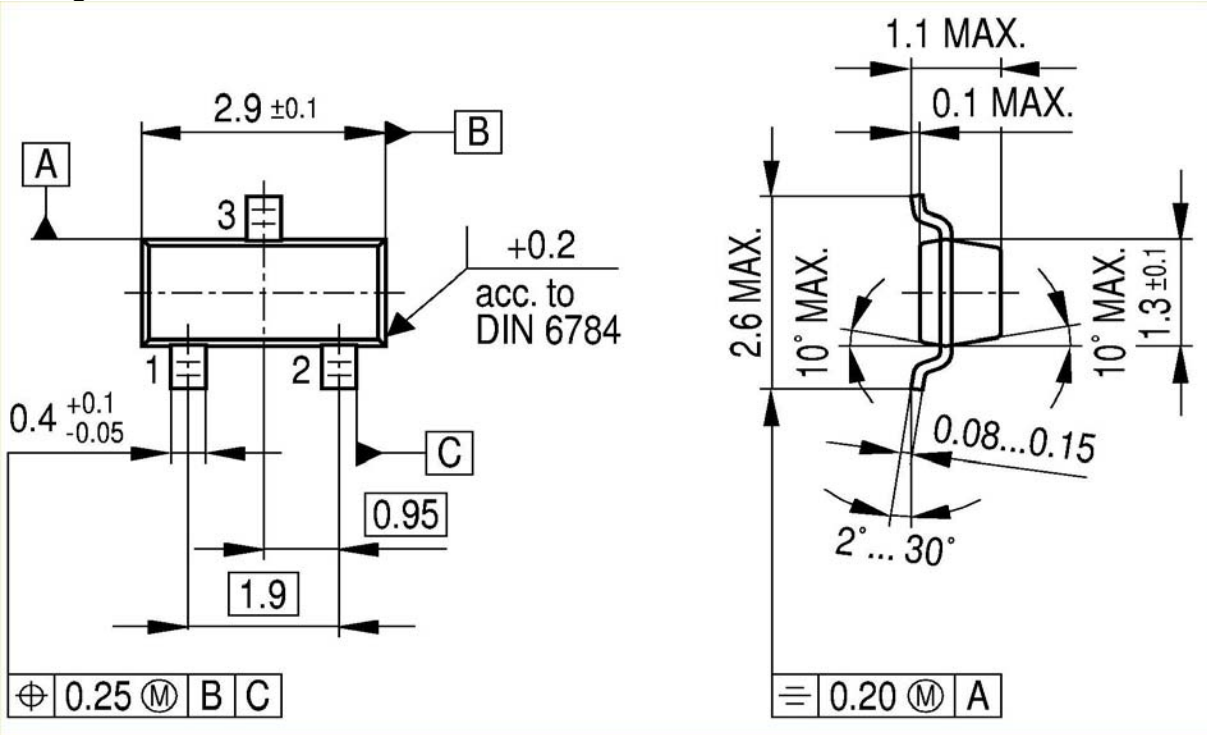

Footprint:

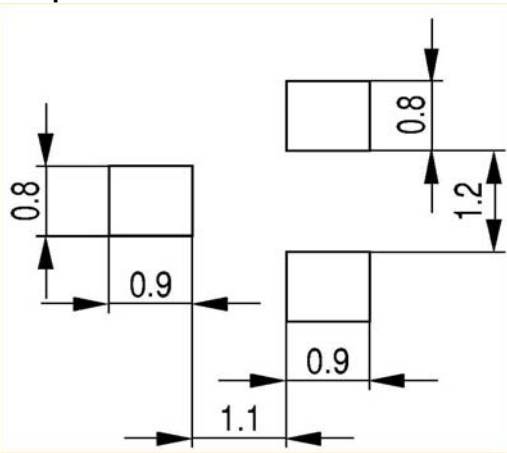

Packaging:

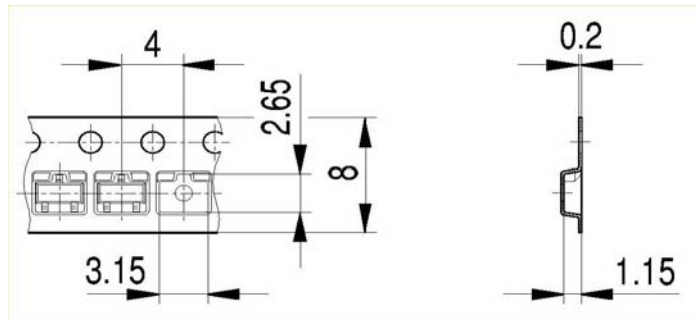



**Published by**  
**Infineon Technologies AG**  
**Bereich Kommunikation**  
**St.-Martin-Straße 53**  
**D-81541 München**  
**© Infineon Technologies AG 1999**  
**All Rights Reserved.**

**Attention please!**

The information herein is given to describe certain components and shall not be considered as warranted characteristics.

Terms of delivery and rights to technical change reserved.

We hereby disclaim any and all warranties, including but not limited to warranties of non-infringement, regarding circuits, descriptions and charts started herein.

Infineon Technologies is an approved CECC manufacturer.

**Information**

For further information on technology, delivery terms and conditions and prices, please contact your nearest Infineon Technologies office in Germany or our Infineon Technologies representatives worldwide (see address list).

**Warnings**

Due to technical requirements, components may contain dangerous substances.  
For information on the types in question, please contact your nearest Infineon Technologies office.

Infineon Technologies' components may only be used in life-support devices or systems with the expressed written approval of Infineon Technologies if a failure of such components can reasonably be expected to cause the failure of that life-support device or system, or to affect the safety or effectiveness of that device or system. Life support devices or systems are intended to be implanted in the human body, or to support and/or maintain and sustain and/or protect human life. If they fail, it is reasonable to assume that the health of the user or other persons may be endangered.