

Agilent ADA-4643

Silicon Bipolar Darlington Amplifier

Data Sheet

Description

Agilent Technologies' ADA-4643 is an economical, easy-to-use, general purpose silicon bipolar RFIC gain block amplifiers housed in a 4-lead SC-70 (SOT-343) surface mount plastic package which requires only half the board space of a SOT-143 package.

The Darlington feedback structure provides inherent broad bandwidth performance, resulting in useful operating frequency up to 2.5 GHz. This is an ideal device for small-signal gain cascades or IF amplification.

ADA-4643 is fabricated using Agilent's HP25 silicon bipolar process, which employs a double-diffused single polysilicon process with self-aligned submicron emitter geometry. The process is capable of simultaneous high f_T and high NPN breakdown (25 GHz f_T at 6V BVCEO). The process utilizes industry standard device oxide isolation technologies and submicron aluminum multilayer interconnect to achieve superior performance, high uniformity, and proven reliability.

Surface Mount Package SOT-343

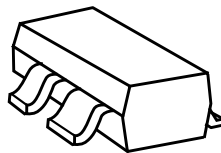

Pin Connections and Package Marking

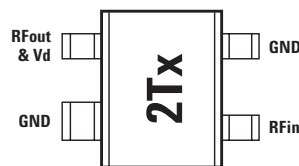

Note:
Top View. Package marking provides orientation and identification.

"2T" = Device Code
"x" = Date code character
identifies month of manufacture.

Typical Biasing Configuration

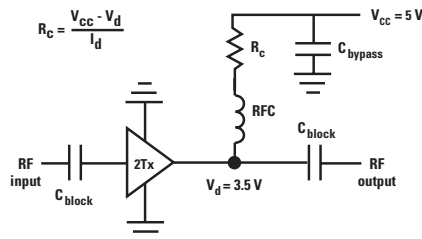

Features

- Small Signal gain amplifier
- Operating frequency DC – 2.5 GHz
- Unconditionally stable
- 50 Ohms input & output
- Flat, Broadband Frequency Response up to 1 GHz
- Operating Current: 20 to 60 mA
- Industry standard SOT-343 package

Specifications

900 MHz, 3.5V, 35 mA (typ.)

- 17 dB associated gain
- 13.4 dBm P_{1dB}
- 28.3 dBm OIP_3
- 4 dB noise figure
- VSWR < 2.2 throughput operating frequency
- Single supply, typical $I_d = 35$ mA

Applications

- Cellular/PCS/WLL base stations
- Wireless data/WLAN
- Fiber-optic systems
- ISM



ADA-4643 Absolute Maximum Ratings^[1]

| Symbol | Parameter | Units | Absolute Maximum |
|----------------|--|-------|------------------|
| I_d | Device Current | mA | 70 |
| P_{diss} | Total Power Dissipation ^[2] | mW | 270 |
| $P_{in\ max.}$ | RF Input Power | dBm | 18 |
| T_j | Channel Temperature | °C | 150 |
| T_{STG} | Storage Temperature | °C | -65 to 150 |
| θ_{jc} | Thermal Resistance ^[3] | °C/W | 152 |

Notes:

1. Operation of this device above any one of these parameters may cause permanent damage.
2. Ground lead temperature is 25°C. Derate 6.6 mW/°C for TL >109°C.
3. Junction-to-case thermal resistance measured using 150°C Liquid Crystal Measurement method.

ADA-4643 Electrical Specifications

$T_A = 25^\circ\text{C}$, $Z_0 = 50\Omega$, $P_{in} = -25\ \text{dBm}$, $I_d = 35\ \text{mA}$ (unless specified otherwise)

| Symbol | Parameter and Test Condition: $I_d = 35\ \text{mA}$, $Z_0 = 50\Omega$ | Frequency | Units | Min. | Typ. | Max. | Std. Dev. |
|--------------|---|--|-------|------|--------------|------|-------------|
| V_d | Device Voltage $I_d = 35\ \text{mA}$ | | V | 3.2 | 3.5 | 3.9 | |
| G_p | Power Gain ($ S_{21} ^2$) | 100 MHz 900 MHz ^[1,2] | dB | 15.5 | 17.5 17.0 | 18.5 | |
| ΔG_p | Gain Flatness | 100 to 900 MHz 0.1 to 2 GHz | dB | | 0.5 1.8 | | |
| F_{3dB} | 3 dB Bandwidth | | GHz | | 3.2 | | |
| $VSMR_{in}$ | Input Voltage Standing Wave Ratio | 0.1 to 6 GHz | | | 2.0:1 | | |
| $VSMR_{out}$ | Output Voltage Standing Wave Ratio | 0.1 to 6 GHz | | | 1.6:1 | | |
| NF | 50Ω Noise Figure | 100 MHz 900 MHz ^[1,2] | dB | | 3.9 4.0 | | 0.07 0.1 |
| P_{1dB} | Output Power at 1dB Gain Compression | 100 MHz 900 MHz ^[1,2] | dBm | | 14.7 13.4 | | |
| OIP_3 | Output 3 rd Order Intercept Point | 100 MHz ^[3] 900 MHz ^[1,2,3] | dBm | | 29.0 28.3 | | |
| DV/dT | Device Voltage Temperature Coefficient | | mV/°C | | -5.3 | | |

Notes:

1. Typical value determined from a sample size of 500 parts from 3 wafers.
2. Measurement obtained using production test board described in the block diagram below.
3. I) 900 MHz OIP_3 test condition: F1 = 900 MHz, F2 = 905 MHz and $P_{in} = -25\ \text{dBm}$ per tone.
II) 100 MHz OIP_3 test condition: F1 = 100 MHz, F2 = 105 MHz and $P_{in} = -25\ \text{dBm}$ per tone.

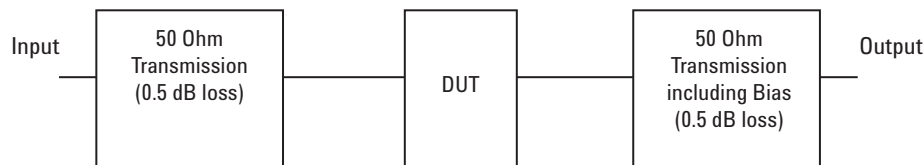

Block diagram of 900 MHz production test board used for V_d , Gain, P_{1dB} , OIP_3 , and NF measurements. Circuit losses have been de-embedded from actual measurements.

Product Consistency Distribution Charts at 900 MHz, $I_d = 35$ mA

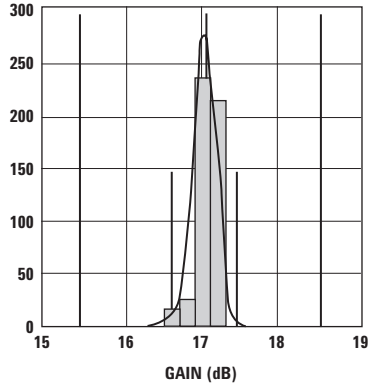

Figure 1. Gain distribution @ 35 mA.
LSL = 15.5, Nominal = 17, USL = 18.5

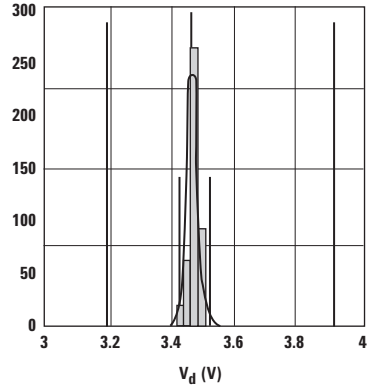

Figure 2. V_d distribution @ 35 mA.
LSL = 3.2, Nominal = 3.5, USL = 3.9

Notes:

1. Statistics distribution determined from a sample size of 500 parts taken from 3 different wafers.
2. Future wafers allocated to this product may have typical values anywhere between the minimum and maximum specification limits.

ADA-4643 Typical Performance Curves (at 25°C, unless specified otherwise)

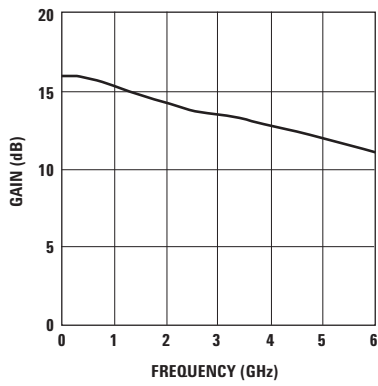

Figure 3. Gain vs. Frequency at $I_d = 35$ mA.

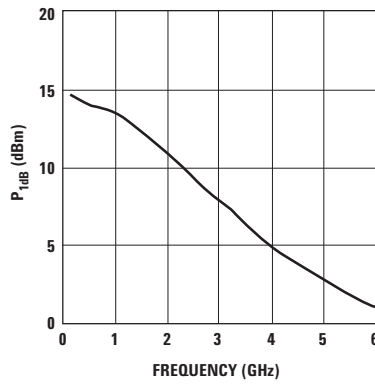

Figure 4. P_{1dB} vs. Frequency at $I_d = 35$ mA.

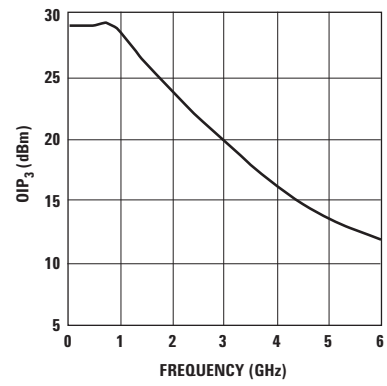

Figure 5. OIP_3 vs. Frequency at $I_d = 35$ mA.

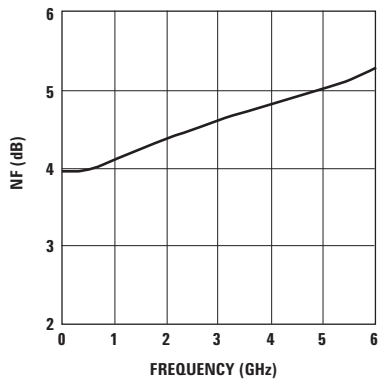

Figure 6. NF vs. Frequency at $I_d = 35$ mA.

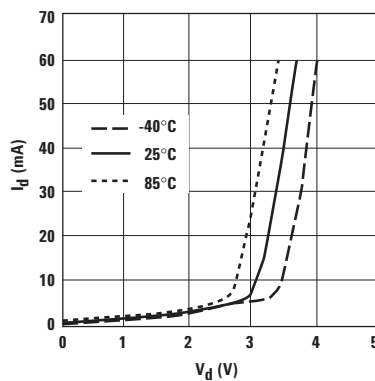

Figure 7. I_d vs. V_d and Temperature.

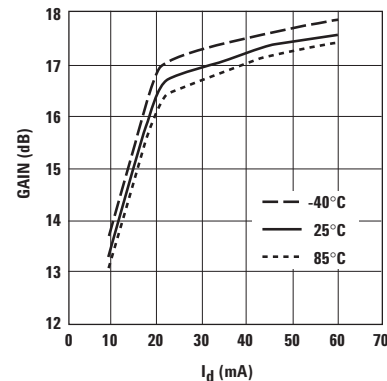

Figure 8. Gain vs. I_d and Temperature at 900 MHz.

ADA-4643 Typical Performance Curves (at 25°C, unless specified otherwise), continued

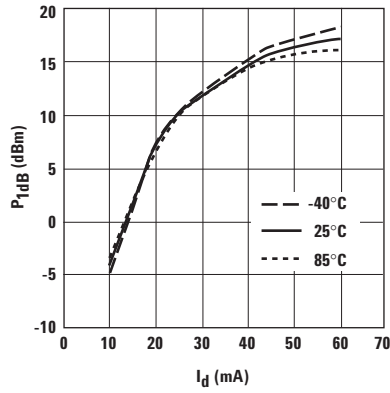

Figure 9. P_{1dB} vs. I_d and Temperature at 900 MHz.

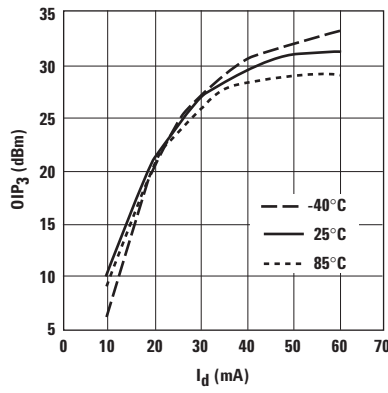

Figure 10. OIP₃ vs. I_d and Temperature at 900 MHz.

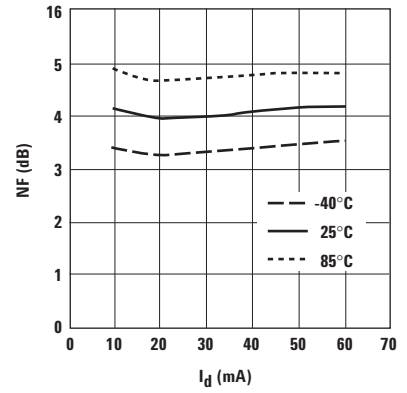

Figure 11. NF vs. I_d and Temperature at 900 MHz.

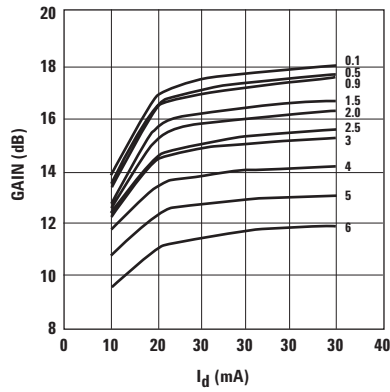

Figure 12. Gain vs. I_d and Frequency (GHz).

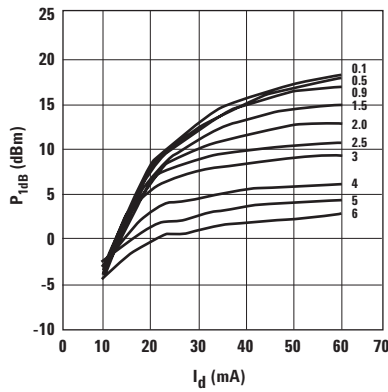

Figure 13. P_{1dB} vs. I_d and Frequency (GHz).

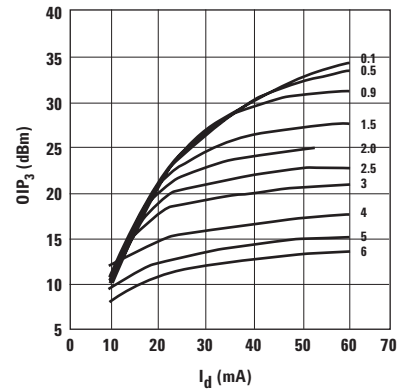

Figure 14. OIP₃ vs. I_d and Frequency (GHz).

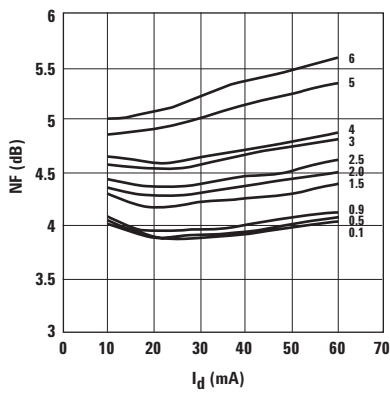

Figure 15. NF vs. I_d and Frequency (GHz).

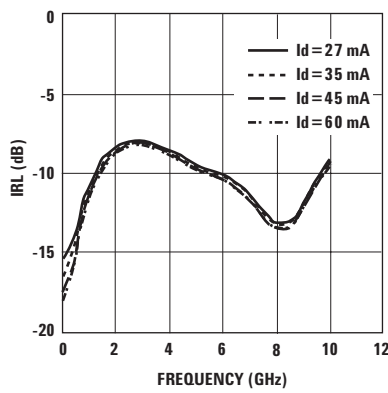

Figure 16. Input Return Loss vs. I_d and Frequency (GHz).

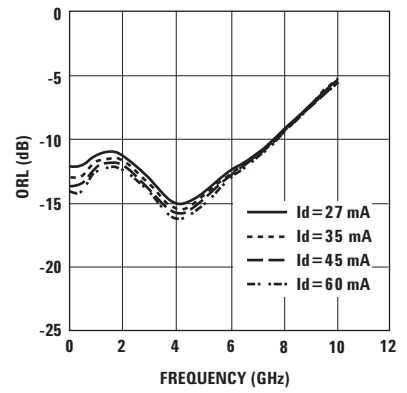

Figure 17. Output Return Loss vs. I_d and Frequency (GHz).

ADA-4643 Typical Scattering Parameters, $T_A = 25^\circ\text{C}$, $I_d = 27\text{ mA}$

| Freq. GHz | S ₁₁ | | | S ₂₁ | | | S ₁₂ | | S ₂₂ | | K |
|--------------|-----------------|--------|-------|-----------------|--------|-------|-----------------|-------|-----------------|-----|---|
| | Mag. | Ang. | dB | Mag. | Ang. | Mag. | Ang. | Mag. | Ang. | | |
| 0.1 | 0.172 | 1.1 | 17.2 | 7.246 | 175.9 | 0.093 | -0.8 | 0.245 | -4.1 | 1.1 | |
| 0.5 | 0.202 | 10 | 17.04 | 7.113 | 160.2 | 0.091 | -4.5 | 0.245 | -12.6 | 1.1 | |
| 0.9 | 0.277 | 12.3 | 16.67 | 6.814 | 144.7 | 0.088 | -7.4 | 0.269 | -20.4 | 1.1 | |
| 1.0 | 0.286 | 9.9 | 16.56 | 6.726 | 141.1 | 0.087 | -7.9 | 0.274 | -23.1 | 1.1 | |
| 1.5 | 0.349 | -2.8 | 15.98 | 6.292 | 124.2 | 0.083 | -9.3 | 0.28 | -37.6 | 1.1 | |
| 1.9 | 0.375 | -11.3 | 15.54 | 5.984 | 111.4 | 0.080 | -9.5 | 0.273 | -48.9 | 1.2 | |
| 2.0 | 0.382 | -13.8 | 15.44 | 5.918 | 108.3 | 0.08 | -9.5 | 0.271 | -51.7 | 1.2 | |
| 2.5 | 0.397 | -24.2 | 14.93 | 5.581 | 93.2 | 0.078 | -8.9 | 0.249 | -65.8 | 1.2 | |
| 3.0 | 0.402 | -34.7 | 14.47 | 5.29 | 78.6 | 0.078 | -7.8 | 0.22 | -81.7 | 1.3 | |
| 3.5 | 0.394 | -46 | 14.02 | 5.021 | 64.2 | 0.079 | -6.6 | 0.192 | -100.9 | 1.3 | |
| 4.0 | 0.378 | -58.7 | 13.58 | 4.775 | 50 | 0.082 | -5.4 | 0.176 | -123.8 | 1.3 | |
| 4.5 | 0.361 | -73.1 | 13.16 | 4.55 | 35.9 | 0.087 | -4.6 | 0.179 | -148.6 | 1.3 | |
| 5.0 | 0.340 | -89.3 | 12.64 | 4.284 | 21.9 | 0.094 | -4.9 | 0.191 | -169.9 | 1.3 | |
| 5.5 | 0.328 | -107.1 | 12.15 | 4.05 | 8.3 | 0.102 | -5.9 | 0.212 | 173.3 | 1.2 | |
| 6.0 | 0.318 | -124.8 | 11.6 | 3.803 | -5.4 | 0.112 | -8.3 | 0.233 | 158.2 | 1.2 | |
| 6.5 | 0.299 | -141.1 | 11.09 | 3.584 | -18.6 | 0.124 | -11.5 | 0.25 | 141.6 | 1.1 | |
| 7.0 | 0.274 | -159.7 | 10.56 | 3.371 | -32 | 0.138 | -16.5 | 0.27 | 123 | 1.1 | |
| 7.5 | 0.243 | 177.3 | 9.96 | 3.149 | -45.6 | 0.150 | -22.8 | 0.3 | 103.6 | 1.1 | |
| 8.0 | 0.222 | 148.7 | 9.29 | 2.914 | -59.1 | 0.161 | -30 | 0.337 | 84.8 | 1.1 | |
| 8.5 | 0.226 | 119.9 | 8.41 | 2.632 | -71.8 | 0.168 | -36.7 | 0.381 | 70.1 | 1.1 | |
| 9.0 | 0.26 | 95.4 | 7.62 | 2.406 | -83.7 | 0.177 | -43 | 0.429 | 58.4 | 1.1 | |
| 9.5 | 0.305 | 75.2 | 6.67 | 2.155 | -96.1 | 0.187 | -49.9 | 0.481 | 48.4 | 1.1 | |
| 10.0 | 0.356 | 60.1 | 5.82 | 1.954 | -107.1 | 0.195 | -57.3 | 0.529 | 39.7 | 1 | |

Notes:

1. S-parameters are measured on a microstrip line made on 0.025 inch thick alumina carrier. The input reference plane is at the end of the input lead. The output reference plane is at the end of the output lead.

ADA-4643 Typical Scattering Parameters, $T_A = 25^\circ\text{C}$, $I_d = 35\text{ mA}$

| Freq. GHz | S_{11} | | dB | S_{21} | | S_{12} | | S_{22} | | K |
|--------------|----------|--------|-------|----------|--------|----------|-------|----------|--------|-----|
| | Mag. | Ang. | | Mag. | Ang. | Mag. | Ang. | Mag. | Ang. | |
| 0.1 | 0.151 | 1.6 | 17.51 | 7.504 | 175.9 | 0.091 | -0.8 | 0.223 | -4.1 | 1.1 |
| 0.5 | 0.185 | 13.1 | 17.35 | 7.367 | 160.1 | 0.09 | -4.2 | 0.224 | -11.7 | 1.1 |
| 0.9 | 0.265 | 14.9 | 16.98 | 7.06 | 144.6 | 0.087 | -7 | 0.251 | -19 | 1.1 |
| 1.0 | 0.272 | 12.4 | 16.86 | 6.97 | 140.9 | 0.086 | -7.5 | 0.256 | -21.7 | 1.1 |
| 1.5 | 0.340 | -0.7 | 16.27 | 6.511 | 123.9 | 0.082 | -8.8 | 0.264 | -36.2 | 1.1 |
| 1.9 | 0.367 | -9.5 | 15.82 | 6.178 | 111 | 0.080 | -9.1 | 0.259 | -47.6 | 1.2 |
| 2.0 | 0.373 | -12.1 | 15.72 | 6.107 | 108 | 0.079 | -9.1 | 0.256 | -50.3 | 1.2 |
| 2.5 | 0.39 | -22.7 | 15.19 | 5.745 | 92.8 | 0.078 | -8.5 | 0.236 | -64.4 | 1.2 |
| 3.0 | 0.395 | -33 | 14.71 | 5.436 | 78.3 | 0.077 | -7.3 | 0.209 | -80.4 | 1.3 |
| 3.5 | 0.387 | -44.3 | 14.23 | 5.149 | 63.9 | 0.079 | -6 | 0.181 | -99.9 | 1.3 |
| 4.0 | 0.370 | -57.4 | 13.79 | 4.89 | 49.9 | 0.082 | -4.8 | 0.166 | -123.4 | 1.3 |
| 4.5 | 0.353 | -71.6 | 13.36 | 4.657 | 35.9 | 0.087 | -3.9 | 0.17 | -148.9 | 1.3 |
| 5.0 | 0.332 | -87.7 | 12.84 | 4.383 | 21.9 | 0.093 | -4.2 | 0.185 | -170.6 | 1.2 |
| 5.5 | 0.319 | -106 | 12.34 | 4.141 | 8.3 | 0.102 | -5.1 | 0.207 | 172.5 | 1.2 |
| 6.0 | 0.310 | -123.6 | 11.8 | 3.889 | -5.4 | 0.112 | -7.5 | 0.23 | 157.5 | 1.2 |
| 6.5 | 0.293 | -140.2 | 11.28 | 3.666 | -18.6 | 0.124 | -10.8 | 0.248 | 140.9 | 1.1 |
| 7.0 | 0.266 | -158.8 | 10.75 | 3.449 | -32 | 0.138 | -15.8 | 0.27 | 122.3 | 1.1 |
| 7.5 | 0.238 | 177.8 | 10.15 | 3.219 | -45.5 | 0.151 | -22.2 | 0.301 | 103 | 1.1 |
| 8.0 | 0.217 | 148.5 | 9.48 | 2.979 | -59 | 0.161 | -29.3 | 0.34 | 84.3 | 1.1 |
| 8.5 | 0.222 | 119.5 | 8.62 | 2.697 | -71.7 | 0.169 | -36.1 | 0.385 | 69.6 | 1.1 |
| 9.0 | 0.256 | 95 | 7.81 | 2.458 | -83.4 | 0.178 | -42.5 | 0.434 | 57.9 | 1.1 |
| 9.5 | 0.300 | 74.9 | 6.88 | 2.208 | -95.8 | 0.188 | -49.5 | 0.486 | 47.9 | 1 |
| 10.0 | 0.357 | 59.1 | 6.01 | 1.996 | -107.2 | 0.196 | -56.9 | 0.534 | 39.2 | 1 |

Notes:

1. S-parameters are measured on a microstrip line made on 0.025 inch thick alumina carrier. The input reference plane is at the end of the input lead. The output reference plane is at the end of the output lead.

ADA-4643 Typical Scattering Parameters, $T_A = 25^\circ\text{C}$, $I_d = 45\text{ mA}$

| Freq. GHz | S_{11} | | | S_{21} | | | S_{12} | | S_{22} | | K |
|--------------|----------|--------|-------|----------|--------|-------|----------|-------|----------|-----|---|
| | Mag. | Ang. | dB | Mag. | Ang. | Mag. | Ang. | Mag. | Ang. | | |
| 0.1 | 0.137 | 2.4 | 17.72 | 7.691 | 175.9 | 0.09 | -0.7 | 0.207 | -4 | 1.1 | |
| 0.5 | 0.174 | 15.3 | 17.56 | 7.547 | 160 | 0.089 | -4 | 0.209 | -10.9 | 1.1 | |
| 0.9 | 0.257 | 17.4 | 17.19 | 7.234 | 144.5 | 0.086 | -6.8 | 0.238 | -17.6 | 1.1 | |
| 1.0 | 0.267 | 14.7 | 17.08 | 7.144 | 140.8 | 0.085 | -7.2 | 0.243 | -20.3 | 1.1 | |
| 1.5 | 0.334 | 0.7 | 16.47 | 6.664 | 123.7 | 0.081 | -8.5 | 0.253 | -34.8 | 1.1 | |
| 1.9 | 0.36 | -8.4 | 16.01 | 6.317 | 110.7 | 0.079 | -8.7 | 0.249 | -46.1 | 1.1 | |
| 2.0 | 0.367 | -10.9 | 15.91 | 6.241 | 107.7 | 0.079 | -8.7 | 0.247 | -48.9 | 1.2 | |
| 2.5 | 0.386 | -21.6 | 15.36 | 5.862 | 92.5 | 0.077 | -8.1 | 0.227 | -62.9 | 1.2 | |
| 3.0 | 0.39 | -32.1 | 14.86 | 5.534 | 78 | 0.077 | -7 | 0.201 | -78.9 | 1.2 | |
| 3.5 | 0.382 | -43.4 | 14.38 | 5.237 | 63.6 | 0.078 | -5.7 | 0.174 | -98.4 | 1.3 | |
| 4.0 | 0.365 | -56.4 | 13.93 | 4.971 | 49.7 | 0.081 | -4.5 | 0.159 | -122.3 | 1.3 | |
| 4.5 | 0.348 | -70.8 | 13.5 | 4.732 | 35.7 | 0.086 | -3.6 | 0.164 | -148.3 | 1.3 | |
| 5.0 | 0.327 | -86.8 | 12.97 | 4.45 | 21.7 | 0.093 | -3.9 | 0.179 | -170.4 | 1.2 | |
| 5.5 | 0.314 | -105.1 | 12.48 | 4.205 | 8.2 | 0.101 | -4.8 | 0.202 | 172.6 | 1.2 | |
| 6.0 | 0.304 | -122.8 | 11.93 | 3.947 | -5.5 | 0.112 | -7.1 | 0.226 | 157.6 | 1.2 | |
| 6.5 | 0.287 | -139.6 | 11.41 | 3.721 | -18.7 | 0.124 | -10.4 | 0.245 | 140.9 | 1.1 | |
| 7.0 | 0.26 | -159.1 | 10.88 | 3.498 | -32 | 0.138 | -15.4 | 0.268 | 122.3 | 1.1 | |
| 7.5 | 0.232 | 177.6 | 10.28 | 3.264 | -45.6 | 0.151 | -21.8 | 0.3 | 102.9 | 1.1 | |
| 8.0 | 0.213 | 147.8 | 9.6 | 3.02 | -59.1 | 0.161 | -28.9 | 0.339 | 84.2 | 1.1 | |
| 8.5 | 0.218 | 120.2 | 8.7 | 2.724 | -71.7 | 0.169 | -35.8 | 0.385 | 69.5 | 1.1 | |
| 9.0 | 0.26 | 94.2 | 7.95 | 2.498 | -83.7 | 0.179 | -42.1 | 0.434 | 57.9 | 1.1 | |
| 9.5 | 0.303 | 74 | 6.98 | 2.233 | -96.2 | 0.189 | -49.2 | 0.487 | 47.9 | 1 | |
| 10.0 | 0.352 | 59.4 | 6.14 | 2.027 | -107.1 | 0.196 | -56.6 | 0.535 | 39.1 | 1 | |

Notes:

1. S-parameters are measured on a microstrip line made on 0.025 inch thick alumina carrier. The input reference plane is at the end of the input lead. The output reference plane is at the end of the output lead.

ADA-4643 Typical Scattering Parameters, $T_A = 25^\circ\text{C}$, $I_d = 60\text{ mA}$

| Freq. GHz | S_{11} | | dB | S_{21} | | S_{12} | | S_{22} | | K |
|--------------|----------|--------|-------|----------|--------|----------|-------|----------|--------|-----|
| | Mag. | Ang. | | Mag. | Ang. | Mag. | Ang. | Mag. | Ang. | |
| 0.1 | 0.126 | 2.4 | 17.88 | 7.834 | 175.9 | 0.089 | -0.7 | 0.194 | -3.8 | 1.1 |
| 0.5 | 0.165 | 18.1 | 17.73 | 7.696 | 159.9 | 0.088 | -3.8 | 0.196 | -9.9 | 1.1 |
| 0.9 | 0.252 | 19.6 | 17.36 | 7.377 | 144.3 | 0.085 | -6.4 | 0.227 | -16.1 | 1.1 |
| 1.0 | 0.261 | 16.4 | 17.24 | 7.28 | 140.6 | 0.085 | -6.9 | 0.233 | -18.8 | 1.1 |
| 1.5 | 0.33 | 2 | 16.63 | 6.787 | 123.3 | 0.081 | -8.2 | 0.244 | -33.2 | 1.1 |
| 1.9 | 0.359 | -7.4 | 16.16 | 6.424 | 110.3 | 0.079 | -8.4 | 0.241 | -44.4 | 1.1 |
| 2.0 | 0.365 | -9.8 | 16.05 | 6.343 | 107.2 | 0.078 | -8.4 | 0.239 | -47.2 | 1.1 |
| 2.5 | 0.386 | -21 | 15.49 | 5.948 | 91.9 | 0.077 | -7.8 | 0.221 | -61 | 1.2 |
| 3.0 | 0.387 | -31.5 | 14.98 | 5.61 | 77.4 | 0.077 | -6.7 | 0.195 | -76.8 | 1.2 |
| 3.5 | 0.381 | -43 | 14.49 | 5.301 | 63.1 | 0.078 | -5.5 | 0.168 | -96.2 | 1.3 |
| 4.0 | 0.363 | -56 | 14.02 | 5.025 | 49 | 0.081 | -4.3 | 0.153 | -120.3 | 1.3 |
| 4.5 | 0.344 | -70.7 | 13.58 | 4.777 | 35 | 0.086 | -3.5 | 0.157 | -146.9 | 1.3 |
| 5.0 | 0.323 | -87.3 | 13.04 | 4.488 | 21 | 0.093 | -3.7 | 0.172 | -169.4 | 1.2 |
| 5.5 | 0.31 | -105.8 | 12.54 | 4.235 | 7.5 | 0.101 | -4.6 | 0.195 | 173.4 | 1.2 |
| 6.0 | 0.301 | -123.6 | 11.98 | 3.971 | -6.2 | 0.111 | -6.9 | 0.22 | 158.2 | 1.2 |
| 6.5 | 0.281 | -140.6 | 11.44 | 3.735 | -19.4 | 0.124 | -10.2 | 0.239 | 141.4 | 1.1 |
| 7.0 | 0.257 | -159.9 | 10.9 | 3.507 | -32.7 | 0.138 | -15.2 | 0.262 | 122.5 | 1.1 |
| 7.5 | 0.228 | 176.3 | 10.29 | 3.271 | -46.3 | 0.151 | -21.5 | 0.294 | 103 | 1.1 |
| 8.0 | 0.212 | 145.6 | 9.61 | 3.022 | -59.8 | 0.161 | -28.6 | 0.333 | 84.3 | 1.1 |
| 8.5 | 0.218 | 117.8 | 8.72 | 2.728 | -72.4 | 0.169 | -35.6 | 0.38 | 69.5 | 1.1 |
| 9.0 | 0.257 | 92.7 | 7.94 | 2.494 | -84.1 | 0.178 | -41.8 | 0.429 | 57.9 | 1.1 |
| 9.5 | 0.302 | 72.9 | 6.98 | 2.234 | -96.4 | 0.189 | -48.9 | 0.482 | 47.9 | 1 |
| 10.0 | 0.359 | 57.7 | 6.11 | 2.02 | -107.7 | 0.196 | -56.4 | 0.531 | 39.2 | 1 |

Notes:

1. S-parameters are measured on a microstrip line made on 0.025 inch thick alumina carrier. The input reference plane is at the end of the input lead. The output reference plane is at the end of the output lead.

Ordering Information

| Part Number | No. of Devices | Container |
|--------------|----------------|----------------|
| ADA-4643-TR1 | 3000 | 7" Reel |
| ADA-4643-TR2 | 10000 | 13" Reel |
| ADA-4643-BLK | 100 | antistatic bag |

Package Dimensions Outline 43 SOT-343 (SC70 4-lead)

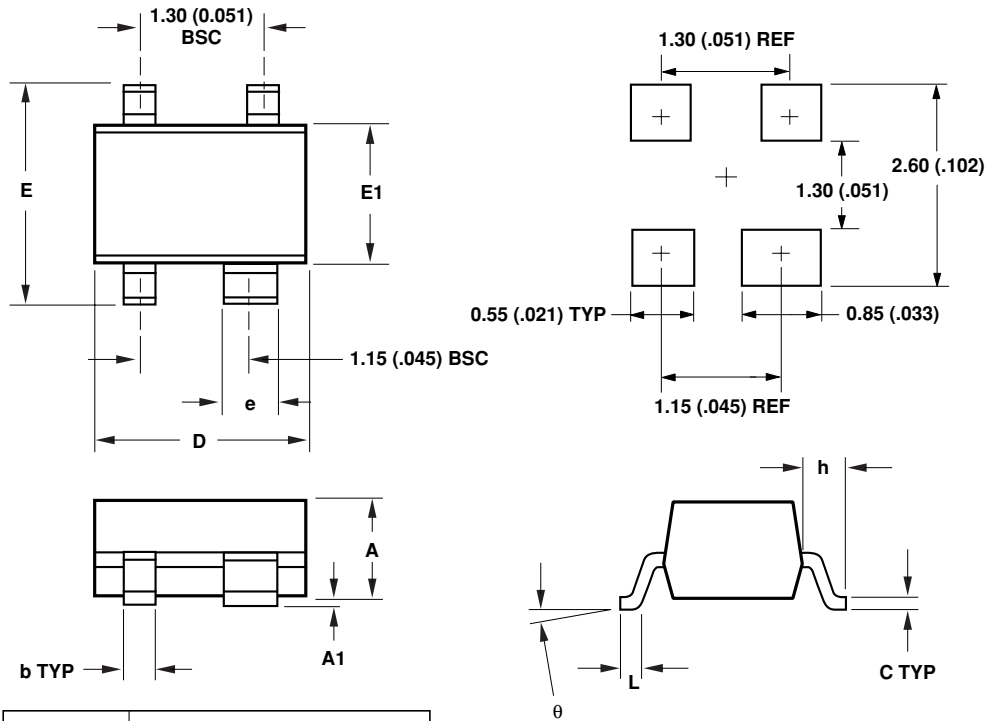

| SYMBOL | DIMENSIONS | |
|--------|-------------------|--------------|
| | MIN. | MAX. |
| A | 0.80 (0.031) | 1.00 (0.039) |
| A1 | 0 (0) | 0.10 (0.004) |
| b | 0.25 (0.010) | 0.35 (0.014) |
| C | 0.10 (0.004) | 0.20 (0.008) |
| D | 1.90 (0.075) | 2.10 (0.083) |
| E | 2.00 (0.079) | 2.20 (0.087) |
| e | 0.55 (0.022) | 0.65 (0.025) |
| h | 0.450 TYP (0.018) | |
| E1 | 1.15 (0.045) | 1.35 (0.053) |
| L | 0.10 (0.004) | 0.35 (0.014) |
| θ | 0 | 10 |

DIMENSIONS ARE IN MILLIMETERS (INCHES)

Device Orientation

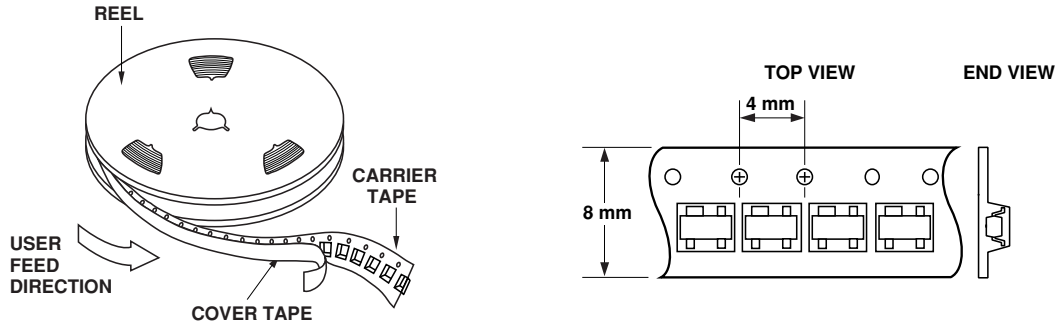

Tape Dimensions For Outline 4T

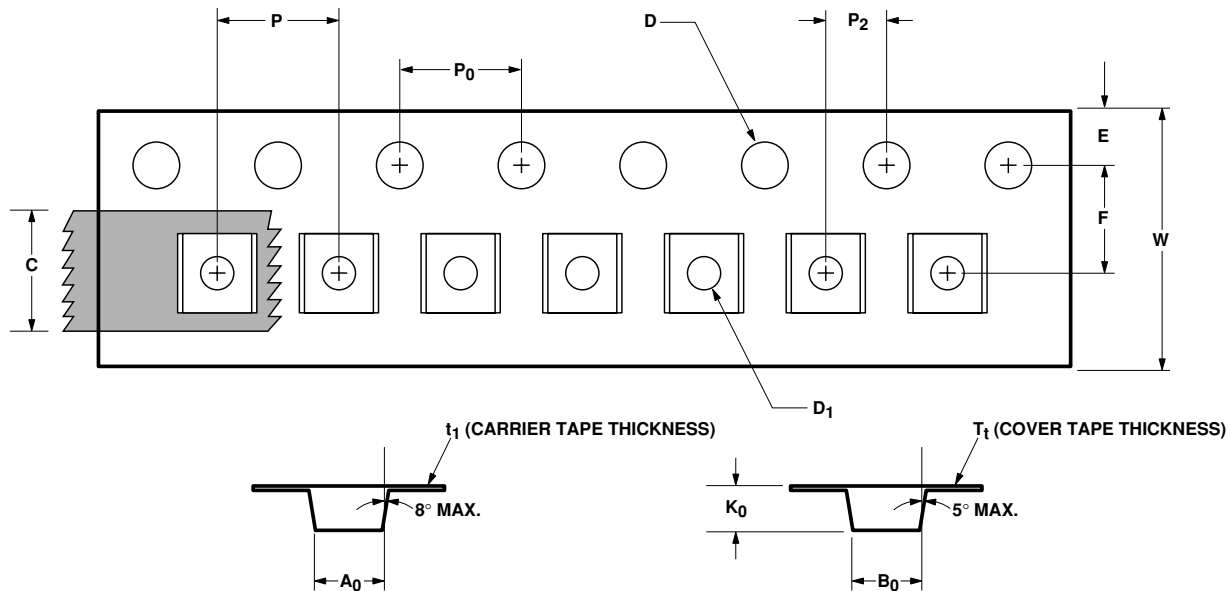

| | DESCRIPTION | SYMBOL | SIZE (mm) | SIZE (INCHES) |
|--------------|---|--------|-------------------|----------------------|
| CAVITY | LENGTH | A_0 | 2.24 ± 0.10 | 0.088 ± 0.004 |
| | WIDTH | B_0 | 2.34 ± 0.10 | 0.092 ± 0.004 |
| | DEPTH | K_0 | 1.22 ± 0.10 | 0.048 ± 0.004 |
| | PITCH | P | 4.00 ± 0.10 | 0.157 ± 0.004 |
| | BOTTOM HOLE DIAMETER | D_1 | $1.00 + 0.25$ | $0.039 + 0.010$ |
| PERFORATION | DIAMETER | D | 1.55 ± 0.05 | 0.061 ± 0.002 |
| | PITCH | P_0 | 4.00 ± 0.10 | 0.157 ± 0.004 |
| | POSITION | E | 1.75 ± 0.10 | 0.069 ± 0.004 |
| CARRIER TAPE | WIDTH | W | 8.00 ± 0.30 | 0.315 ± 0.012 |
| | THICKNESS | t_1 | 0.255 ± 0.013 | 0.010 ± 0.0005 |
| COVER TAPE | WIDTH | C | 5.4 ± 0.10 | 0.205 ± 0.004 |
| | TAPE THICKNESS | T_t | 0.062 ± 0.001 | 0.0025 ± 0.00004 |
| DISTANCE | CAVITY TO PERFORATION (WIDTH DIRECTION) | F | 3.50 ± 0.05 | 0.138 ± 0.002 |
| | CAVITY TO PERFORATION (LENGTH DIRECTION) | P_2 | 2.00 ± 0.05 | 0.079 ± 0.002 |

For product information and a complete list of Agilent contacts and distributors, please go to our web site.

www.agilent.com/semiconductors

E-mail: SemiconductorSupport@agilent.com

Data subject to change.

Copyright © 2003 Agilent Technologies, Inc.

April 25, 2003

5988-9273EN



Agilent Technologies