

**User Manual**  
Rev. 1.2  
**CC2400DBK Demonstration Board Kit**



## Table of contents

<b>INTRODUCTION</b> .....	<b>3</b>
<b>PCB</b> .....	<b>4</b>
RF SECTION .....	4
ANTENNA .....	4
POWER SUPPLY SECTION .....	7
RS-232 INTERFACE .....	8
MICROCONTROLLER AND USER INTERFACE .....	8
PCB LAYOUT .....	11
<b>USING THE CC2400DB DEMONSTRATION BOARD</b> .....	<b>22</b>
CC2400 SOFTWARE DOWNLOAD AND EVALUATION USING AVR STUDIO 4 .....	22
RC OSCILLATOR .....	23
MICROCONTROLLER EEPROM MAPPING .....	23
IN SYSTEM PROGRAMMING .....	24
BOOTLOADER .....	25
INTRODUCTION TO EXAMPLES PROVIDED WITH CC2400DB .....	26
SETTING UP A SOFTWARE PROJECT FOR CC2400 .....	27
HARDWARE DEFINITION FILES (HDF) .....	27
HARDWARE LIBRARY FILES (HLF) .....	27
CONFIGURE OUTPUT PROFILE .....	28
DATA PACKET DESCRIPTION .....	28
DATA TRANSMISSION PROTOCOL .....	28
<b>TROUBLESHOOTING</b> .....	<b>29</b>
IT DOES NOT WORK .....	29
I CANNOT PROGRAM THE AVR USING THE SERIAL PORT .....	29
<b>REFERENCES</b> .....	<b>29</b>

## Introduction

The CC2400 single-chip RF transceiver provides a highly integrated, flexible low-cost solution for applications using the world wide unlicensed 2.4 GHz frequency band. The CC2400DBK demonstration board kit is a complement to the development kit (DK) as the hardware is representative of an actual application, and it is well suited as a prototyping platform for application code.

The CC2400DBK Demonstration Board Kit includes two CC2400DB Demonstration Boards. These boards contain a CC2400 with necessary support components, an Atmel mega8 AVR microcontroller, a PCB antenna, as well as a joystick, buttons and LEDs that can be used to implement a visual user application interface. The demonstration board is also furnished with connectors where all of the internal signals on the PCB are available.

This User Manual describes how to use the CC2400DBK Demonstration Board Kit. Atmel's AVR Studio and associated software is used to program and debug software. Please see the reference section of this document for links to Atmel's documentation on how to use their tools.

Your CC2400DBK Demonstration Board Kit should contain the following items:

Kit contents	
Item	Number of articles
Demonstration Board (CC2400DB)	2
Quick Start instructions	1
CC2400 sample kit	1
RS-232 cables	2

### Important:

*Contact your local telecommunication authorities before transmitting an RF signal to ensure that there are no local restrictions on the use of the 2400 –2483.5 MHz ISM band. The CC2400 operates in the 2.4 GHz frequency band. Although this frequency band is usually described as "world-wide", some countries do not allow unlicensed operation in this band.*

## PCB

Figure 1 depicts an overview of the CC2400DB with description of the various components embedded on the PCB.

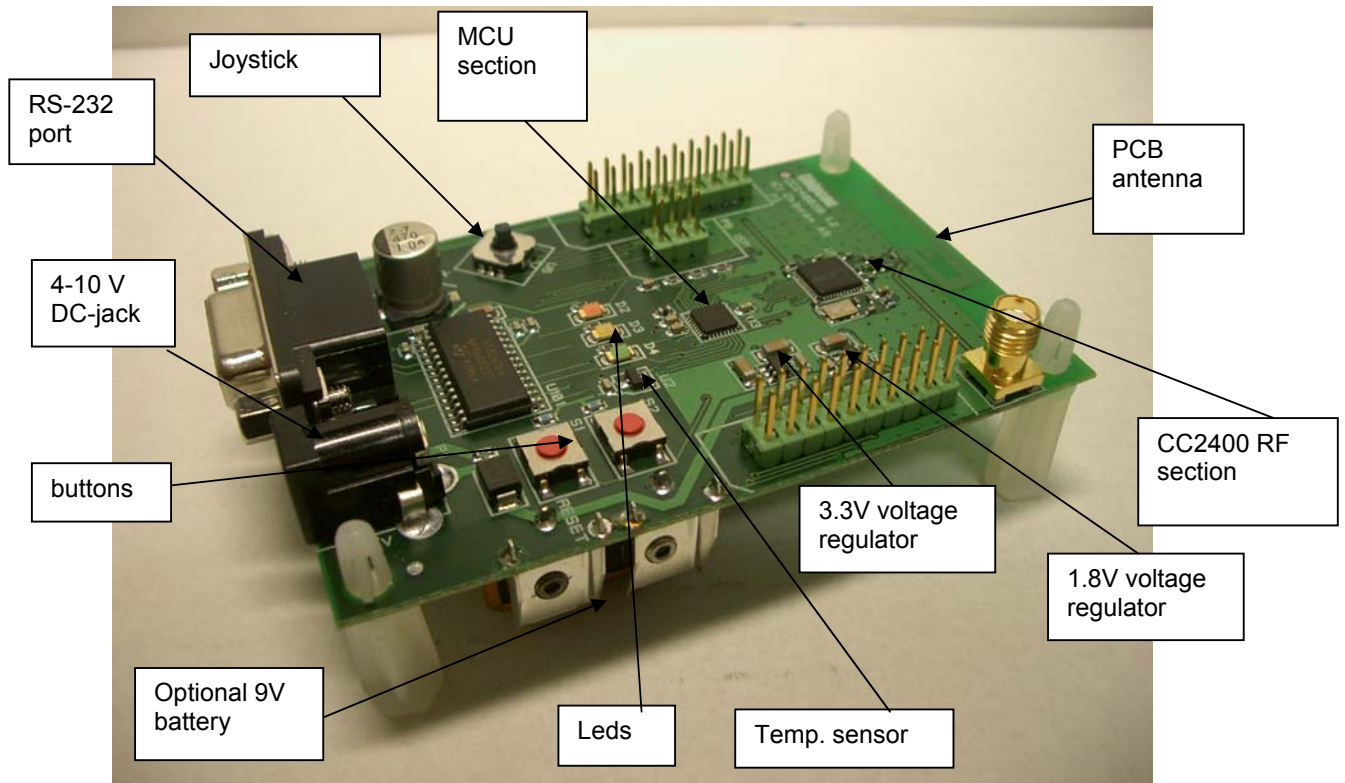

**Figure 1: CC2400DB overview**

### RF Section

The CC2400DB RF section includes all the necessary components for correct operation. The CC2400 is connected to a 16 MHz crystal. A small 2.4 GHz PCB antenna is also included. RF test and measurement equipment can be mounted the PCB by the use of an SMA connector, by swapping capacitor placement of C63 and C62. See schematics for details. The RF layout is identical to the CC2400EM, which is part of the CC2400DK Development Kit.

#### Important:

*The CC2400DB demonstration board output power must be reduced for a 100% transmission duty cycle to be compliant with the FCC 15<sup>th</sup> harmonics regulation requirement. At the moment the design is 1 dB above the limit.*

### Antenna

The PCB antenna is a so-called Inverted-F type. The Inverted-F antenna is a wire monopole where the top section is folded down to be parallel with the ground plane. By folding the antenna down you will reduce the height and maintain a resonant wire length. A capacitance will be introduced to the input impedance of the antenna due to the parallel section. However, as a rule of thumb design guide, the length + height (L+H) will be approximately equal to a

quarter wavelength ( $\lambda/4$ ). A reduction of the antenna height (H) will in general decrease the antenna bandwidth. Please see figure 3 for the antenna dimensions.

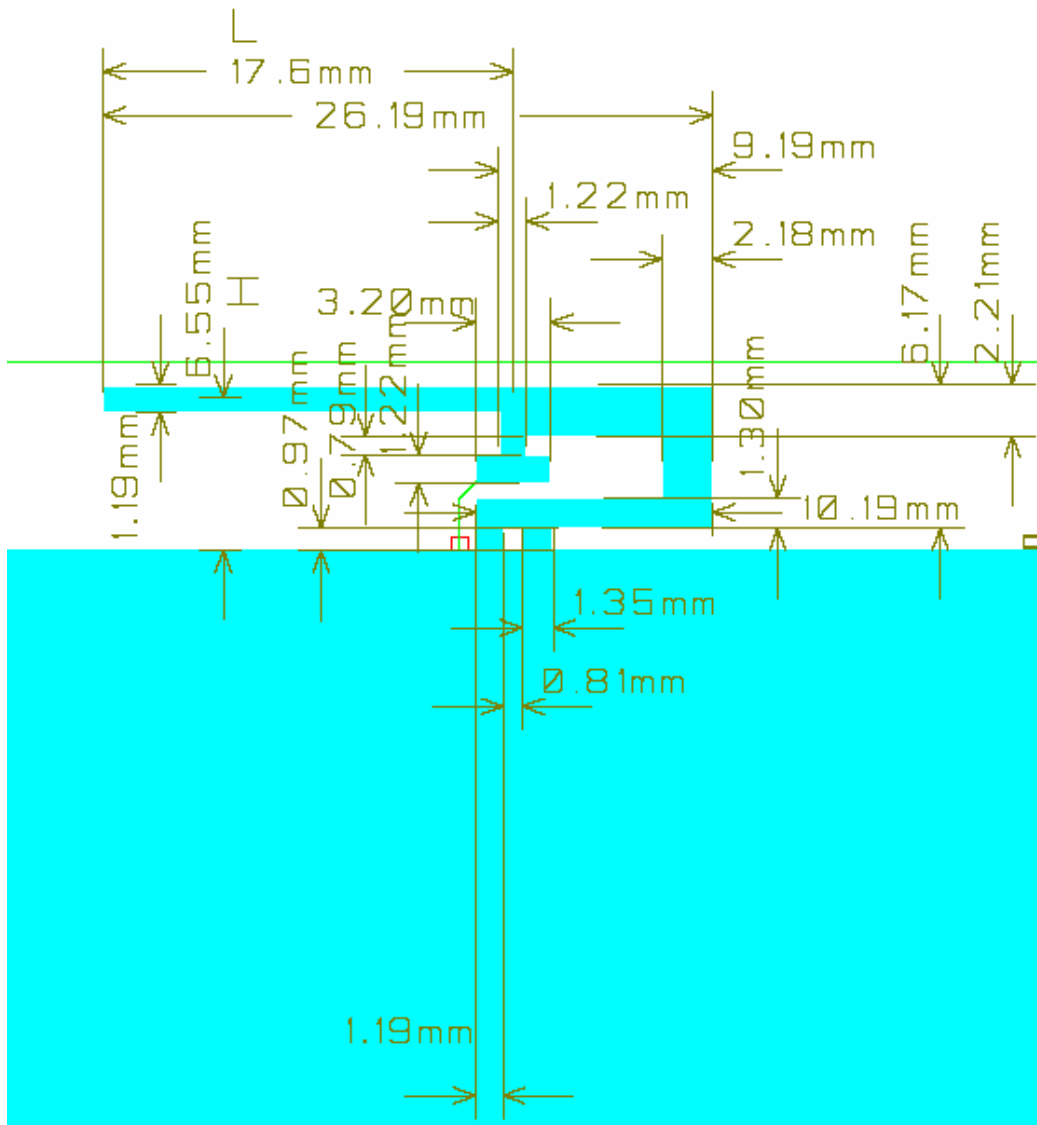

**Figure 2: Antenna dimensions**

The height of the antenna is defined as the distance from the ground plane to the parallel section, and the length is from the end of the antenna parallel section to the feed point.

$$\text{Length: } L = (26.19 \text{ mm} - 9.19 \text{ mm} + 1.22 \text{ mm} \times \frac{1}{2}) = 17.61 \text{ mm}$$

$$\text{Height: } H = (6.17 \text{ mm} + 0.97 \text{ mm} - 1.19 \text{ mm} \times \frac{1}{2}) = 6.55 \text{ mm}$$

$$\text{Quarter wavelength: } \lambda/4 = (L + H) = 17.61 \text{ mm} + 6.55 \text{ mm} = 24.16 \text{ mm}$$

The physical size of the antenna is decreased somewhat compared to the theoretical length, ( $\lambda = c/4 \cdot f = 3 \times 10^8 / 4 \times 2.45 \times 10^9$ ) = 30.61 mm

The radiated pattern for the PCB antenna was measured with the horizontal polarization direction for the CC2400DB by measuring with vertical and horizontal mounting of the demonstration board.

**Important:**

*In practical range testing outdoors with line-of-sight (LOS) and use of the rfBlinkLed application example, the following range has been verified at Chipcon Norway with optimal SmartRF Studio settings for the respective data rates:*

1. Data rate settings 1 Mbps, range measured: 140 meters
2. Data rate settings 250 kbps, range measured: 240 meters

*Please note that these range tests were performed at 0° C with a simple packet protocol, no link margin, no robust protocol, close to the sensitivity limit of CC2400, and no retransmission.*

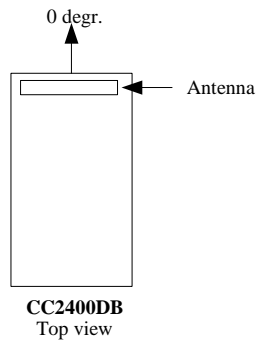
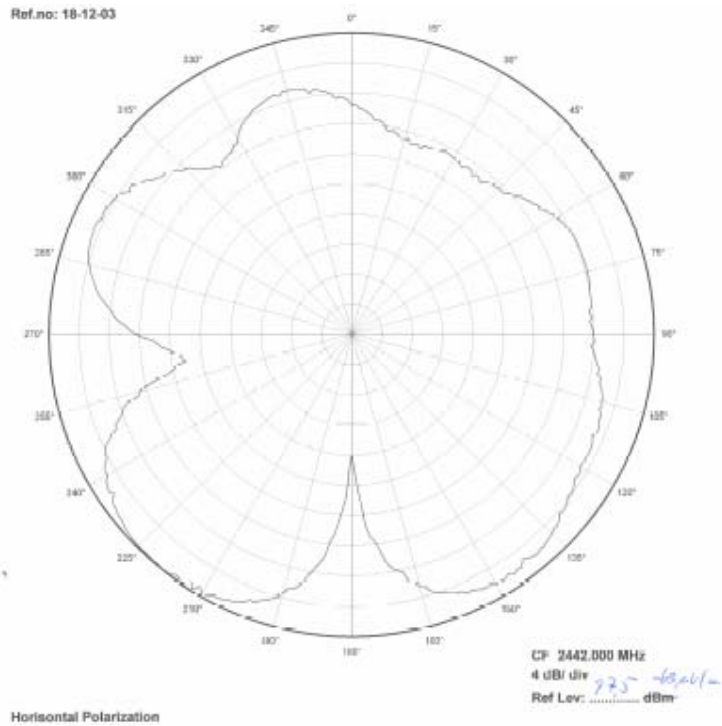

**Figure 3: Radiated pattern horizontal mounting**

Figure 3 depicts the antenna pattern while the CC2400DB is mounted horizontally with the antennas parallel section aligned to the 0 degree direction.

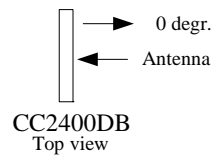
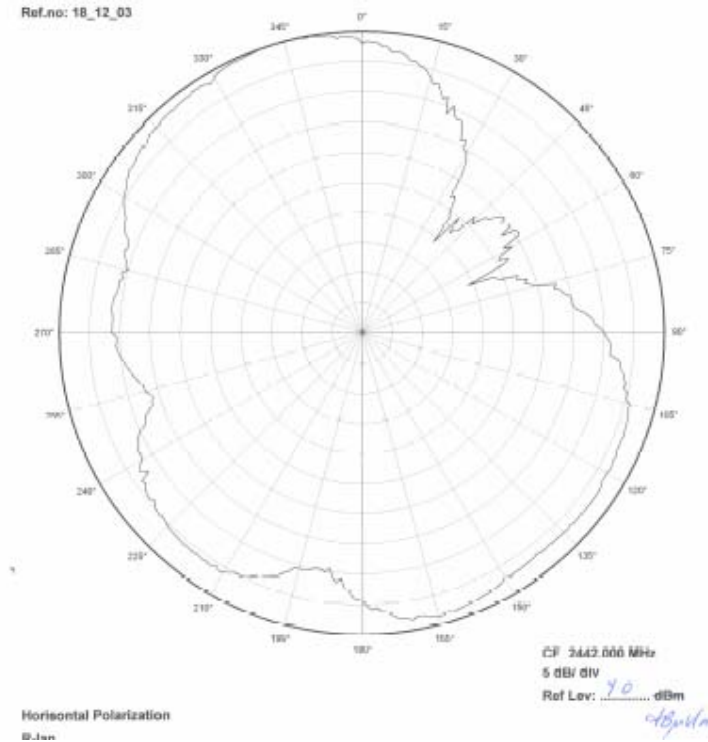

**Figure 4: Radiated antenna pattern vertical mounting**

Figure 4 depicts the antenna pattern while the CC2400DB is mounted vertically with the antennas parallel section aligned to the 0 degree direction.

**Power supply section**

The power supply section contains two voltage regulators: a 3.3 V regulator for use by the microcontroller and the I/O pins of the CC2400, and a 1.8 V regulator for powering the CC2400 core.

A diode prevents permanent damage if wrong polarity is applied to the board. There are two power connectors; a 2.5mm DC jack-type connector allows you to connect an unregulated battery eliminator easily (the positive supply is on the center pin), and a connector for a 9V battery on the bottoms side of the PCB. It is also possible to use 3 or 4 AA or AAA alkaline cells to power the CC2400DB if a suitable battery pack is used.

### RS-232 interface

A serial port is included on the CC2400DB. This port is used when software is programmed into the AVR MCU using the boot loader, and is also used by several of the example programs. The port includes support for RTS/CTS-type hardware flow control (handshaking).

**Important:**

*It is important to be aware that maximum data rate for the Atmega8 RS-232 interface on CC2400DB is 38.4 Kbps due to the use of the internal RC oscillator. Please see the Atmega8 datasheet for a baud rate error overview with the respect to a selected oscillator frequency.*

### Microcontroller and user interface

The microcontroller used is an AVR Atmega8L from Atmel. This controller has 8 KB of Flash program memory, 1 KB of SRAM data memory and 512 bytes of non-volatile EEPROM data memory. The controller runs on its internal oscillator, and is interfaced to the CC2400 via its built-in SPI interface as well as some general I/O pins.

The MCU is also connected to three LEDs, a joystick and an extra button for user interface purposes. The different examples use these peripherals differently. An analog temperature sensor is also included.

An ISP connector is provided for programming the AVR without using the serial port. In this case an Atmel AVR programmer should be connected to this connector.

All of the I/O pins are connected to footprints for 2 x 10 pin-row connectors. These connectors are compatible with Agilent logic analyzer probes, and can be used either for testing or for prototyping. For instance, it is possible to add a daughter board with additional circuitry using these connectors.

AVR Pin Number	AVR pin name	Pin usage	I/O connector
1	PD3/INT1	CC2400 DIO/DKT	P4 pin 14
2	PD4/XCK/T0	Yellow LED	P4 pin 7
7	PB6/XTAL1/TOSC 1	Joystick up	P3 pin 9
8	PB7/XTAL2/TOSC 2	Joystick right	P3 pin 7
9	PD5/T1	Joystick down	P3 pin 6
10	PD6/AIN0	Joystick left	P3 pin 3
11	PD7/AIN1	Joystick center push	P3 pin 5
12	PB0/ICP	RS-232 handshaking RTS, push button	P3 pin 13
13	PB1/OC1A	RS-232 handshaking CTS, Red LED	P3 pin 17
14	PB2/SS/OC1B	CC2400 chip select	P4 pin 13
15	PB3/MOSI/OC2	CC2400 SI, AVR ISP	P4 pin 8
16	PB4/MISO	CC2400 SO, AVR ISP	P4 pin 6
17	PB5/SCK	CC2400 SCK, AVR ISP	P4 pin 4
19	ADC6	Not used	P4 pin 11
22	ADC7	Temperature sensor	P4 pin 9
23	PC0/ADC0	CC2400 GIO6	P4 pin 10



24	PC1/ADC1	CC2400 GIO1	P4 pin 19
25	PC2/ADC2	CC2400 TX	P4 pin 16
26	PC3/ADC3	CC2400 RX	P4 pin 18
27	PC4/ADC4/SDA	RS-232 on/off	P3 pin 11
28	PC5/ADC5/SCL	Green LED	P4 pin 5
29	PC6/RESET	Reset button, AVR ISP	P4 pin 3
30	PD0/RXD	RS-232 receive data from PC	P3 pin 15
31	PD1/TXD	RS-232 transmit data to PC	P3 pin 19
32	PD2/INT0	CC2400 DCLK/FIFO	P4 pin 12

**Table 1: AVR I/O pins**

Pin number	Signal name in schematic	Pin usage	CC2400 pin	AVR pin
1				
2		Unregulated supply voltage		
3	PD6	Joystick left		10 (PD6/AIN0)
4				
5	PD7	Joystick center push		11 (PD7/AIN1)
6	PD5	Joystick down		9 (PD5/T1)
7	PB7	Joystick right		8 (PB7/XTAL2/TOSC2)
8				
9	PB6	Joystick up		7 (PB6/XTAL1/TOSC1)
10				
11	FORCE_ON	RS-232 on/off		27 (PC4/ADC4/SDA)
12				
13	RTS	RS-232 handshaking, push button		12 (PB0/ICP)
14				
15	RXD0	RS-232 data from PC		30 (PD0/RXD)
16				
17	CTS	RS-232 handshaking, Red LED		13 (PB1/OC1A)
18				
19	TXD0	RS-232 data to PC		31 (PD1/TXD)
20	GND	Ground		

**Table 2: P3 pinout**

Pin number	Signal name in schematic	Pin usage	CC2400 pin	AVR pin
1				
2				
3	RESET	Reset		29 (PC6/RESET)
4	SCLK	CC2400 serial clock, AVR ISP	32 (SCLK)	17 (PB5/SCK)
5	PC5	Green LED		28 (PC5/ADC5/SCL)
6	SO	CC2400 SPI out, AVR ISP	34 (SO)	16 (PB4/MISO)
7	PD4	Yellow LED		2 (PD4/XCK/T0)
8	SI	CC2400 SPI in, AVR ISP	33 (SI)	15 (PB3/MOSI/OC2)
9	ADC7	Temperature sensor		22 (ADC7)
10	GIO6	CC2400 GIO6	35 (GIO6)	23 (PC0/ADC0)
11	ADC6	Not used		19 (ADC6)
12	DCLK/FIFO	CC2400 DCLK/FIFO	30 (DCLK/FIFO)	32 (PD2/INT0)
13	CSn	CC2400 chip select	31 (CSn)	14 (PB2/SS/OC1B)
14	DIO/PKT	CC2400 DIO/PKT	29 (DIO/PKT)	1 (PD3/INT1)
15	3.3V	3.3V regulated supply		
16	TX	CC2400 TX	28 (TX)	25 (PC2/ADC2)
17	1.8V	1.8V regulated supply		
18	RX	CC2400 RX	27 (RX)	26 (PC3/ADC3)
19	GIO1	CC2400 GIO1	21 (GIO1)	24 (OC1/ADC1)
20	GND	Ground		

**Table 3: P4 pinout**

### PCB layout

RF circuits operating at high frequencies are normally sensitive to the physical layout of the PCB. Chipcon has carefully optimized the layout of the CC2400DB Demonstration Board and we therefore recommend that our customer copy, at least the RF parts and the decoupling around the CC2400 when making their own PCB designs.

The PCB is of a 4-layer type in order to provide a well-defined ground plane as well as adequate routing space. The laminate used is standard FR-4 board material. The PCB is 1.0mm thick, with layer 1 on the topside, layers 2 and 3 are internal layers and layer 4 is on the bottom side. Layers 1 and 4 are used for routing, while layer 2 is a ground plane and layer 3 is used for power routing. All areas in the RF section that are not utilized for routing are filled with copper connected to ground to provide RF shielding. The ground planes on all layers are stitched together with closely spaced vias.

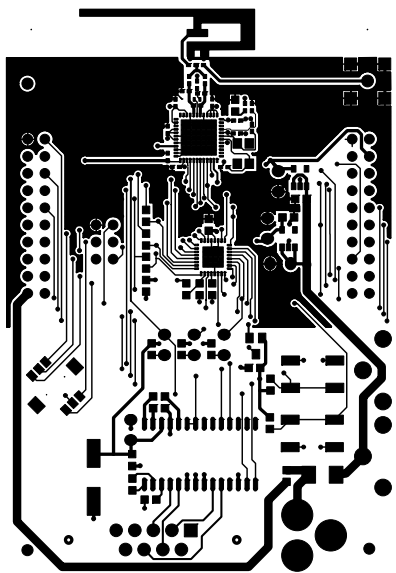

Layer 1

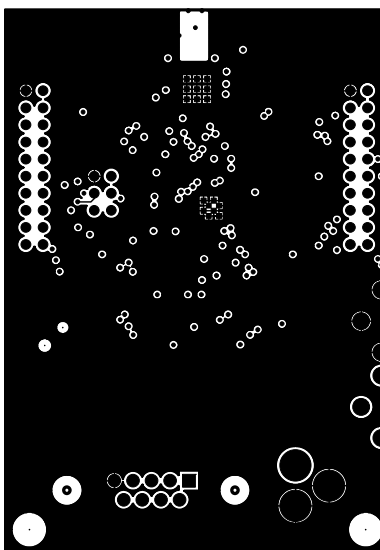

Layer 2

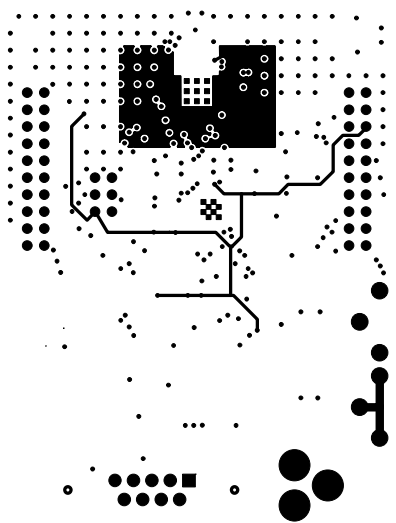

Layer 3

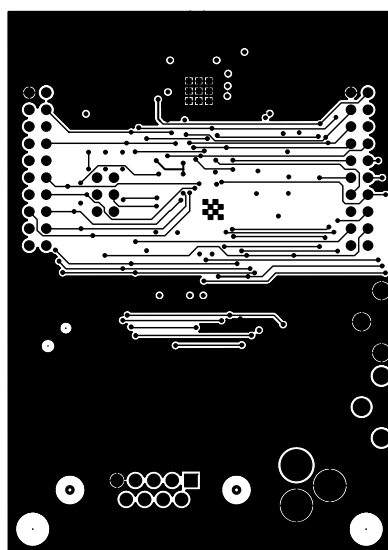

Layer 4

Figure 5: CC2400DB PCB layout

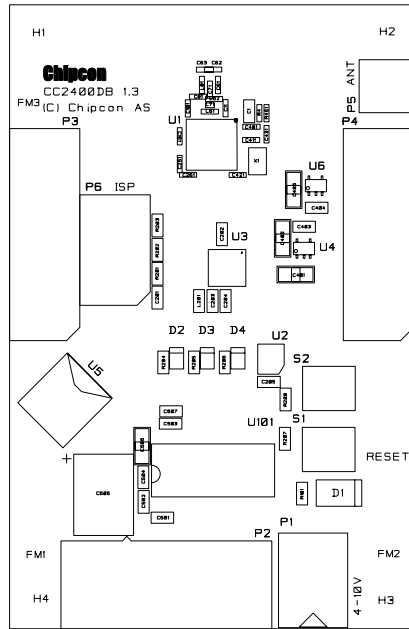

**Top Assembly**

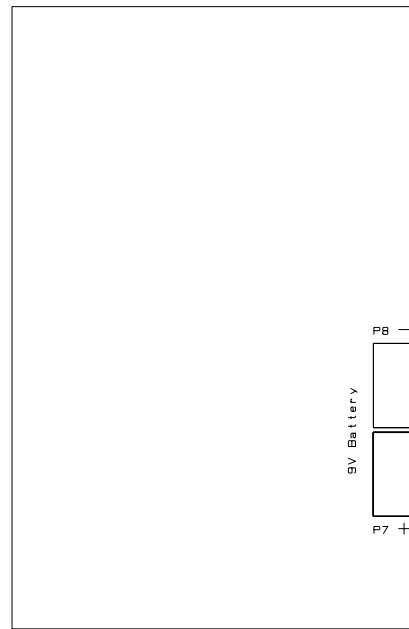

**Bottom Assembly**

**Figure 6: CC2400DB PCB layout silkscreen**

Schematic

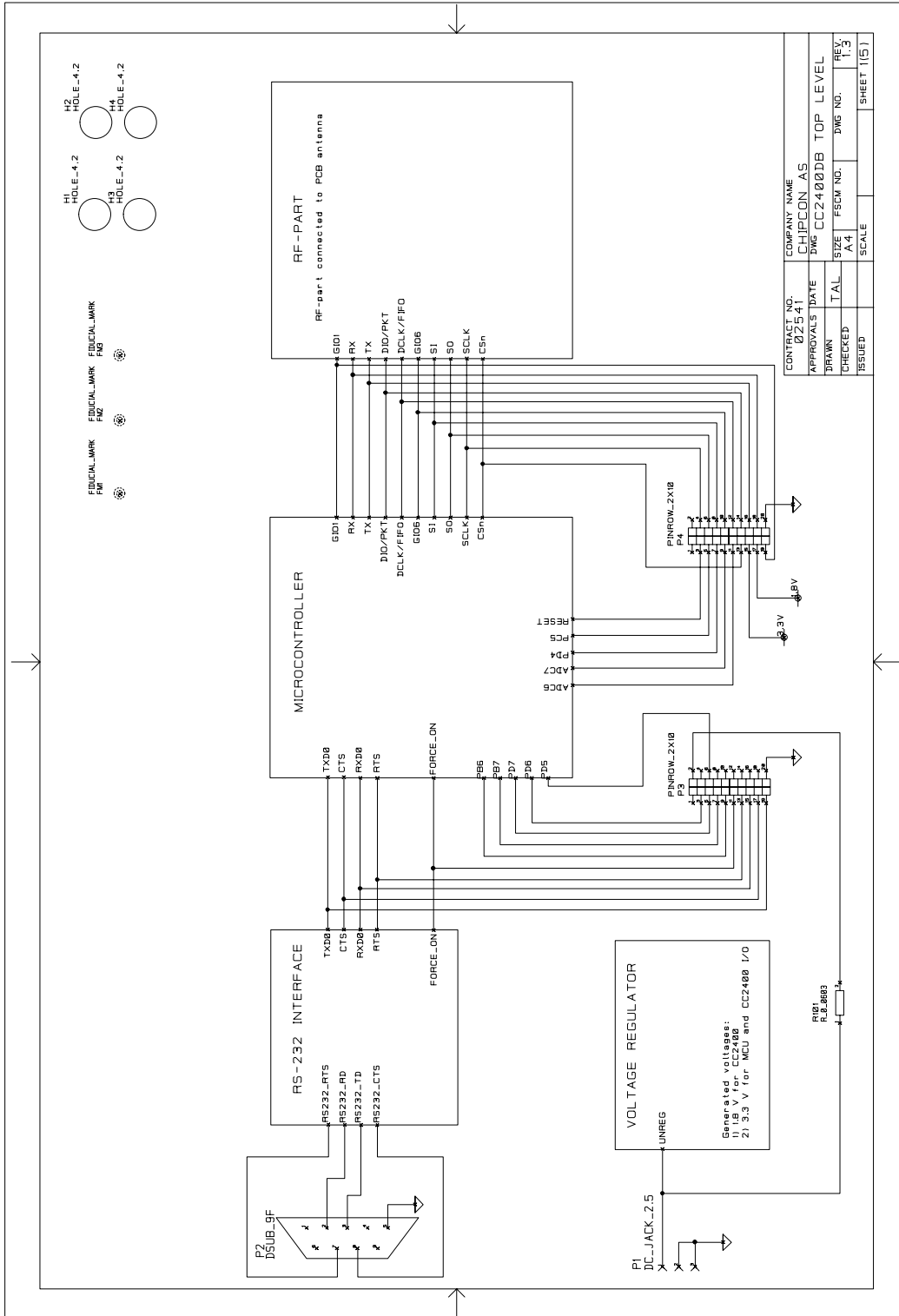
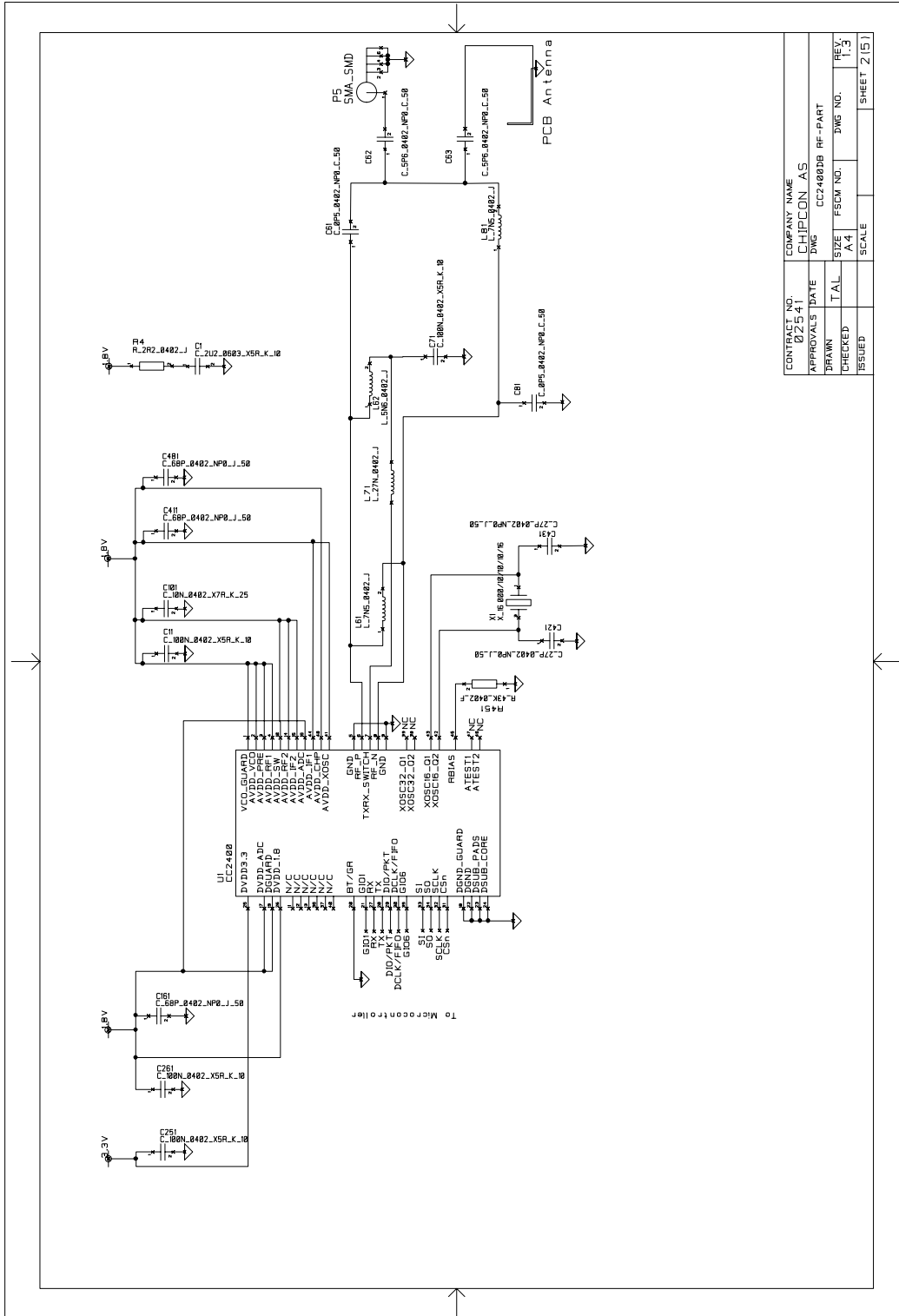
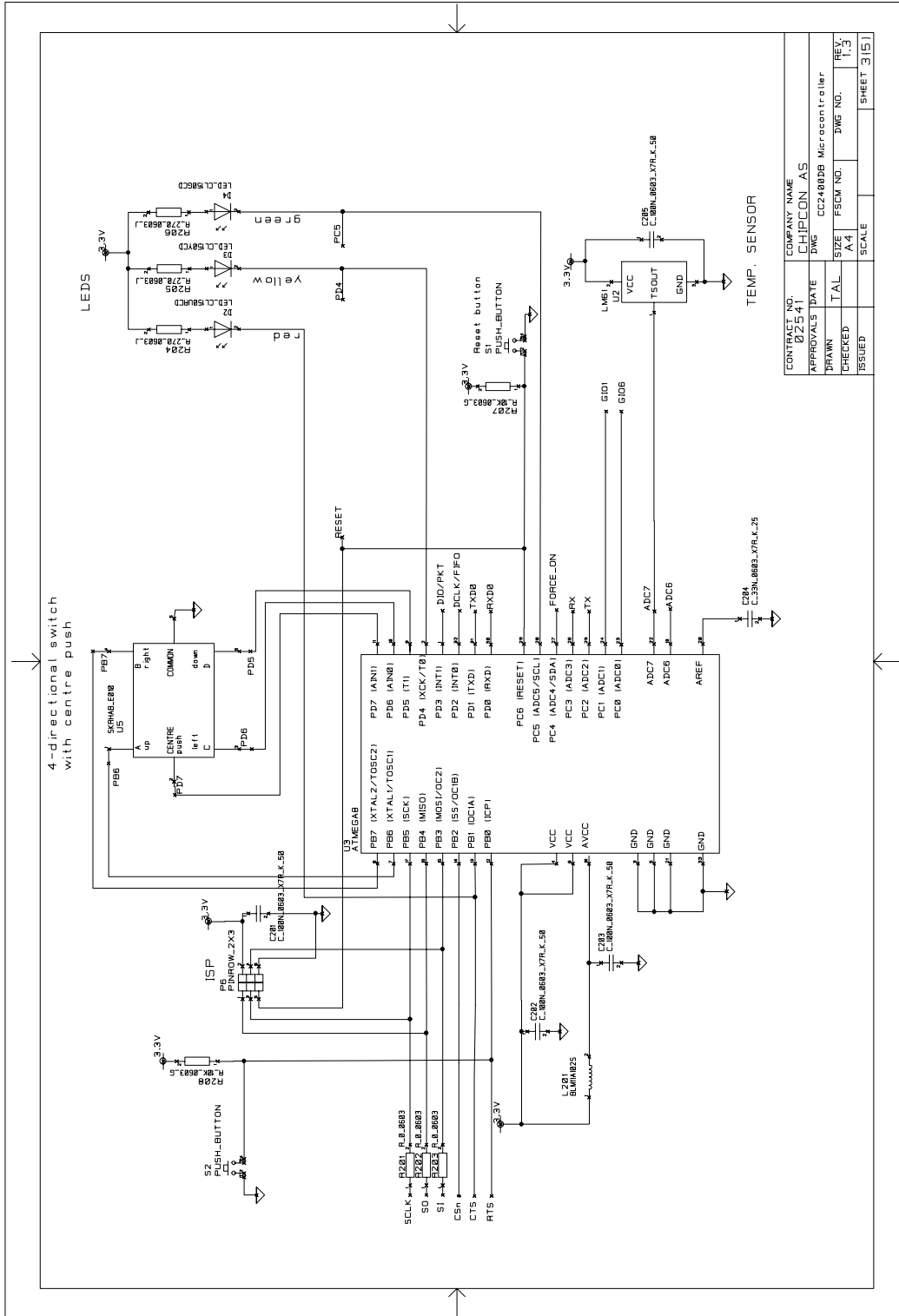

Figure 7: CC2400DB schematic page 1



CONTRACT NO.	02541	COMPANY NAME	CHIPCON AS
APPROVALS DATE		DWG	CC2400DB RF-PART
DRAWN	TAL	SIZE	A4
CHECKED		FSCW NO.	REV. 1.3
ISSUED		SCALE	SHEET 2   51

Figure 8: CC2400DB schematic page 2



CONTRACT NO.	02541	COMPANY NAME	CHIPCON AS
APPROVALS DATE		DWG	CC2400DB Microcontroller
DRAWN	TAL	SIZE	A4
CHECKED		FSCW NO.	
ISSUED		SCALE	
			SHEET 3   5

Figure 9: CC2400DB schematic page 3



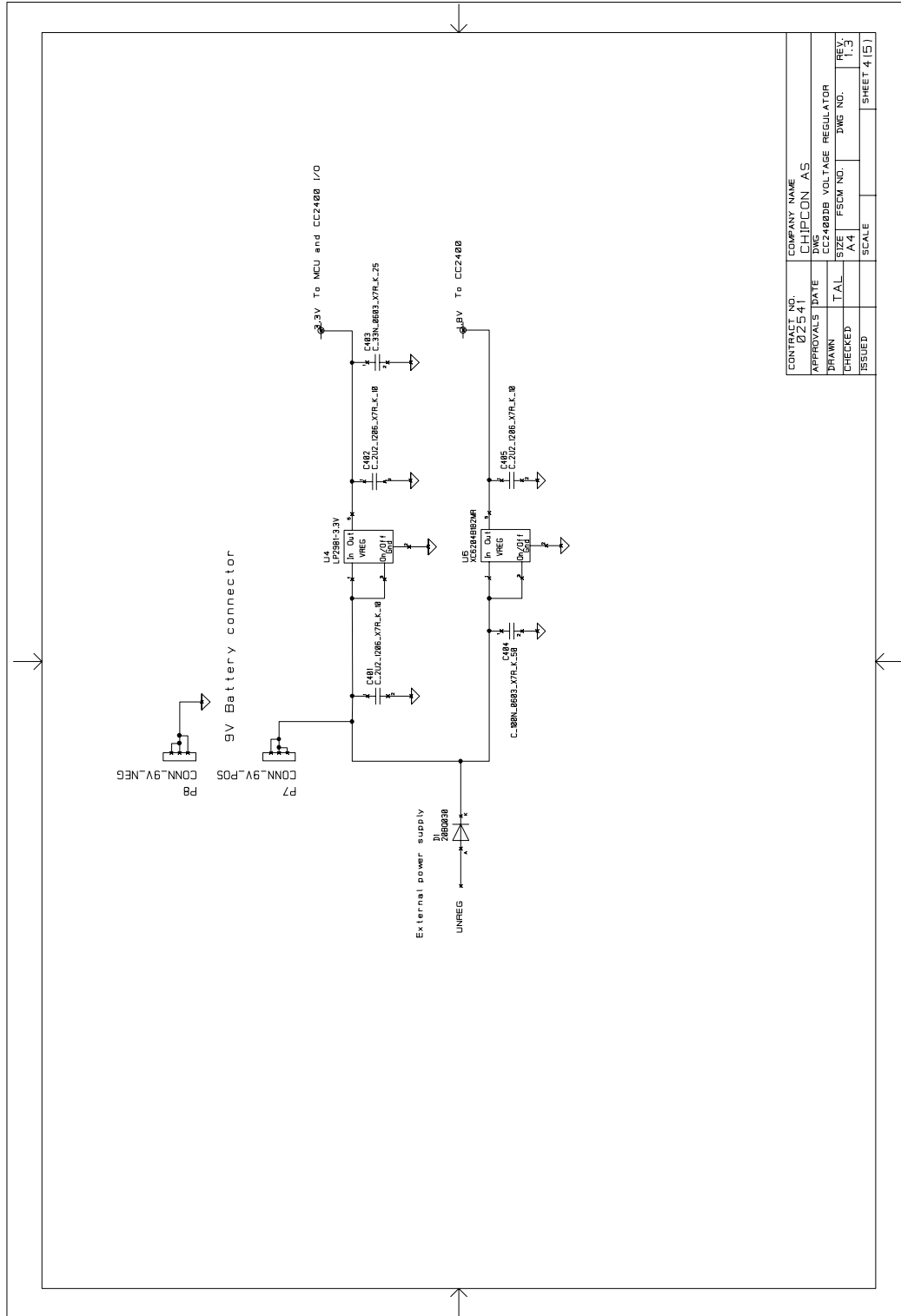
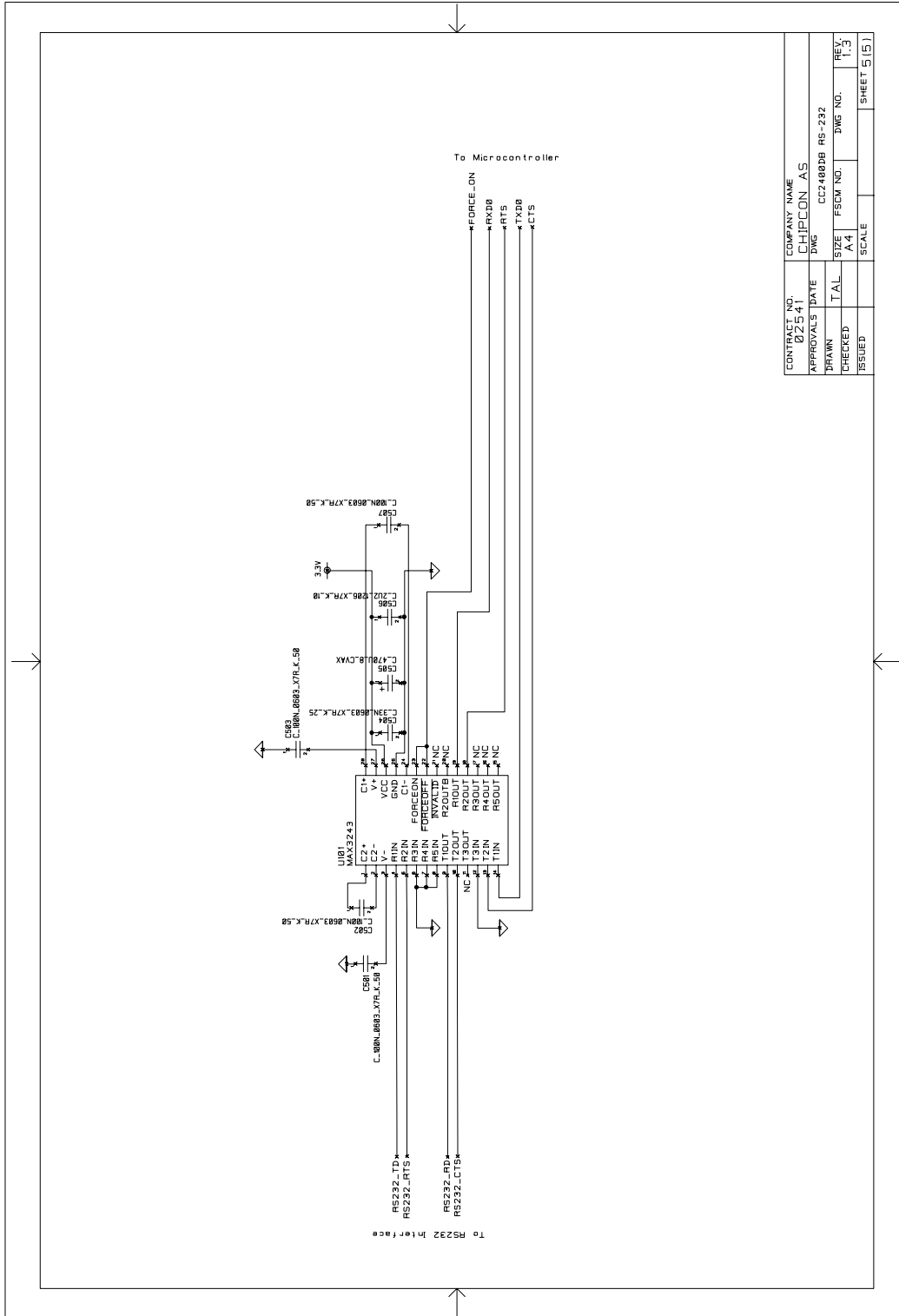

Figure 10: CC2400DB schematic page 4



CONTRACT NO.	02541	COMPANY NAME	CHIPCON AS
APPROVALS DATE		DWG	CC2400DB RS-232
DRAWN	TAL	SIZE	A4
CHECKED		FSCW NO.	
ISSUED		SCALE	
		REV.	1.3
		DWG NO.	
		SHEET	5   51

Figure 11: CC2400DB schematic page 5

### Bill of materials

Bill of materials, CC2400DB Top-level section			
Reference	Description	Value	Part
P1	DC jack, 2.5mm center pin		DC_JACK_2.5
P2	D-Sub, 9 pin, female		DSUB_9F
P3	PINROW_2X10		Pin row, 2x10
P3	PINROW_2X10		Pin row, 2x10
R101	Resistor 0603	0 $\Omega$	Not Mounted

Bill of materials, CC2400DB RF Section			
Reference	Description	Value	Part
C1	Capacitor 0603	2.2 $\mu$ F, 10%	C_2U2_0603_X5R_K_10
C11	Capacitor 0402	100 nF, 10%	C_100N_0402_X5R_K_10
C61	Capacitor 0402	0.5 pF, $\pm$ 0.25 pF	C_0P5_0402_NP0_C_50
C62	Capacitor 0402	5.6 pF, $\pm$ 0.25 pF	Not Mounted
C63	Capacitor 0402	5.6 pF, $\pm$ 0.25 pF	C_5P6_0402_NP0_C_50
C71	Capacitor 0402	100 nF, 10%	C_100N_0402_X5R_K_10
C81	Capacitor 0402	0.5 pF, $\pm$ 0.25 pF	C_0P5_0402_NP0_C_50
C101	Capacitor 0402	10 nF, 10%	C_10N_0402_X7R_K_25
C161	Capacitor 0402	68 pF, 5%	C_68P_0402_NP0_J_50
C251	Capacitor 0402	100 nF, 10%	C_100N_0402_X5R_K_10
C261	Capacitor 0402	100 nF, 10%	C_100N_0402_X5R_K_10
C411	Capacitor 0402	68 pF, 5%	C_68P_0402_NP0_J_50
C421	Capacitor 0402	27 pF, 5%	C_27P_0402_NP0_J_50
C431	Capacitor 0402	27 pF, 5%	C_27P_0402_NP0_J_50
C481	Capacitor 0402	68 pF, 5%	C_68P_0402_NP0_J_50
L61	Inductor 0402	7.5 nH, 5%	L_7N5_0402_J
L62	Inductor 0402	5.6 nH, 5%	L_5N6_0402_J
L71	Inductor 0402	27 nH, 5%	L_27N_0402_J
L81	Inductor 0402	7.5 nH, 5%	L_7N5_0402_J
P5	Surface-mount SMA, straight		SMA_SMD
R4	Resistor 0402	2.2 $\Omega$ , 5%	R2R2_0402_J
R451	Resistor 0402	43 k $\Omega$ , 1%	R_43K_0402_F

Bill of materials, CC2400DB RF Section			
Reference	Description	Value	Part
U1	Single-chip transceiver		CC2400
X1	Crystal, ceramic SMD 4x25mm		X_16.000/10/10/10/16 (Toyocom TSX-10A 16M 16pF)

Note: The crystal X1 mounted on the EM board is a 16.000 MHz crystal, with  $\pm 10$  ppm initial tolerance,  $\pm 10$  ppm drift over temperature and a temperature range of  $-10^{\circ}$  C to  $+60^{\circ}$  C. The crystal is designed for 16 pF load capacitance. In an actual application, the tolerance, drift and temperature range of the crystal must be considered with application requirements in mind. Please consult the data sheet and SmartRF<sup>®</sup> Studio for more information. It is possible to choose a larger crystal package to save cost. The crystal should have an ESR of 60  $\Omega$  or less.

Bill of materials, CC2400DB MCU section			
Reference	Description	Value	Part
C201	Capacitor 0603	100 nF, 10%	C_100N_0603_X7R_K_50
C202	Capacitor 0603	100 nF, 10%	C_100N_0603_X7R_K_50
C203	Capacitor 0603	100 nF, 10%	C_100N_0603_X7R_K_50
C204	Capacitor 0603	33 nF, 10%	C_33N_0603_X7R_K_25
C205	Capacitor 0603	100 nF, 10%	C_100N_0603_X7R_K_50
D2	LED, red, SMD	Red	LED_CL150URCD
D3	LED, yellow, SMD	Yellow	LED_CL150YCD
D4	LED, green, SMD	Green	LED_CL150GCD
L201	EMI filter bead		BLM18AG102SN1D
P6	ISP connector		PINROW_2X3
R201	Resistor 0603	0 $\Omega$ , 1%	R_0_0603
R202	Resistor 0603	0 $\Omega$ , 1%	R_0_0603
R203	Resistor 0603	0 $\Omega$ , 1%	R_0_0603
R204	Resistor 0603	270 $\Omega$ , 1%	R_270_0603_J
R205	Resistor 0603	270 $\Omega$ , 1%	R_270_0603_J
R206	Resistor 0603	270 $\Omega$ , 1%	R_270_0603_J
R207	Resistor 0603	10 k $\Omega$ , 1%	R_10K_0603_G
R208	Resistor 0603	10 k $\Omega$ , 1%	R_10K_0603_G
S1	Push button, SMD		ALPS-SKHUAF
S2	Push button, SMD		ALPS-SKHUAF
U2	Temperature sensor, SOT23		LM61
U3	Atmel microcontroller, MLF32		Atmega8

Bill of materials, CC2400DB MCU section			
Reference	Description	Value	Part
U5	4-directional switch with a center push		skrhab_e010

Bill of materials, CC2400DB Voltage regulator section			
Reference	Description	Value	Part
C401	Capacitor 1206	2.2 uF, 10%	C_2U2_1206_X7R_K_10
C402	Capacitor 1206	2.2 uF, 10%	C_2U2_1206_X7R_K_10
C403	Capacitor 0603	33 nF, 10%	C_33N_0603_X7R_K_25
C404	Capacitor 0603	100 nF, 10%	C_100N_0603_X7R_K_50
C405	Capacitor 1206	2.2 uF, 10%	C_2U2_1206_X7R_K_10
D1	Schottkey diode, 2A		20BQ030
P7	9V battery connector (positive)		CONN_9V_POS
P8	9V battery connector (negative)		CONN_9V_NEG
U4	3.3V low drop-out regulator		LP2981IM5-3.3
U6	1.8V low drop-out regulator		XC6204B182MR

Bill of materials, CC2400DB RS-232 section			
Reference	Description	Value	Part
C501	Capacitor 0603	100 nF, 10%	C_100N_0603_X7R_K_50
C502	Capacitor 0603	100 nF, 10%	C_100N_0603_X7R_K_50
C503	Capacitor 0603	100 nF, 10%	C_100N_0603_X7R_K_50
C504	Capacitor 0603	33 nF, 10%	C_33N_0603_X7R_K_25
C505	Capacitor Low Impedance	470 uF	C_470U_8_CVAX
C506	Capacitor 1206	2.2 uF, 10%	C_2U2_1206_X7R_K_10
C507	Capacitor 0603	100 nF, 10%	C_100N_0603_X7R_K_50
U101	RS-232 Transceiver, 3-5V		MAX3243CWI

**Table 4: Bill of materials**

## Using the CC2400DB Demonstration Board

The CC2400DB Demonstration Board is designed to be useful for quick prototyping, and also for quick practical evaluation such as range testing.

Software can be programmed into the AVR microcontroller either using an external programmer such as the AVRISP programmer or using the serial port to communicate with the boot loader that is programmed into the MCU when the CC2400DB is shipped from the factory. If the boot loader is overwritten when using an external programmer, the AVR must be re-programmed with the boot loader before it is possible to program the AVR via the serial port again.

When shipped from the factory, the CC2400DB contains the boot loader and a simple example that will transmit a packet when a button is pressed, and blink a LED when a packet is received. This example is ideal for range testing, for instance.

### CC2400 Software download and evaluation using AVR Studio 4

Use a serial cable connecting the serial interface of the CC2400DB to the serial port of a PC running AVR Studio and SmartRF<sup>®</sup> Studio. You can then use SmartRF<sup>®</sup> Studio to find all the RF parameters for the CC2400 and AVR Studio 4 to control the CC2400DB, development board.

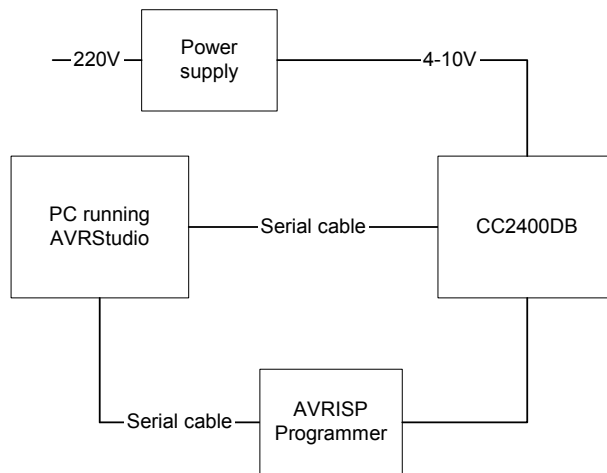
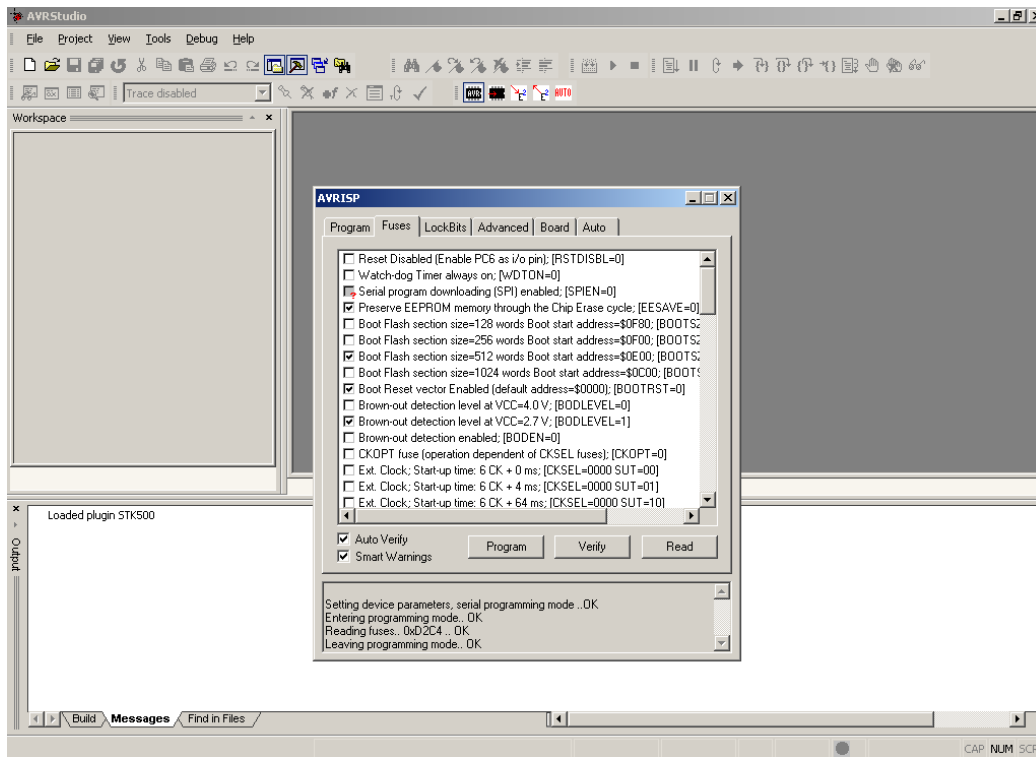

**Figure 12: Software download using AVR Studio 4**

The CC2400DB demonstration board can be used for application software development. To download new application examples a PC must be communicating with CC2400DB running AVR Studio. AVR Studio can be downloaded free of charge from the world-wide-web.

The configuration of the processor fuses is only performed through the SPI interface using the AVRISP programmer and AVR Studio 4. The AVRISP fuse window is depicted in figure 13. The CC2400DB is configured with the following fuses enabled:

1. Boot Flash section size = 512 words Boot start address=\$0E00;[BOOTSZ=01]
2. Brown out detection level at VCC = 2.7 V
3. Internal RC oscillator at 8 MHz Start up time 6CK + 0 ms
4. Preserve EEPROM memory through the Chip Erase Cycle
5. Boot vector enabled (default address = \$0000)



**Figure 13: AVR Studio AVRISP Fuses Window**

### RC oscillator

The internal RC oscillator is used as reference time base. The oscillator frequency is relatively independent of temperature and operating voltage. Its nominal frequency is 8 MHz. A calibration feature utilising a calibration word programmed into the microcontroller at the factory ensures that the oscillator frequency is equal from unit to unit. The calibration value is stored at a fixed location in the EEPROM of the processor.

### Microcontroller EEPROM mapping

The following map shows the data location. To customize the CC2400DB for a different frequency, the EEPROM data can be replaced by new values found using the calibration software. Please contact Chipcon Technical Support.

Note:

If a different RC oscillator frequency is used, a new calibration must be performed for the desired frequency and stored at the correct location in EEPROM. The bootloader uses the RS-232, so by changing the frequency the bootloader must be reprogrammed with the correct baud setting for the frequency of choice. Please contact Chipcon Technical Support

EEPROM Address (hex)	Data	Reference	Comment
0x01FF	Calibration Value		Calibration value is only for 8 MHz

**Table 5: EEPROM memory map**

**In System Programming**

Using the AVRISP in-circuit programmer or similar devices, the microcontroller can be reprogrammed. The program code memory (flash) and the EEPROM can be reprogrammed.

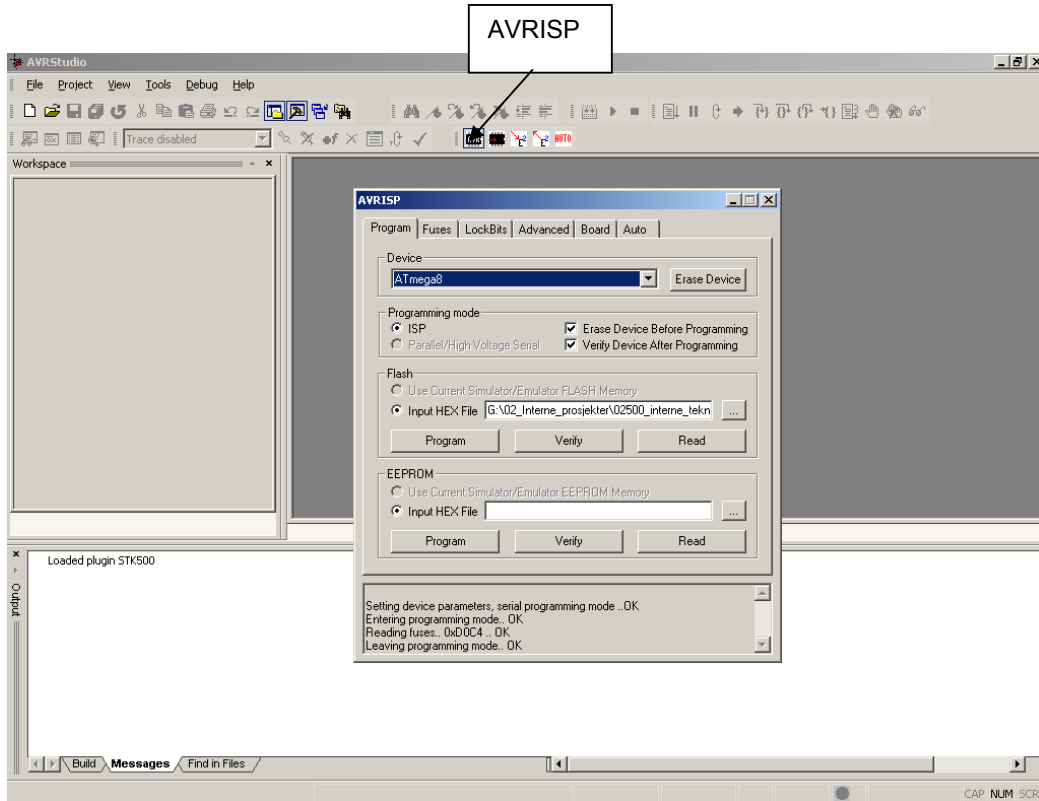

**Figure 14: AVRISP Program Window used to program flash or EEPROM**

The device used for programming must be connected to the CC2400DB programming socket. The programming interface uses 4 signal lines. These four lines can be accessed at the 6-pin connector, P6. The pin out and description is listed in the table 5.

Signal/pin	AVR programming socket, pin
MISO	1
SCK	3
MOSI	4
RESET	5
VCC	2
GND	6



**Table 6: ISP header connector**

### Bootloader

The CC2400DB is shipped with a bootloader. This loader communicates with AVR Studio. After reset the bootloader must have a way to determine to start program mode or to run the application software residing in the application code section of the flash. To start the bootloader the Joystick center push on CC2400DB is used to enter program mode. This button is held low after reset while starting the AVR Prog from the Tools menu in AVR Studio until the bootloader program window is loaded. See figure 15 and 16.

Step-by-Step procedure:

1. Connect the CC2400DB serial port to your PC COM port
2. Connect power to CC2400DB
3. Start AVR Studio
4. Select Tools from the menu (See figure 15)
5. Reset CC2400DB and hold the Joystick Center push button down after reset and start AVR Prog, bootloader will start (See figure 16)
6. Browse to find your application program \*.hex file
7. Click on the Flash Program to program the flash

**Important note:**

*If you should program the EEPROM please contact Chipcon Technical Support*

8. Disconnect serial port
9. Reset CC2400DB
10. Start your application program

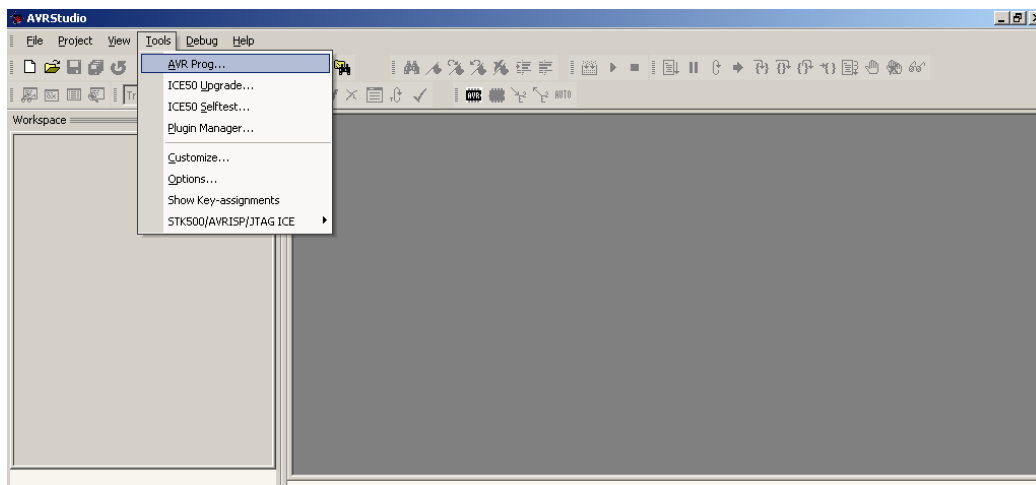

**Figure 15: Starting AVR Prog in AVR Studio**

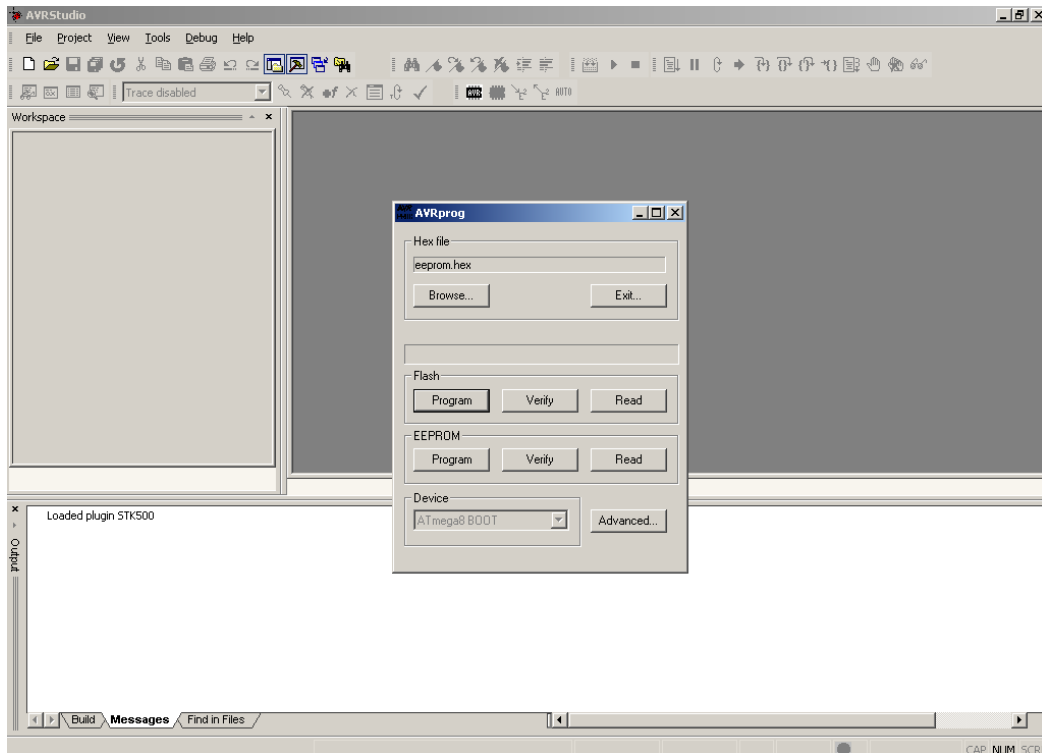

**Figure 16: AVRprog bootloader Window**

In the bootloader window the user can browse to the location of his application program and program the application code section of the flash with the new application. After programming is successful, reset the processor and the application code will start.

**Important:**

*If the AVRISP programmer is used to program examples, the bootloader will be deleted if no protection mode is applied to this section of the processor flash. The bootloader is modified source code from ATMEL AVR application note AVR109, Self programming and compiled with IAR Embedded Workbench.*

**Introduction to examples provided with CC2400DB**

The CC2400 Development Environment for the development of CC2400 software applications is a combination of three tools, a text editor of choice e.g. (UltraEdit-32), a compiler/assembler/linker and software platform provided by the processor manufacturer. The CC2400 Development Environment is based on the “WinAVR”, which is a software development tool. The WinAVR (pronounced “whenever”) is a suite of open source software development tools for the Atmel AVR series of RISC microprocessors for the Windows platform. It includes the GCC compiler for C and C++. This tool provides a framework for most of the features supported by the Atmega8 microcontroller used with the CC2400DB Demonstration Board.

The text editor of choice is primarily a tool for editing C source, assembler and make files. However, it also provides syntax highlighting and other helpful functionality, such as a GUI with possibility of project management, and C function highlighting.

Since the compiler/assembler/linker is integrated into another tool the text editor must be configured with macros to support the make file provide with the for GCC compiler. More

specifically the compiler converts one or more C source files into assembly code, which, together with any handwritten assembler files are fed to the assembler. The assembler then produces object files (machine code and binary data), which in turn are fed into the linker together with the libraries and include files. Finally, the linker isolates functions and variables that are actually used and produces an executable file in Intel HEX format that can be downloaded into the FLASH memory of the Atmega8 microcontroller

### Setting up a software project for CC2400

Before the CC2400 Development Environment can generate any target software it needs a software project with consistent references to the actual target platform files is needed. These references can be specified in the target project workspace of your text editor. See figure 17.

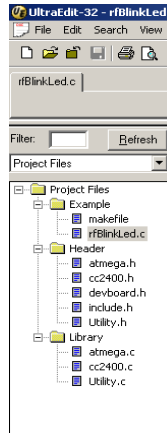

**Figure 17: Software project workspace**

### Hardware Definition Files (HDF)

The hardware definition files (include files) define the hardware registers, interrupt vector mapping and other hardware constants. They also include useful macros for the CC2400DB, and all definitions generally support the C language.

The following files are included as hardware definition files,

- atmega.h
- CC2400.h
- devboard.h
- Utility.h

### Hardware Library Files (HLF)

To support quick and easy program development Chipcon provides a library of macros and functions that simplify hardware access to the CC2400 and the processor on the CC2400DB. The files implement a hardware abstraction interface for the user program. As a result the user program can access the e.g. microcontroller peripherals via function/macro calls without specific knowledge about the hardware details

The following files are included as hardware library files,

- atmega.c
- CC2400.c

- Utility.c

### Configure output profile

The CC2400 Development Environment “build process” generates an executable file according to the settings specified in the make file provided with the application examples and by using the macros configured in the text editor. To support the processor target the output file must be in the correct format.

With CC2400DB an RF link example is provided in the application code section of the processor flash. The example is called rfBlinkLed. The application program is controlled by the same push button as the bootloader, S2. See schematic layout for location of the button on the PCB. Instead of powering up the board with the bootloader the board should be powered up with the application code. The CC2400 is configured with default settings, buffered mode, and a data rate of 1 Mbps.

Use the S2 push button to start the application. You will see that if you have no receiver up and running the red LED will start to toggle. This means that you are not receiving acknowledge form the receiver and thus have no link.

### Data packet description

The data packet consists of a preamble, synchronization word, length byte, flag byte and a data field. The length byte, flag byte and a fixed 10-byte payload are inserted by the application.

The preamble, synchronization word and CRC is generated and inserted in the package by CC2400. The data packet is shown in the figure 18.

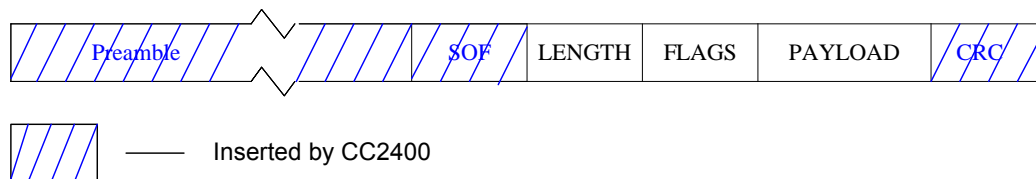
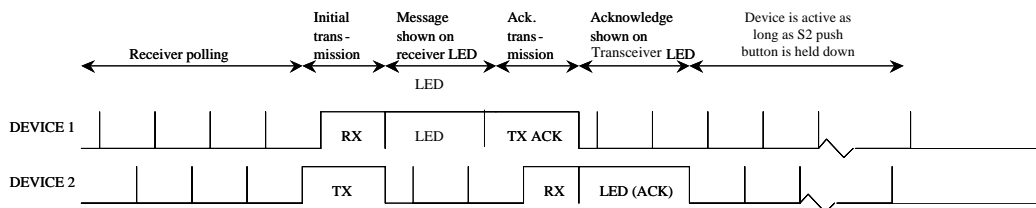

**Figure 18 The data packet used in the rfBlinkLed example**

### Data transmission protocol

The data transmission protocol is very simple, only using packet acknowledgement (ACK).

When the receiver receives a data package, the packet type is checked for CRC. If the message is OK, it is shown on the green receiver LED, and an acknowledgement is sent as a reply. However, if an acknowledgement packet that is received by the transceiver originally transmitting, receipt of the ACK is indicated on the yellow LED without any further reply. If no acknowledgement is received the red LED will toggle.



**Figure 19 Data Transmission Protocol**

## Troubleshooting

### It does not work

- Make sure that the power supply is connected to the correct pins on the power connector.
- Is the supply voltage correctly polarized? If not, the protection diode will prevent any current from flowing. + and – are indicated on the PCB. On the DC jack, the tip is + and the ring is –.

### I cannot program the AVR using the serial port

- If you have programmed the AVR using an external programmer, you must use an external programmer to program the AVR with the bootloader before you can use the serial port to program the AVR again.

## References

CC2400 Datasheet

Atmel Application note: AVR109 Self-programming (Bootloader for CC2400DBK is based on this application note)

[http://www.atmel.com/dyn/general/tech\\_doc.asp?doc\\_id=8053](http://www.atmel.com/dyn/general/tech_doc.asp?doc_id=8053)

AVR Studio:

<http://www.avrfreaks.net/Home/News/article.php?NewsID=457>

Or

[http://www.atmel.com/dyn/products/tools.asp?family\\_id=607](http://www.atmel.com/dyn/products/tools.asp?family_id=607)

WINAVR / AVR GCC:

<http://www.avrfreaks.net/AVRGCC/index.php>

## Document History

Revision	Date	Description/Changes
1.0	08.01.2004	Initial release.
1.1	28.01.2004	Cosmetic and bootloader section changes
1.2	13.02.2004	Minor BOM and layout change on CC2400DB

### Address Information

Web site: <http://www.chipcon.com>  
E-mail: [wireless@chipcon.com](mailto:wireless@chipcon.com)  
Technical Support E-mail: [support@chipcon.com](mailto:support@chipcon.com)  
Technical Support Hotline: +47 22 95 85 45

### Headquarters:

Chipcon AS  
Gaustadalléen 21  
NO-0349 Oslo  
NORWAY  
Tel: +47 22 95 85 44  
Fax: +47 22 95 85 46  
E-mail: [wireless@chipcon.com](mailto:wireless@chipcon.com)

### US Offices:

Chipcon Inc., Western US Sales Office  
19925 Stevens Creek Blvd.  
Cupertino, CA 95014-2358  
USA  
Tel: +1 408 973 7845  
Fax: +1 408 973 7257  
Email: [USsales@chipcon.com](mailto:USsales@chipcon.com)

Chipcon Inc., Eastern US Sales Office  
35 Pinehurst Avenue  
Nashua, New Hampshire, 03062  
USA  
Tel: +1 603 888 1326  
Fax: +1 603 888 4239  
Email: [eastUSSales@chipcon.com](mailto:eastUSSales@chipcon.com)

### Sales Office Germany:

Chipcon AS  
Riedberghof 3  
D-74379 Ingersheim  
GERMANY  
Tel: +49 7142 9156815  
Fax: +49 7142 9156818  
Email: [Germanysales@chipcon.com](mailto:Germanysales@chipcon.com)

Chipcon AS (Strategic Automotive Center)  
Hechtseestrasse 16  
D-83022 Rosenheim  
Germany  
Tel: +49 8031 2227 660  
Mobile: +49 172 8540 132  
Fax: +49 8031 2227 661  
Email: [automotive@chipcon.com](mailto:automotive@chipcon.com)

### Sales Office Asia :

Chipcon Asia Pasific  
37F, Asem Tower  
159-1 Samsung-dong, Kangnam-ku  
Seoul 135-798 Korea  
Tel: +82 2 6001 3888  
Fax: +82 2 6001 3711  
Email: [Asiasales@chipcon.com](mailto:Asiasales@chipcon.com)