

UAA2016

Zero Voltage Switch Power Controller

The UAA2016 is designed to drive triacs with the Zero Voltage technique which allows RFI-free power regulation of resistive loads. Operating directly on the AC power line, its main application is the precision regulation of electrical heating systems such as panel heaters or irons.

A built-in digital sawtooth waveform permits proportional temperature regulation action over a $\pm 1^\circ\text{C}$ band around the set point. For energy savings there is a programmable temperature reduction function, and for security a sensor failsafe inhibits output pulses when the sensor connection is broken. Preset temperature (i.e. defrost) application is also possible. In applications where high hysteresis is needed, its value can be adjusted up to 5°C around the set point. All these features are implemented with a very low external component count.

- Zero Voltage Switch for Triacs, up to 2.0 kW (MAC212A8)
- Direct AC Line Operation
- Proportional Regulation of Temperature over a 1°C Band
- Programmable Temperature Reduction
- Preset Temperature (i.e. Defrost)
- Sensor Failsafe
- Adjustable Hysteresis
- Low External Component Count

ZERO VOLTAGE SWITCH POWER CONTROLLER

SEMICONDUCTOR TECHNICAL DATA

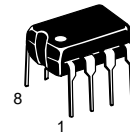

P SUFFIX
PLASTIC PACKAGE
CASE 626



D SUFFIX
PLASTIC PACKAGE
CASE 751
(SO-8)

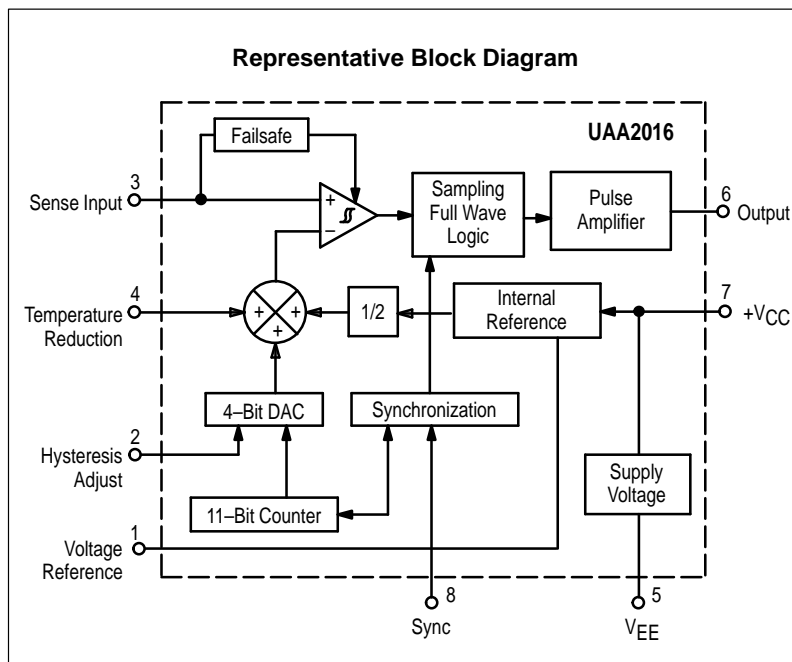

PIN CONNECTIONS

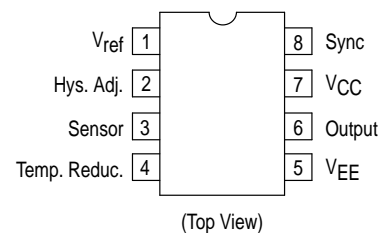

ORDERING INFORMATION

Device	Operating Temperature Range	Package
UAA2016D	$T_A = -20^\circ$ to $+85^\circ\text{C}$	SO-8
UAA2016P		Plastic DIP

UAA2016

MAXIMUM RATINGS (Voltages referenced to Pin 7)

Rating	Symbol	Value	Unit
Supply Current (I _{Pin 5})	I _{CC}	15	mA
Non-Repetitive Supply Current (Pulse Width = 1.0 μs)	I _{CCP}	200	mA
AC Synchronization Current	I _{sync}	3.0	mA
Pin Voltages	V _{Pin 2} V _{Pin 3} V _{Pin 4} V _{Pin 6}	0; V _{ref} 0; V _{ref} 0; V _{ref} 0; V _{EE}	V
V _{ref} Current Sink	I _{Pin 1}	1.0	mA
Output Current (Pin 6) (Pulse Width < 400 μs)	I _O	150	mA
Power Dissipation	P _D	625	mW
Thermal Resistance, Junction-to-Air	R _{θJA}	100	°C/W
Operating Temperature Range	T _A	- 20 to + 85	°C

ELECTRICAL CHARACTERISTICS (T_A = 25°C, V_{EE} = -7.0 V, voltages referred to Pin 7, unless otherwise noted.)

Characteristic	Symbol	Min	Typ	Max	Unit
Supply Current (Pins 6, 8 not connected) (T _A = - 20° to + 85°C)	I _{CC}	—	0.9	1.5	mA
Stabilized Supply Voltage (Pin 5) (I _{CC} = 2.0 mA)	V _{EE}	-10	- 9.0	- 8.0	V
Reference Voltage (Pin 1)	V _{ref}	- 6.5	- 5.5	- 4.5	V
Output Pulse Current (T _A = - 20° to + 85°C) (R _{out} = 60 W, V _{EE} = - 8.0 V)	I _O	90	100	130	mA
Output Leakage Current (V _{out} = 0 V)	I _{OL}	—	—	10	μA
Output Pulse Width (T _A = - 20° to + 85°C) (Note 1) (Mains = 220 V _{rms} , R _{sync} = 220 kΩ)	T _P	50	—	100	μs
Comparator Offset (Note 5)	V _{off}	-10	—	+10	mV
Sensor Input Bias Current	I _{IB}	—	—	0.1	μA
Sawtooth Period (Note 2)	T _S	—	40.96	—	sec
Sawtooth Amplitude (Note 6)	A _S	50	70	90	mV
Temperature Reduction Voltage (Note 3) (Pin 4 Connected to V _{CC})	V _{TR}	280	350	420	mV
Internal Hysteresis Voltage (Pin 2 Not Connected)	V _{IH}	—	10	—	mV
Additional Hysteresis (Note 4) (Pin 2 Connected to V _{CC})	V _H	280	350	420	mV
Failsafe Threshold (T _A = - 20° to + 85°C) (Note 7)	V _{FStH}	180	—	300	mV

- NOTES:**
- Output pulses are centered with respect to zero crossing point. Pulse width is adjusted by the value of R_{sync}. Refer to application curves.
 - The actual sawtooth period depends on the AC power line frequency. It is exactly 2048 times the corresponding period. For the 50 Hz case it is 40.96 sec. For the 60 Hz case it is 34.13 sec. This is to comply with the European standard, namely that 2.0 kW loads cannot be connected or removed from the line more than once every 30 sec.
 - 350 mV corresponds to 5°C temperature reduction. This is tested at probe using internal test pad. Smaller temperature reduction can be obtained by adding an external resistor between Pin 4 and V_{CC}. Refer to application curves.
 - 350 mV corresponds to a hysteresis of 5°C. This is tested at probe using internal test pad. Smaller additional hysteresis can be obtained by adding an external resistor between Pin 2 and V_{CC}. Refer to application curves.
 - Parameter guaranteed but not tested. Worst case 10 mV corresponds to 0.15°C shift on set point.
 - Measured at probe by internal test pad. 70 mV corresponds to 1°C. Note that the proportional band is independent of the NTC value.
 - At very low temperature the NTC resistor increases quickly. This can cause the sensor input voltage to reach the failsafe threshold, thus inhibiting output pulses; refer to application schematics. The corresponding temperature is the limit at which the circuit works in the typical application. By setting this threshold at 0.05 V_{ref}, the NTC value can increase up to 20 times its nominal value, thus the application works below - 20°C.

Figure 1. Application Schematic

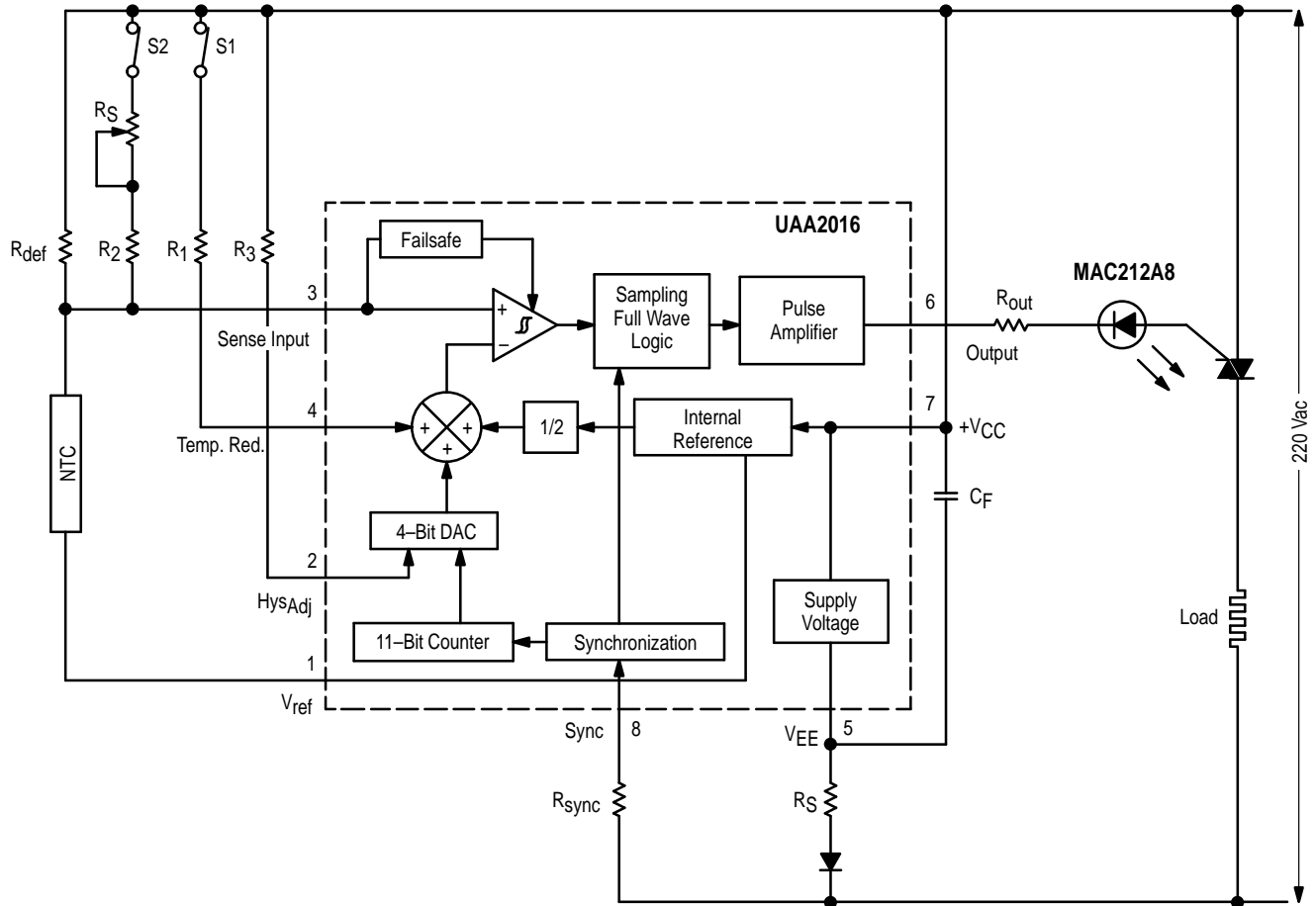

APPLICATION INFORMATION

(For simplicity, the LED in series with R_{out} is omitted in the following calculations.)

Triac Choice and R_{out} Determination

Depending on the power in the load, choose the triac that has the lowest peak gate trigger current. This will limit the output current of the UAA2016 and thus its power consumption. Use Figure 4 to determine R_{out} according to the triac maximum gate current (I_{GT}) and the application low temperature limit. For a 2.0 kW load at 220 Vrms, a good triac choice is the Motorola MAC212A8. Its maximum peak gate trigger current at 25°C is 50 mA.

For an application to work down to -20°C, R_{out} should be 60 Ω. It is assumed that: $I_{GT}(T) = I_{GT}(25°C) \times \exp(-T/125)$ with T in °C, which applies to the MAC212A8.

Output Pulse Width, R_{sync}

The pulse with T_p is determined by the triac's I_{Hold} , I_{Latch} together with the load value and working conditions (frequency and voltage):

Given the RMS AC voltage and the load power, the load value is:

$$R_L = \sqrt{2} \text{rms} / \text{POWER}$$

The load current is then:

$$I_{Load} = (V_{rms} \times \sqrt{2} \times \sin(2\pi ft) - V_{TM}) / R_L$$

where V_{TM} is the maximum on state voltage of the triac, f is the line frequency.

Set $I_{Load} = I_{Latch}$ for $t = T_p/2$ to calculate T_p .

Figures 6 and 7 give the value of T_p which corresponds to the higher of the values of I_{Hold} and I_{Latch} , assuming that $V_{TM} = 1.6$ V. Figure 8 gives the R_{sync} that produces the corresponding T_p .

R_{Supply} and Filter Capacitor

With the output current and the pulse width determined as above, use Figures 9 and 10 to determine R_{Supply} , assuming that the sinking current at V_{ref} pin (including NTC bridge current) is less than 0.5 mA. Then use Figure 11 and 12 to determine the filter capacitor (C_F) according to the ripple desired on supply voltage. The maximum ripple allowed is 1.0 V.

Temperature Reduction Determined by R_1

(Refer to Figures 13 and 14.)

Figure 2. Comparison Between Proportional Control and ON/OFF Control

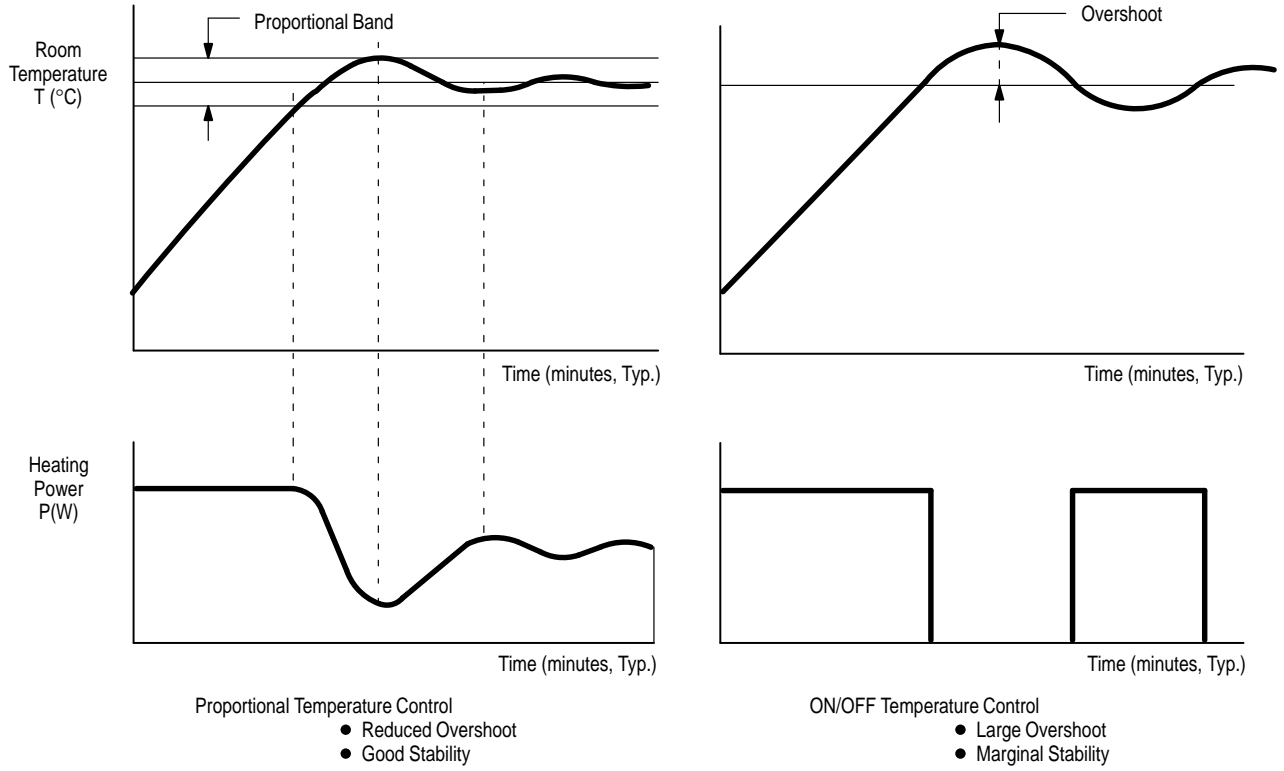
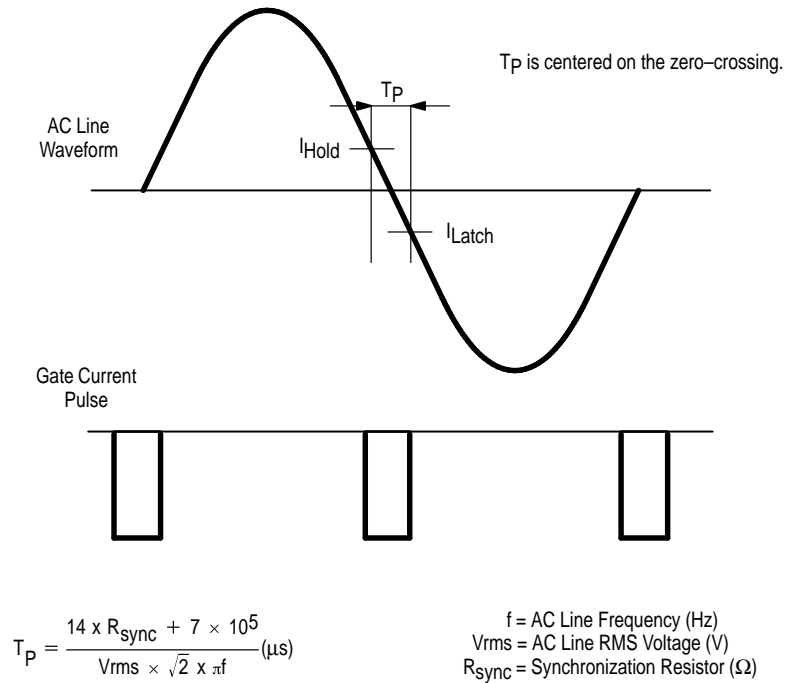

Figure 3. Zero Voltage Technique



CIRCUIT FUNCTIONAL DESCRIPTION

Power Supply (Pin 5 and Pin 7)

The application uses a current source supplied by a single high voltage rectifier in series with a power dropping resistor. An integrated shunt regulator delivers a V_{EE} voltage of -8.6 V with respect to Pin 7. The current used by the total regulating system can be shared in four functional blocks: IC supply, sensing bridge, triac gate firing pulses and zener current. The integrated zener, as in any shunt regulator, absorbs the excess supply current. The 50 Hz pulsed supply current is smoothed by the large value capacitor connected between Pins 5 and 7.

Temperature Sensing (Pin 3)

The actual temperature is sensed by a negative temperature coefficient element connected in a resistor divider fashion. This two element network is connected between the ground terminal Pin 5 and the reference voltage -5.5 V available on Pin 1. The resulting voltage, a function of the measured temperature, is applied to Pin 3 and internally compared to a control voltage whose value depends on several elements: Sawtooth, Temperature Reduction and Hysteresis Adjust. (Refer to Application Information.)

Temperature Reduction

For energy saving, a remotely programmable temperature reduction is available on Pin 4. The choice of resistor R_1 connected between Pin 4 and V_{CC} sets the temperature reduction level.

Comparator

When the positive input (Pin 3) receives a voltage greater than the internal reference value, the comparator allows the triggering logic to deliver pulses to the triac gate. To improve the noise immunity, the comparator has an adjustable hysteresis. The external resistor R_3 connected to Pin 2 sets the hysteresis level. Setting Pin 2 open makes a 10 mV hysteresis level, corresponding to 0.15°C . Maximum hysteresis is obtained by connecting Pin 2 to V_{CC} . In that

case the level is set at 5°C . This configuration can be useful for low temperature inertia systems.

Sawtooth Generator

In order to comply with European norms, the ON/OFF period on the load must exceed 30 seconds. This is achieved by an internal digital sawtooth which performs the proportional regulation without any additional component. The sawtooth signal is added to the reference applied to the comparator negative input. Figure 2 shows the regulation improvement using the proportional band action.

Noise Immunity

The noisy environment requires good immunity. Both the voltage reference and the comparator hysteresis minimize the noise effect on the comparator input. In addition the effective triac triggering is enabled every 1/3 sec.

Failsafe

Output pulses are inhibited by the "failsafe" circuit if the comparator input voltage exceeds the specified threshold voltage. This would occur if the temperature sensor circuit is open.

Sampling Full Wave Logic

Two consecutive zero-crossing trigger pulses are generated at every positive mains half-cycle. This ensures that the number of delivered pulses is even in every case. The pulse length is selectable by R_{SYNC} connected on Pin 8. The pulse is centered on the zero-crossing mains waveform.

Pulse Amplifier

The pulse amplifier circuit sinks current pulses from Pin 6 to V_{EE} . The minimum amplitude is 70 mA. The triac is then triggered in quadrants II and III. The effective output current amplitude is given by the external resistor R_{OUT} . Eventually, an LED can be inserted in series with the Triac gate (see Figure 1).

Figure 4. Output Resistor versus Triac Gate Current

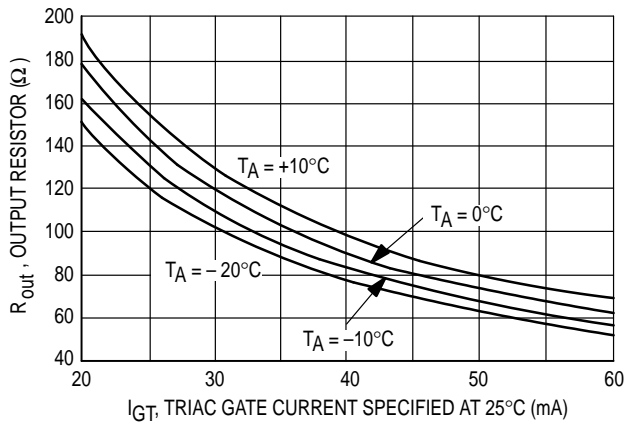

Figure 5. Minimum Output Current versus Output Resistor

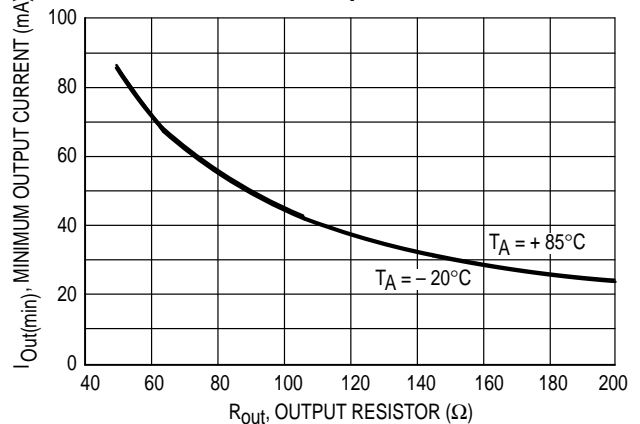

Figure 6. Output Pulse Width versus Maximum Triac Latch Current

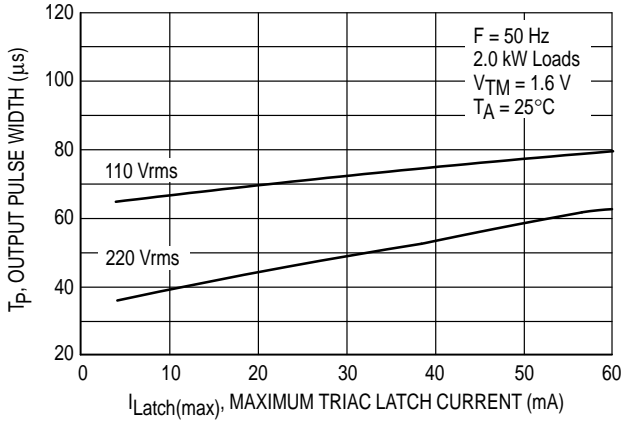

Figure 7. Output Pulse Width versus Maximum Triac Latch Current

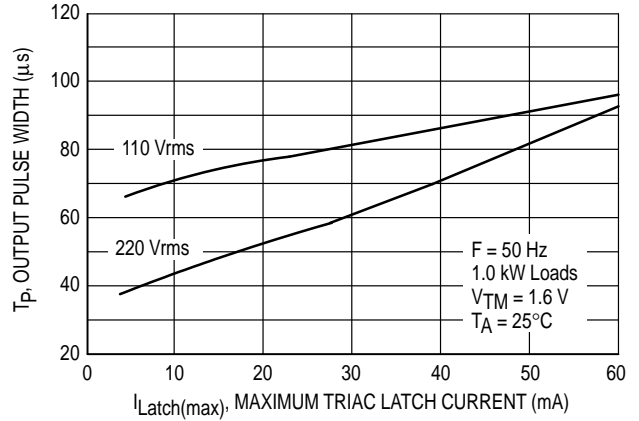

Figure 8. Synchronization Resistor versus Output Pulse Width

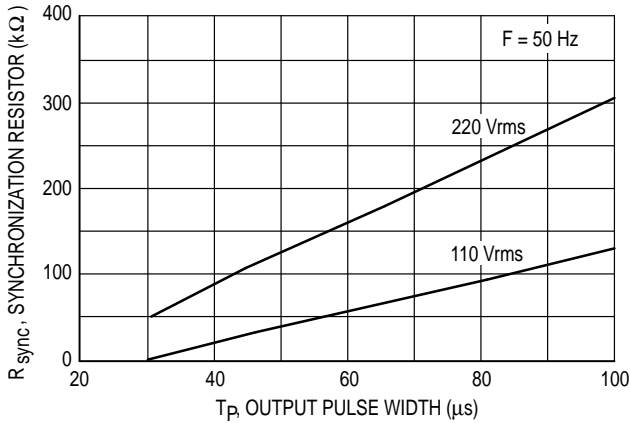

Figure 9. Maximum Supply Resistor versus Output Current

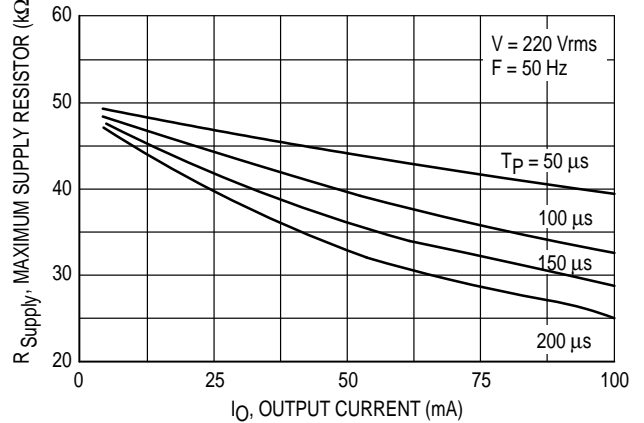

Figure 10. Maximum Supply Resistor versus Output Current

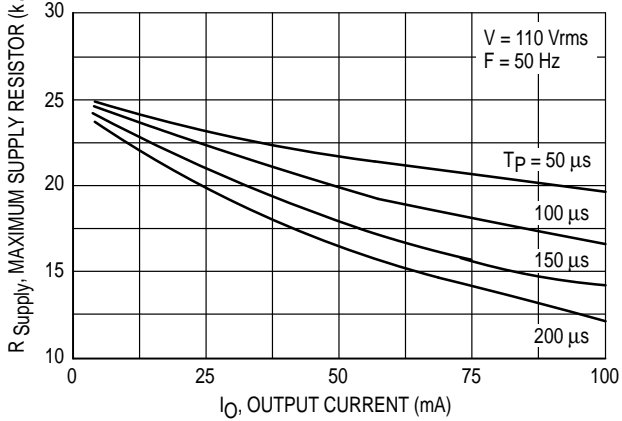

Figure 11. Minimum Filter Capacitor versus Output Current

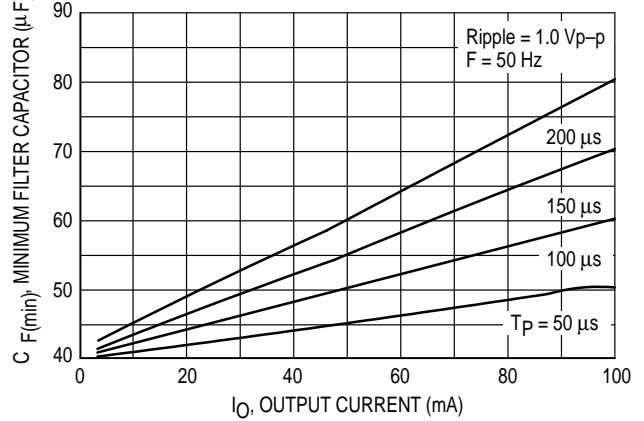

Figure 12. Minimum Filter Capacitor versus Output Current

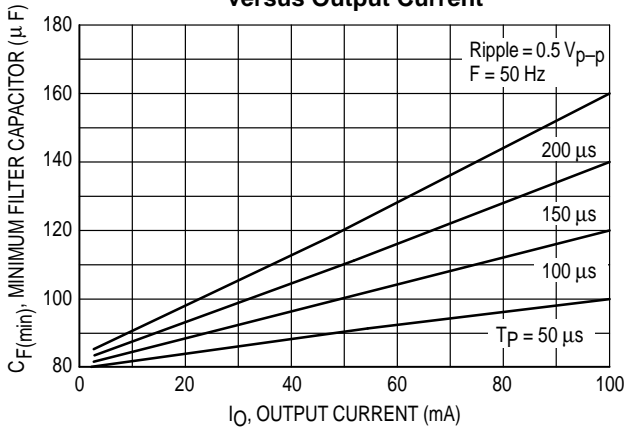

Figure 13. Temperature Reduction versus R_1

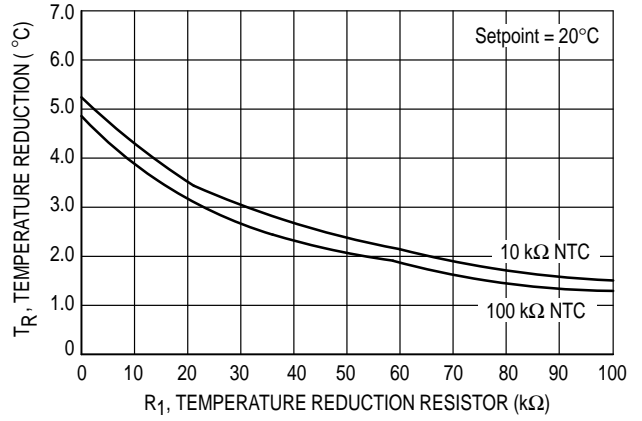

Figure 14. Temperature Reduction versus Temperature Setpoint

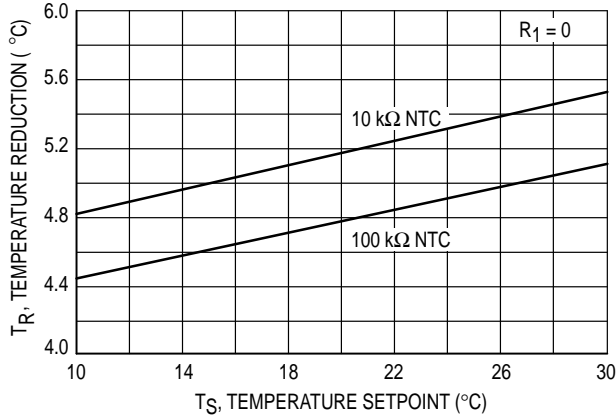

Figure 15. R_{DEF} versus Preset Temperature

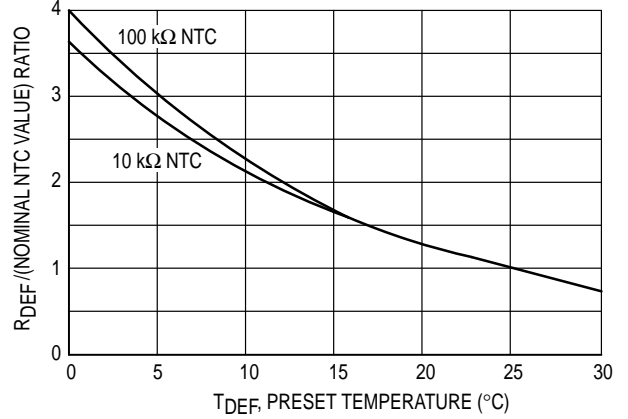

Figure 16. $R_S + R_2$ versus Preset Setpoint

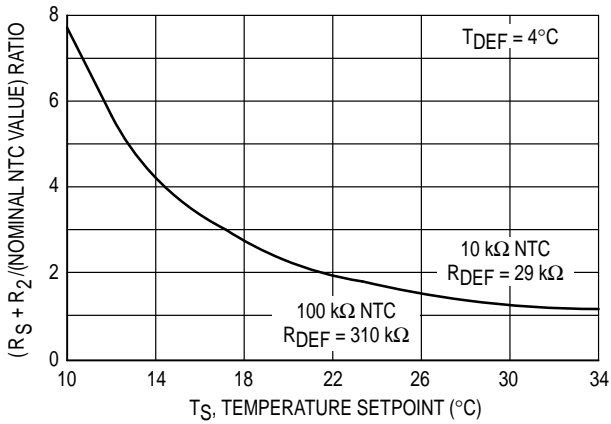
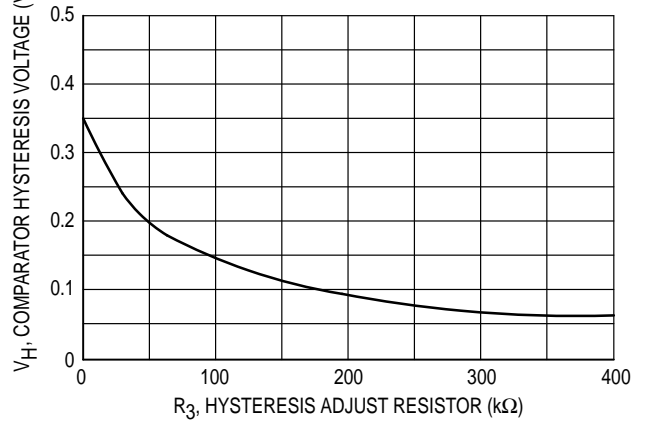

Figure 17. Comparator Hysteresis versus R_3



UAA2016

OUTLINE DIMENSIONS

P SUFFIX
PLASTIC PACKAGE
CASE 626-05
ISSUE K

NOTES:

1. DIMENSION L TO CENTER OF LEAD WHEN FORMED PARALLEL.
2. PACKAGE CONTOUR OPTIONAL (ROUND OR SQUARE CORNERS).
3. DIMENSIONING AND TOLERANCING PER ANSI Y14.5M, 1982.

DIM	MILLIMETERS		INCHES	
	MIN	MAX	MIN	MAX
A	9.40	10.16	0.370	0.400
B	6.10	6.60	0.240	0.260
C	3.94	4.45	0.155	0.175
D	0.38	0.51	0.015	0.020
F	1.02	1.78	0.040	0.070
G	2.54 BSC		0.100 BSC	
H	0.76	1.27	0.030	0.050
J	0.20	0.30	0.008	0.012
K	2.92	3.43	0.115	0.135
L	7.62 BSC		0.300 BSC	
M			10°	10°
N	0.76	1.01	0.030	0.040

\oplus	$\varnothing 0.13 (0.005)$	\textcircled{M}	T	A	\textcircled{M}	B	\textcircled{M}
----------	----------------------------	-------------------	---	---	-------------------	---	-------------------

D SUFFIX
PLASTIC PACKAGE
CASE 751-05
ISSUE N
(SO-8)

NOTES:

1. DIMENSIONING AND TOLERANCING PER ANSI Y14.5M, 1982.
2. CONTROLLING DIMENSION: MILLIMETER.
3. DIMENSIONS A AND B DO NOT INCLUDE MOLD PROTRUSION.
4. MAXIMUM MOLD PROTRUSION 0.15 (0.006) PER SIDE.
5. DIMENSION D DOES NOT INCLUDE DAMBAR PROTRUSION. ALLOWABLE DAMBAR PROTRUSION SHALL BE 0.127 (0.005) TOTAL IN EXCESS OF THE D DIMENSION AT MAXIMUM MATERIAL CONDITION.

DIM	MILLIMETERS		INCHES	
	MIN	MAX	MIN	MAX
A	4.80	5.00	0.189	0.196
B	3.80	4.00	0.150	0.157
C	1.35	1.75	0.054	0.068
D	0.35	0.49	0.014	0.019
F	0.40	1.25	0.016	0.049
G	1.27 BSC		0.050 BSC	
J	0.18	0.25	0.007	0.009
K	0.10	0.25	0.004	0.009
M			0°	7°
P	5.80	6.20	0.229	0.244
R	0.25	0.50	0.010	0.019

\oplus	0.25 (0.010)	\textcircled{M}	T	B	\textcircled{S}	A	\textcircled{S}
----------	--------------	-------------------	---	---	-------------------	---	-------------------

Motorola reserves the right to make changes without further notice to any products herein. Motorola makes no warranty, representation or guarantee regarding the suitability of its products for any particular purpose, nor does Motorola assume any liability arising out of the application or use of any product or circuit, and specifically disclaims any and all liability, including without limitation consequential or incidental damages. "Typical" parameters which may be provided in Motorola data sheets and/or specifications can and do vary in different applications and actual performance may vary over time. All operating parameters, including "Typicals" must be validated for each customer application by customer's technical experts. Motorola does not convey any license under its patent rights nor the rights of others. Motorola products are not designed, intended, or authorized for use as components in systems intended for surgical implant into the body, or other applications intended to support or sustain life, or for any other application in which the failure of the Motorola product could create a situation where personal injury or death may occur. Should Buyer purchase or use Motorola products for any such unintended or unauthorized application, Buyer shall indemnify and hold Motorola and its officers, employees, subsidiaries, affiliates, and distributors harmless against all claims, costs, damages, and expenses, and reasonable attorney fees arising out of, directly or indirectly, any claim of personal injury or death associated with such unintended or unauthorized use, even if such claim alleges that Motorola was negligent regarding the design or manufacture of the part. Motorola and are registered trademarks of Motorola, Inc. Motorola, Inc. is an Equal Opportunity/Affirmative Action Employer.

Mfax is a trademark of Motorola, Inc.

How to reach us:

USA/EUROPE/Locations Not Listed: Motorola Literature Distribution;
P.O. Box 5405, Denver, Colorado 80217. 1-303-675-2140 or 1-800-441-2447

JAPAN: Motorola Japan Ltd.; SPD, Strategic Planning Office, 141,
4-32-1 Nishi-Gotanda, Shinagawa-ku, Tokyo, Japan. 81-3-5487-8488

Customer Focus Center: 1-800-521-6274

Mfax™: RMFAX0@email.sps.mot.com – TOUCHTONE 1-602-244-6609
Motorola Fax Back System – US & Canada ONLY 1-800-774-1848
– http://sps.motorola.com/mfax/

ASIA/PACIFIC: Motorola Semiconductors H.K. Ltd.; Silicon Harbour Centre,
2, Dai King Street, Tai Po Industrial Estate, Tai Po, N.T., Hong Kong.
852-26629298

HOME PAGE: <http://motorola.com/sps/>

