

# Amphenol

Amphenol-Tuchel Electronics GmbH

## medi|mate<sup>easy</sup> Circular Connectors



connecting life

|mate by Amphenol

## The Company

Amphenol-Tuchel Electronics GmbH is a member of the USA based Amphenol Corporation. With our own global presence we offer our customers exceptional technical support and worldwide service in the areas of development, production and distribution. Amphenol-Tuchel Electronics GmbH has a successful history as a partner to our customers and sets standards for connector technology.

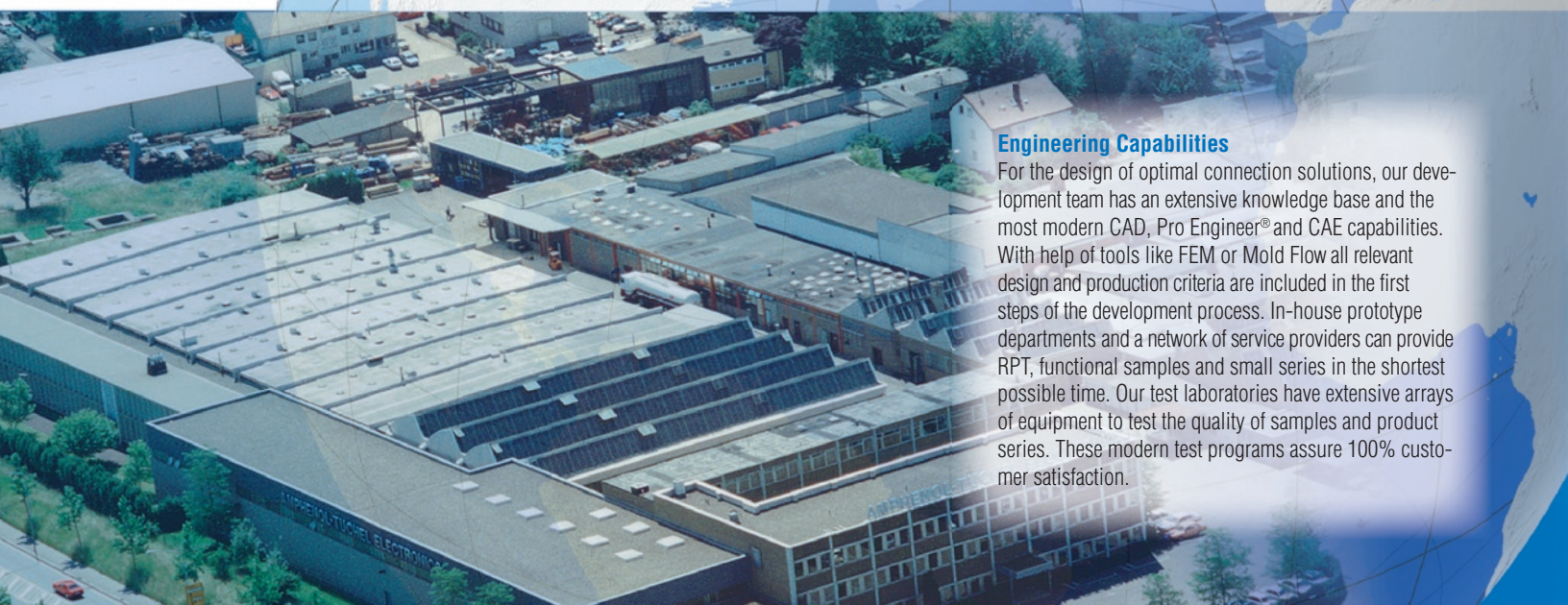

## Engineering Capabilities

For the design of optimal connection solutions, our development team has an extensive knowledge base and the most modern CAD, Pro Engineer® and CAE capabilities. With help of tools like FEM or Mold Flow all relevant design and production criteria are included in the first steps of the development process. In-house prototype departments and a network of service providers can provide RPT, functional samples and small series in the shortest possible time. Our test laboratories have extensive arrays of equipment to test the quality of samples and product series. These modern test programs assure 100% customer satisfaction.

## High-Performance Production

Our production competence enables us to manufacture connectors and cable assemblies to the highest level of quality. According to demand and amount, we have the possibility to manufacture the products using manual, half-automated or fully automated processes in many worldwide facilities. As such, we are in a flexible position to respond to the specific wishes of our customers. Efficient tool production, state of the art molding and overmolding technology, heavy duty stamping as well as high grade test equipment guarantees uniform reliable quality at competitive costs.

## Quality

Meeting customer requirements is the main focus of the product development process, especially in the sensitive field of medical applications. Our quality assessment begins with the initial contact to the customer and extends through the life of the product. A satisfied customer is the measure of our success. Amphenol's quality awareness is oriented on the newest aspects of ISO 9001, QS 9000 and TS 16 949. Additionally our environmental view is oriented on ISO 14 001.

## General information

We reserve the right to change the design due to improvement in quality, development or production requirements.

This catalogue must not be used in any form or manner without our prior approval in writing (Copyright Law, Fair Trading Law, Civil Code).

This release replaces all former releases.

medi|mate<sup>easy</sup> is a registered trademark. Usage or modification is not allowed without written permission of Amphenol-Tuchel.

All dimensions are in mm.

# medi|mate easy



- Easy mating via a Push-Pull interlock
- Small compact design
- Ergonomic handling
- Lightweight and robust plastic housing

## Content

Page

General Information	2										
Product Description	4										
Technical Data	5										
Order Information	6										
Products	<table border="0"> <tr> <td>Male Cable Connectors</td> <td>7</td> </tr> <tr> <td>Female Cable Connectors</td> <td>8</td> </tr> <tr> <td>Male Cable Connectors for Air and Fluid Transmission</td> <td>9</td> </tr> <tr> <td>Female Cable Connectors for Air and Fluid Transmission</td> <td>10</td> </tr> <tr> <td>Female Receptacles</td> <td>11</td> </tr> </table>	Male Cable Connectors	7	Female Cable Connectors	8	Male Cable Connectors for Air and Fluid Transmission	9	Female Cable Connectors for Air and Fluid Transmission	10	Female Receptacles	11
Male Cable Connectors	7										
Female Cable Connectors	8										
Male Cable Connectors for Air and Fluid Transmission	9										
Female Cable Connectors for Air and Fluid Transmission	10										
Female Receptacles	11										
Mounting Instructions	12										
Technical Information	13										
Summary of Part Numbers	15										

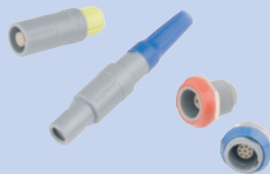



### Product Description

medi|mate<sup>easy</sup> includes circular push pull connectors. In design and conception the medi|mate<sup>easy</sup> program meets the high requirements for medical applications.

#### Typical MEDICAL applications are

- Patient monitoring
- Dental equipment
- Defibrillators
- Handheld operating units
- Intracardiac catheters
- Laboratory equipment
- Electro surgery
- Home diagnostics

#### Additional applications are









- Test and measurement equipment
- Consumer products
- Industrial electronics
- Physiotherapy
- And other medical and non medical applications

#### Advantages

- Extensive life-span - capable of more than 3,000 mating cycles
- Appealing colors
- Sterilizable - special design for easy cleaning and disinfection
- Simple part numbering system in catalogue

#### Features

- Easy mating via a Push-Pull interlock
- Large variation of contact positions, 2-14 position (2, 4, 5, 6, 7, 8, 9, 10, 14 pin inserts)
- Gold plated solder contacts
- Connectors for air and fluid transmission on request
- Lightweight
- Small compact design with excellent electrical characteristics
- Robust plastic housing – using special medical plastics
- Cable and inline mounting options
- Receptacles with front and rear mount options
- Housings incorporating total contact protection
- Polarisation achieved through intelligent color coding and keying system
- Strain relief with optional cable support sleeve
- Intermateable with similar interconnect systems
- Amphenol customer specific cable assemblies
- More than 15 years Amphenol medical know-how e.g. design, material, test and cable assemblies
- Autoclavable on demand

General Characteristics		Standard		Characteristics						
Number of contacts		2	4	5	6	7	8	9	10	14
Male view										
Contact Ø [mm]		1.3	0.9	0.9	0.7	0.7	0.7	0.5	0.5	0.5
Solder bucket Ø [mm]		1.1	0.85	0.85	0.65	0.65	0.65	0.45	0.45	0.45
Max. AWG / mm <sup>2</sup>		20 0.5	22 0.38	22 0.38	26 0.15	26 0.15	26 0.15	28 0.08	28 0.08	28 0.08
<b>Electrical Characteristics</b>										
Insulation resistance [Ω]	IEC 60512-3-1 test 3a	> 10 <sup>10</sup>	> 10 <sup>10</sup>	> 10 <sup>10</sup>	> 10 <sup>10</sup>	> 10 <sup>10</sup>	> 10 <sup>10</sup>	> 10 <sup>10</sup>	> 10 <sup>10</sup>	> 10 <sup>10</sup>
Air clearance min. [mm] <sup>2)</sup>	IEC 60664-1	1.3	1.1	0.8	0.8	0.8	0.6	0.6	0.5	0.5
Creepage distance min. [mm] <sup>2)</sup>	IEC 60664-1	1.3	1.1	0.8	0.8	0.8	0.6	0.6	0.5	0.5
Operating voltage [V rms/dc] <sup>1) 2)</sup>	IEC 60664-1 VDE 0110	500	400	320	320	320	250	250	200	200
Test voltage [kV rms] <sup>2)</sup>	IEC 60512-4-1 test 4a	4.0	2.5	2.5	2.5	2.5	2.5	2.5	1.5	1.5
Rated current [A]	IEC 60512-5-2 test 5b	see derating curves page 12								
Rated current [A] T amb = 45 °C	IEC 60512-5-1 test 5a	9.9	6.5	5.2	3.5	3.0	3.0	2.2	2.2	1.8
<b>Climatic Characteristics</b>										
Operating temperature		- 40°C ... + 100°C <sup>3)</sup>								
Short time operating temperature in unmated condition (e.g. autoclave)		up to + 140°C								
<b>Mechanical Characteristics</b>										
Degree of protection		IP 50								
Strength of strain relief		> 100 N								
Insertion and withdrawal forces (all cavities populated)	IEC 60512-13-2 test 13b	5 to 15 N								
Mechanical operation without corrosion		> 3.000 mating cycles								
<b>Materials</b>										
Housing material plastic		PSU Polysulfon [PEI Polyetherimide on demand]								
Insert material		PEEK Polyetheretherketon								
Contact		brass								
Contact plating		gold plated, min. 0.5 µm gold								
<b>Other Characteristics</b>										
Termination type		solder								
Interlock		push-pull								
<b>Air and Fluid Transmission</b>										
Maximum working pressure		2 bar								
Mechanical operation		> 1.000 mating cycles								
Inner fluid contact diameter		2.6 mm								
Tube diameter inner Ø / outer Ø		4 mm / 6 mm								

1) Values for all cavities populated. For partial population higher values may be possible depending on application. 2) Higher values on request 3) Risk of injury at higher temperatures

Plastic Characteristics	Standard	Unit	PSU	PEI	PEEK
Flammability	UL 94		VO/4.5	VO/0.41	VO/0.75
Operating temperature		°C	- 50°C ... + 170°C	- 50°C ... + 170°C	- 50°C ... + 240°C
Sterilization (autoclave)	DIN EN 13060	number	~20	>100	>200



The stated technical values refer to the use as connector without breaking capacity (COC). If these components are used as plug and socket device a reduced current carrying capacity has to be considered. The characteristics have to be requested from the manufacturer.

Part Number Configuration

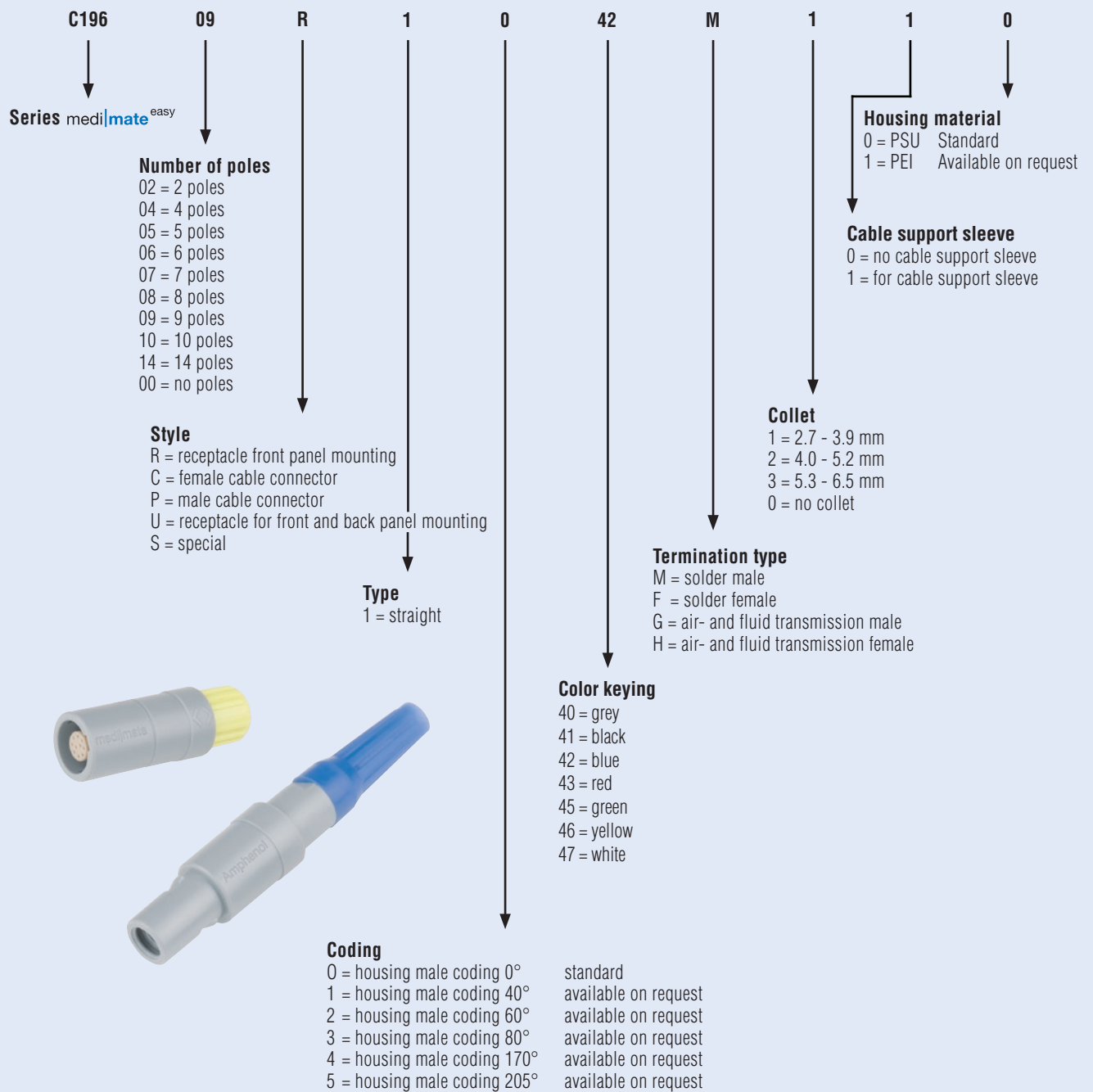

Angle	0°	40°	60°	80°	170°	205°	
Male Cable Connector							Other codings on request
Codings	Standard	Available on request					

Male cable connector, straight  
no cable support sleeve, coding 0°  
Mateable with female receptacle and cable connector

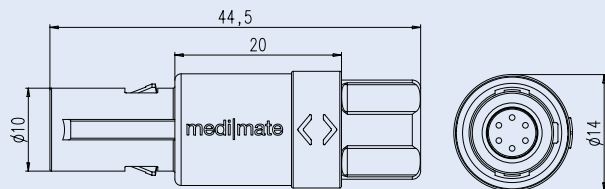

Color	Part number Collet 2.7 - 3.9 mm	Part number Collet 4.0 - 5.2 mm	Part number Collet 5.3 - 6.5 mm
grey	C196 <u>XX</u> P1040 M100	C196 <u>XX</u> P1040 M200	C196 <u>XX</u> P1040 M300
black	C196 <u>XX</u> P1041 M100	C196 <u>XX</u> P1041 M200	C196 <u>XX</u> P1041 M300
blue	C196 <u>XX</u> P1042 M100	C196 <u>XX</u> P1042 M200	C196 <u>XX</u> P1042 M300
red	C196 <u>XX</u> P1043 M100	C196 <u>XX</u> P1043 M200	C196 <u>XX</u> P1043 M300
green	C196 <u>XX</u> P1045 M100	C196 <u>XX</u> P1045 M200	C196 <u>XX</u> P1045 M300
yellow	C196 <u>XX</u> P1046 M100	C196 <u>XX</u> P1046 M200	C196 <u>XX</u> P1046 M300
white	C196 <u>XX</u> P1047 M100	C196 <u>XX</u> P1047 M200	C196 <u>XX</u> P1047 M300

**XX = Selection number of poles**

02 = 2 male contacts	08 = 8 male contacts
04 = 4 male contacts	09 = 9 male contacts
05 = 5 male contacts	10 = 10 male contacts
06 = 6 male contacts	14 = 14 male contacts
07 = 7 male contacts	

Male cable connector, straight  
with cable support sleeve, coding 0°  
Please order cable support sleeve separately  
Mateable with female receptacle and cable connector

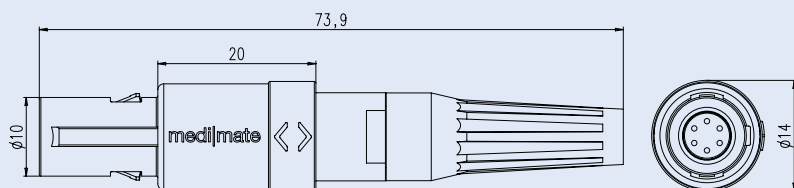

Color	Part number Cable Ø 2.5 - 3.0 mm	Part number Cable Ø 3.0 - 3.5 mm	Part number Cable Ø 3.5 - 4.0 mm
<b>Connector without cable support sleeve</b>			
grey	C196 <u>XX</u> P1040 M110	C196 <u>XX</u> P1040 M110	C196 <u>XX</u> P1040 M210
<b>Matching cable support sleeves</b>			
grey	C196 Z T1040	C196 Z T2040	C196 Z T3040
black	C196 Z T1041	C196 Z T2041	C196 Z T3041
blue	C196 Z T1042	C196 Z T2042	C196 Z T3042
red	C196 Z T1043	C196 Z T2043	C196 Z T3043
green	C196 Z T1045	C196 Z T2045	C196 Z T3045
yellow	C196 Z T1046	C196 Z T2046	C196 Z T3046
white	C196 Z T1047	C196 Z T2047	C196 Z T3047

**XX = Selection number of poles**

02 = 2 male contacts	08 = 8 male contacts
04 = 4 male contacts	09 = 9 male contacts
05 = 5 male contacts	10 = 10 male contacts
06 = 6 male contacts	14 = 14 male contacts
07 = 7 male contacts	

Color	Part number Cable Ø 4.0 - 5.0 mm	Part number Cable Ø 5.0 - 6.0 mm	Part number Cable Ø 6.0 - 6.5 mm
<b>Connector without cable support sleeve</b>			
grey	C196 <u>XX</u> P1040 M210	C196 <u>XX</u> P1040 M310	C196 <u>XX</u> P1040 M310
<b>Matching cable support sleeves</b>			
grey	C196 Z T4040	C196 Z T5040	C196 Z T6040
black	C196 Z T4041	C196 Z T5041	C196 Z T6041
blue	C196 Z T4042	C196 Z T5042	C196 Z T6042
red	C196 Z T4043	C196 Z T5043	C196 Z T6043
green	C196 Z T4045	C196 Z T5045	C196 Z T6045
yellow	C196 Z T4046	C196 Z T5046	C196 Z T6046
white	C196 Z T4047	C196 Z T5047	C196 Z T6047

**XX = Selection number of poles**

02 = 2 male contacts	08 = 8 male contacts
04 = 4 male contacts	09 = 9 male contacts
05 = 5 male contacts	10 = 10 male contacts
06 = 6 male contacts	14 = 14 male contacts
07 = 7 male contacts	

Female cable connector, straight  
no cable support sleeves, coding 0°  
Mateable with male cable connector

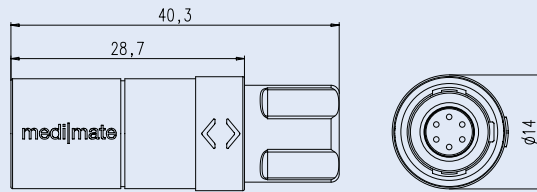

Color	Part number Collet Ø 2.7 - 3.9 mm	Part number Collet Ø 4.0 - 5.2 mm	Part number Collet Ø 5.3 - 6.5 mm	XX = Selection number of contacts	
grey	C196 <u>XXC</u> 1040 F100	C196 <u>XXC</u> 1040 F200	C196 <u>XXC</u> 1040 F300	02 = 2 female contacts	08 = 8 female contacts
black	C196 <u>XXC</u> 1041 F100	C196 <u>XXC</u> 1041 F200	C196 <u>XXC</u> 1041 F300	04 = 4 female contacts	09 = 9 female contacts
blue	C196 <u>XXC</u> 1042 F100	C196 <u>XXC</u> 1042 F200	C196 <u>XXC</u> 1042 F300	05 = 5 female contacts	10 = 10 female contacts
red	C196 <u>XXC</u> 1043 F100	C196 <u>XXC</u> 1043 F200	C196 <u>XXC</u> 1043 F300	06 = 6 female contacts	14 = 14 female contacts
green	C196 <u>XXC</u> 1045 F100	C196 <u>XXC</u> 1045 F200	C196 <u>XXC</u> 1045 F300	07 = 7 female contacts	
yellow	C196 <u>XXC</u> 1046 F100	C196 <u>XXC</u> 1046 F200	C196 <u>XXC</u> 1046 F300		
white	C196 <u>XXC</u> 1047 F100	C196 <u>XXC</u> 1047 F200	C196 <u>XXC</u> 1047 F300		

Female cable connector, straight  
with cable support sleeves, coding 0°  
Please order cable support sleeves separately  
Mateable with male cable connector

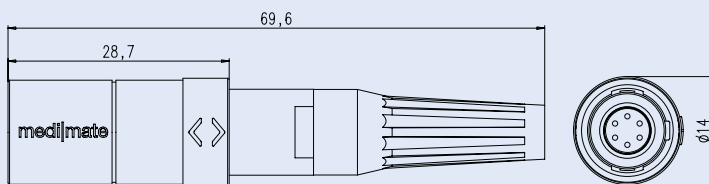

Color	Part number Cable Ø 2.5 - 3.0 mm	Part number Cable Ø 3.0 - 3.5 mm	Part number Cable Ø 3.5 - 4.0 mm	XX = Selection number of contacts	
<b>Connector without cable support sleeve</b>				02 = 2 female contacts	08 = 8 female contacts
grey	C196 <u>XXC</u> 1040 F110	C196 <u>XXC</u> 1040 F110	C196 <u>XXC</u> 1040 F210	04 = 4 female contacts	09 = 9 female contacts
<b>Matching cable support sleeves</b>				05 = 5 female contacts	10 = 10 female contacts
grey	C196 Z T1040	C196 Z T2040	C196 Z T3040	06 = 6 female contacts	14 = 14 female contacts
black	C196 Z T1041	C196 Z T2041	C196 Z T3041	07 = 7 female contacts	
blue	C196 Z T1042	C196 Z T2042	C196 Z T3042		
red	C196 Z T1043	C196 Z T2043	C196 Z T3043		
green	C196 Z T1045	C196 Z T2045	C196 Z T3045		
yellow	C196 Z T1046	C196 Z T2046	C196 Z T3046		
white	C196 Z T1047	C196 Z T2047	C196 Z T3047		

Color	Part number Cable Ø 4.0 - 5.0 mm	Part number Cable Ø 5.0 - 6.0 mm	Part number Cable Ø 6.0 - 6.5 mm	XX = Selection number of contacts	
<b>Connector without cable support sleeve</b>				02 = 2 female contacts	08 = 8 female contacts
grey	C196 <u>XXC</u> 1040 F210	C196 <u>XXC</u> 1040 F310	C196 <u>XXC</u> 1040 F310	04 = 4 female contacts	09 = 9 female contacts
<b>Matching cable support sleeves</b>				05 = 5 female contacts	10 = 10 female contacts
grey	C196 Z T4040	C196 Z T5040	C196 Z T6040	06 = 6 female contacts	14 = 14 female contacts
black	C196 Z T4041	C196 Z T5041	C196 Z T6041	07 = 7 female contacts	
blue	C196 Z T4042	C196 Z T5042	C196 Z T6042		
red	C196 Z T4043	C196 Z T5043	C196 Z T6043		
green	C196 Z T4045	C196 Z T5045	C196 Z T6045		
yellow	C196 Z T4046	C196 Z T5046	C196 Z T6046		
white	C196 Z T4047	C196 Z T5047	C196 Z T6047		



Male cable connector, straight for air and fluid transmission,  
 working pressure up to 2 bar  
 no cable support sleeve, coding 0°  
 Mateable with female receptacle and cable connector  
 Available on request

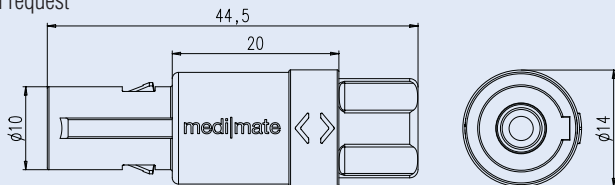

Color	Part number Collet Ø 2.7 - 3.9 mm	Part number Collet Ø 4.0 - 5.2 mm	Part number Collet Ø 5.3 - 6.5 mm
grey	C196 00P1040 G100	C196 00P1040 G200	C196 00P1040 G300
black	C196 00P1041 G100	C196 00P1041 G200	C196 00P1041 G300
blue	C196 00P1042 G100	C196 00P1042 G200	C196 00P1042 G300
red	C196 00P1043 G100	C196 00P1043 G200	C196 00P1043 G300
green	C196 00P1045 G100	C196 00P1045 G200	C196 00P1045 G300
yellow	C196 00P1046 G100	C196 00P1046 G200	C196 00P1046 G300
white	C196 00P1047 G100	C196 00P1047 G200	C196 00P1047 G300

Male cable connector, straight for air and fluid transmission,  
 working pressure up to 2 bar, with cable support sleeve, coding 0°  
 Please order cable support sleeves separately  
 Mateable with female receptacle and cable connector  
 Available on request

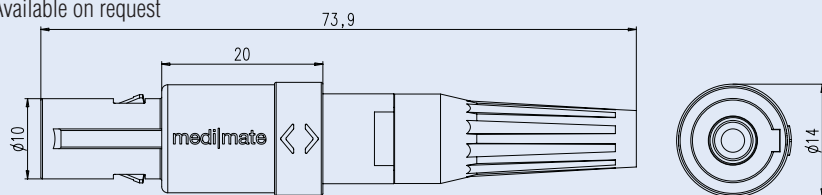

Color	Part number Cable Ø 2.5 - 3.0 mm	Part number Cable Ø 3.0 - 3.5 mm	Part number Cable Ø 3.5 - 4.0 mm
<b>Connector without cable support sleeve</b>			
grey	C196 00P1040 G110	C196 00P1040 G110	C196 00P1040 G210
<b>Matching cable support sleeve</b>			
grey	C196 Z T1040	C196 Z T2040	C196 Z T3040
black	C196 Z T1041	C196 Z T2041	C196 Z T3041
blue	C196 Z T1042	C196 Z T2042	C196 Z T3042
red	C196 Z T1043	C196 Z T2043	C196 Z T3043
green	C196 Z T1045	C196 Z T2045	C196 Z T3045
yellow	C196 Z T1046	C196 Z T2046	C196 Z T3046
white	C196 Z T1047	C196 Z T2047	C196 Z T3047

Color	Part number Cable Ø 4.0 - 5.0 mm	Part number Cable Ø 5.0 - 6.0 mm	Part number Cable Ø 6.0 - 6.5 mm
<b>Connector without cable support sleeve</b>			
grey	C196 00P1040 G210	C196 00P1040 G310	C196 00P1040 G310
<b>Matching cable support sleeve</b>			
grey	C196 Z T4040	C196 Z T5040	C196 Z T6040
black	C196 Z T4041	C196 Z T5041	C196 Z T6041
blue	C196 Z T4042	C196 Z T5042	C196 Z T6042
red	C196 Z T4043	C196 Z T5043	C196 Z T6043
green	C196 Z T4045	C196 Z T5045	C196 Z T6045
yellow	C196 Z T4046	C196 Z T5046	C196 Z T6046
white	C196 Z T4047	C196 Z T5047	C196 Z T6047

Female cable connector, straight for air and fluid transmission,  
 working pressure up to 2 bar  
 no cable support sleeve, coding 0°  
 Mateable with male cable connector  
 Available on request

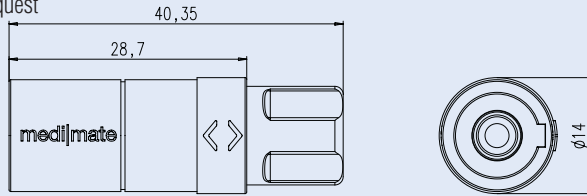

Color	Part number Collet Ø 2.7 - 3.9 mm	Part number Collet Ø 4.0 - 5.2 mm	Part number Collet Ø 5.3 - 6.5 mm
grey	C196 00C1040 H100	C196 00C1040 H200	C196 00C1040 H300
black	C196 00C1041 H100	C196 00C1041 H200	C196 00C1041 H300
blue	C196 00C1042 H100	C196 00C1042 H200	C196 00C1042 H300
red	C196 00C1043 H100	C196 00C1043 H200	C196 00C1043 H300
green	C196 00C1045 H100	C196 00C1045 H200	C196 00C1045 H300
yellow	C196 00C1046 H100	C196 00C1046 H200	C196 00C1046 H300
white	C196 00C1047 H100	C196 00C1047 H200	C196 00C1047 H300

Female cable connector, straight for air and fluid transmission,  
 working pressure up to 2 bar, with cable support sleeve, coding 0°  
 Please order cable support sleeves separately  
 Mateable with male cable connector  
 Available on request

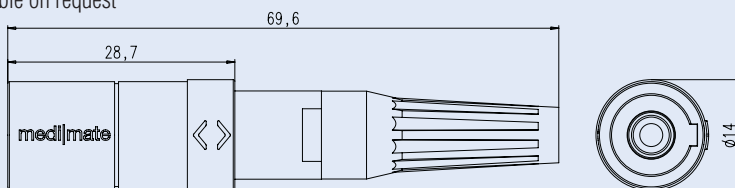

Color	Part number Cable Ø 2.5 - 3.0 mm	Part number Cable Ø 3.0 - 3.5 mm	Part number Cable Ø 3.5 - 4.0 mm
<b>Connector without cable support sleeve</b>			
grey	C196 00C1040 H110	C196 00C1040 H110	C196 00C1040 H210
<b>Matching cable support sleeve</b>			
grey	C196 Z T1040	C196 Z T2040	C196 Z T3040
black	C196 Z T1041	C196 Z T2041	C196 Z T3041
blue	C196 Z T1042	C196 Z T2042	C196 Z T3042
red	C196 Z T1043	C196 Z T2043	C196 Z T3043
green	C196 Z T1045	C196 Z T2045	C196 Z T3045
yellow	C196 Z T1046	C196 Z T2046	C196 Z T3046
white	C196 Z T1047	C196 Z T2047	C196 Z T3047

Color	Part number Cable Ø 4.0 - 5.0 mm	Part number Cable Ø 5.0 - 6.0 mm	Part number Cable Ø 6.0 - 6.5 mm
<b>Connector without cable support sleeve</b>			
grey	C196 00C1040 H210	C196 00C1040 H310	C196 00C1040 H310
<b>Matching cable support sleeve</b>			
grey	C196 Z T4040	C196 Z T5040	C196 Z T6040
black	C196 Z T4041	C196 Z T5041	C196 Z T6041
blue	C196 Z T4042	C196 Z T5042	C196 Z T6042
red	C196 Z T4043	C196 Z T5043	C196 Z T6043
green	C196 Z T4045	C196 Z T5045	C196 Z T6045
yellow	C196 Z T4046	C196 Z T5046	C196 Z T6046
white	C196 Z T4047	C196 Z T5047	C196 Z T6047

Female receptacle  
for front panel mounting, coding 0°  
for front and rear panel mounting, coding 0°  
Mateable with male cable connector

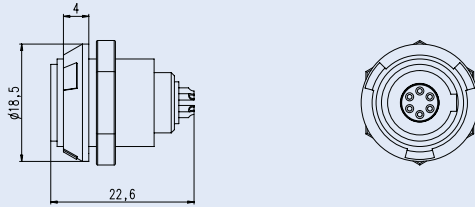

Color	Part number For front panel mounting	Part number / For front and rear panel mounting	Panel hole
grey	C196 XXR1040 F000	C196 XXU1040 F000	<p>Nut of receptacles: 1.5 Nm</p>
black	C196 XXR1041 F000	C196 XXU1041 F000	
blue	C196 XXR1042 F000	C196 XXU1042 F000	
red	C196 XXR1043 F000	C196 XXU1043 F000	
green	C196 XXR1045 F000	C196 XXU1045 F000	
yellow	C196 XXR1046 F000	C196 XXU1046 F000	
white	C196 XXR1047 F000	C196 XXU1047 F000	

**XX = Selection number of poles**

02 = 2 female contacts	08 = 8 female contacts
04 = 4 female contacts	09 = 9 female contacts
05 = 5 female contacts	10 = 10 female contacts
06 = 6 female contacts	14 = 14 female contacts
07 = 7 female contacts	

Female receptacle  
for air and fluid transmission, working pressure up to 2 bar  
for front panel mounting, coding 0°  
for front and rear panel mounting, coding 0°  
Mateable with male cable connector  
Available on request

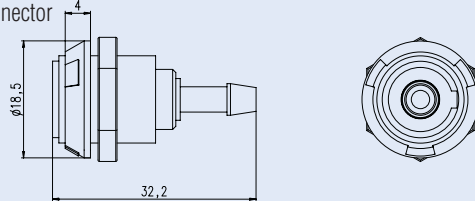

Color	Part number For front panel mounting	Part number / For front and rear panel mounting	Panel hole
grey	C196 00R1040 H000	C196 00U1040 H000	<p>Nut of receptacles: 1.5 Nm</p>
black	C196 00R1041 H000	C196 00U1041 H000	
blue	C196 00R1042 H000	C196 00U1042 H000	
red	C196 00R1043 H000	C196 00U1043 H000	
green	C196 00R1045 H000	C196 00U1045 H000	
yellow	C196 00R1046 H000	C196 00U1046 H000	
white	C196 00R1047 H000	C196 00U1047 H000	

Mounting Instruction For Male and Female Cable Connectors

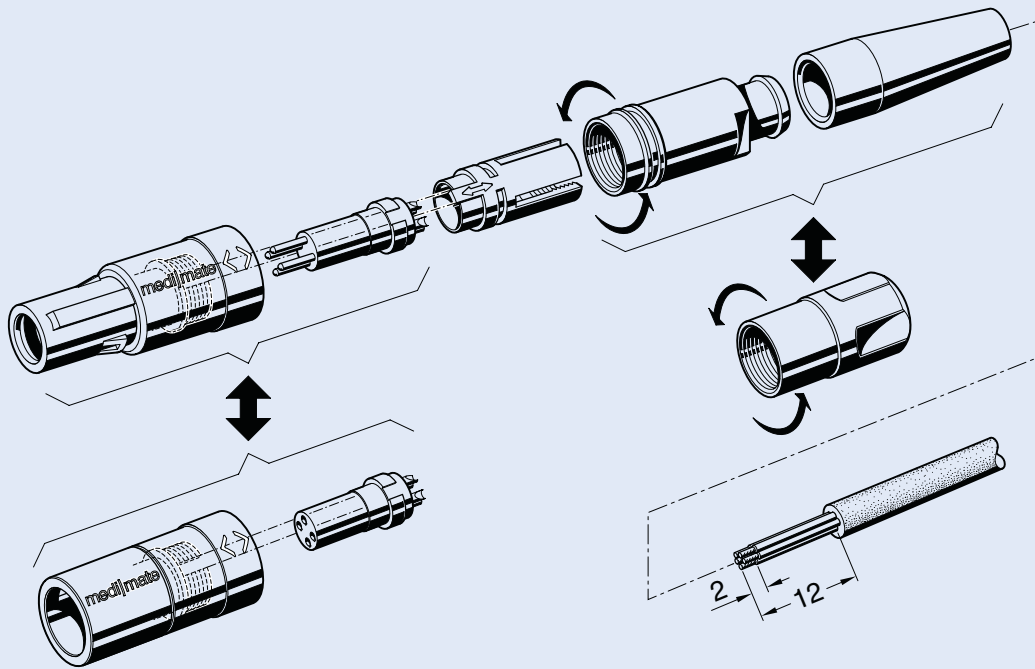

Derating Curves

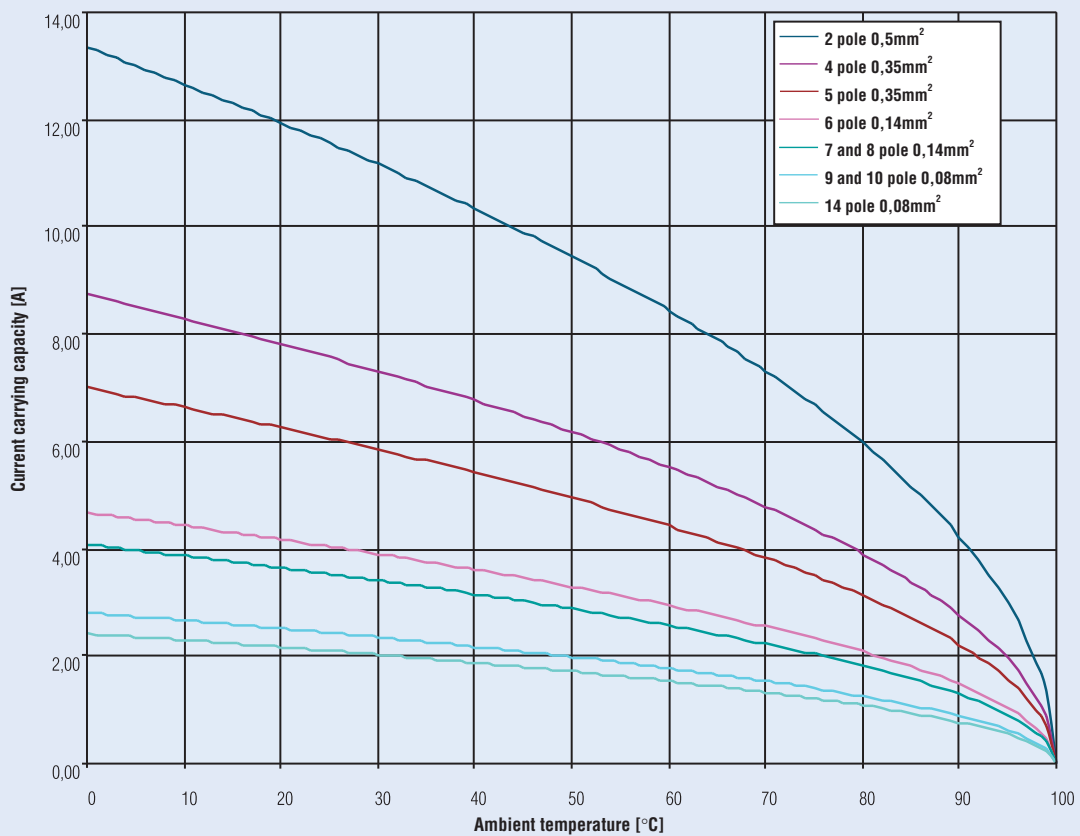

**Degree of Protection**

Electrical devices to which connectors belong to have to be protected for safety reasons from outside influences like dust, foreign objects, direct contact, moisture and water. This protection is provided on connectors by its housings with their latching devices and sealed cable entries. The degree of protection can be selected depending on the type of intended use. The standard IEC 60529 and/or DIN EN 60529/VDE 0470 Part 1 has specified the degree of protection and divided into several classes.

The degree of protection is indicated in the following way:

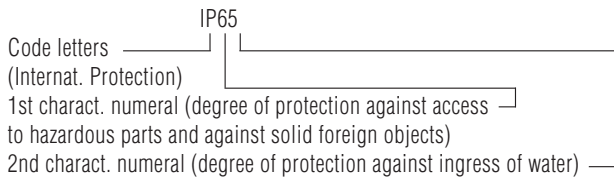

The following chart gives an overview about all protection degrees.

1st charact. numeral	Brief description	Definition
0	Non-protected	–
1	Protected against access to hazardous parts with the back of a hand. Protected against solid foreign objects of $\geq 50\text{mm } \varnothing$ .	The probe, sphere of $50\text{mm } \varnothing$ , shall not fully penetrate and shall have adequate clearance from hazardous parts.
2	Protected against access to hazardous parts with a finger. Protected against solid foreign objects of $\geq 12,5\text{mm } \varnothing$ .	The jointed test finger of $12\text{mm } \varnothing$ , $80\text{mm}$ length, shall have adequate clearance from hazardous parts. The probe, sphere of $12,5\text{mm } \varnothing$ , shall not fully penetrate.
3	Protected against access to hazardous parts with a tool. Protected against solid foreign objects of $\geq 2,5\text{mm } \varnothing$ .	The probe of $2,5\text{mm } \varnothing$ shall not penetrate at all.
4	Protected against access to hazardous parts with a wire. Protected against solid foreign objects of $\geq 1\text{mm } \varnothing$ .	The probe of $1\text{mm } \varnothing$ shall not penetrate at all.
5	Protected against access to hazardous parts with a wire. Dust-protected.	The probe of $1\text{mm } \varnothing$ shall not penetrate. Intrusion of dust is not totally prevented, but dust shall not penetrate in a quantity to interfere with satisfactory operation of the device or to impair safety.
6	Protected against access to hazardous parts with a wire. Dust-tight.	The probe of $1\text{mm } \varnothing$ shall not penetrate. No intrusion of dust.

2nd charact. numeral	Brief description	Definition
0	Non-protected	–
1	Protected against vertically falling water drops	Vertically falling drops shall have no harmful effects.
2	Protected against vertically falling water drops when enclosure tilted up to $15^\circ$	Vertically falling drops shall have no harmful effects when the enclosure is tilted at any angle up to $15^\circ$ on either side of the vertical.
3	Protected against spraying water	Water sprayed at an angle up to $60^\circ$ on either side of the vertical shall have no harmful effects.
4	Protected against splashing water	Water splashed against the enclosure from any direction shall have no harmful effects.
5	Protected against water jets	Water projected in jets against the enclosure from any direction shall have no harmful effects.
6	Protected against powerful water jets	Water projected in powerful jets against the enclosure from any direction shall have no harmful effects.
7	Protected against the effects of temporary immersion in water	Intrusion of water in quantities causing harmful effects shall not be possible when the enclosure is temporarily immersed in water for 30 min. in $1\text{m}$ depth.
8	Protected against the effects of continuous immersion in water	Intrusion of water in quantities causing harmful effects shall not be possible when the enclosure is continuously immersed in water under conditions which shall be agreed between manufacturer and user but which are more severe than for numeral 7.
9K <sup>1)</sup>	Protected against water during high pressure/steam jet cleaning	Water projected in powerful jets with high pressure against the enclosure from any direction shall have no harmful effects.

<sup>1)</sup> Remark: Numeral acc. to DIN 40050 part 9, vehicles IP code.

Cross reference between American Wire Gauge (AWG) and metric wire sizes (mm<sup>2</sup>)

AWG	Wire composition	Wire diameter	Wire size
30	1 x 0.25	0.25 mm	0.05 mm <sup>2</sup>
	7 x 0.10	0.36 mm	0.06 mm <sup>2</sup>
28	1 x 0.32	0.32 mm	0.08 mm <sup>2</sup>
	7 x 0.13	0.38 mm	0.09 mm <sup>2</sup>
26	1 x 0.40	0.40 mm	0.13 mm <sup>2</sup>
	7 x 0.16	0.48 mm	0.14 mm <sup>2</sup>
	19 x 0.10	0.51 mm	0.15 mm <sup>2</sup>
24	1 x 0.51	0.51 mm	0.21 mm <sup>2</sup>
	7 x 0.20	0.61 mm	0.23 mm <sup>2</sup>
	19 x 0.13	0.64 mm	0.24 mm <sup>2</sup>
22	1 x 0.64	0.64 mm	0.33 mm <sup>2</sup>
	7 x 0.25	0.76 mm	0.36 mm <sup>2</sup>
	19 x 0.16	0.81 mm	0.38 mm <sup>2</sup>

AWG	Wire composition	Wire diameter	Wire size
20	1 x 0.81	0.81 mm	0.52 mm <sup>2</sup>
	7 x 0.32	0.97 mm	0.56 mm <sup>2</sup>
	19 x 0.20	1.02 mm	0.62 mm <sup>2</sup>
18	1 x 1.02	1.02 mm	0.79 mm <sup>2</sup>
	19 x 0.25	1.27 mm	0.96 mm <sup>2</sup>
16	19 x 0.29	1.44 mm	1.23 mm <sup>2</sup>
14	19 x 0.36	1.80 mm	1.95 mm <sup>2</sup>
12	19 x 0.46	2.29 mm	3.09 mm <sup>2</sup>
10	37 x 0.40	3.10 mm	4.60 mm <sup>2</sup>
8	133 x 0.29	4.0 mm	8.80 mm <sup>2</sup>
6	133 x 0.36	5.5 mm	13.5 mm <sup>2</sup>

Please note that wires of the same AWG number but with different composition have slightly different mm<sup>2</sup>.

Remarks / Safety Classification 

**1. General Remarks**

These connectors are designed and produced in conformity with the directives IEC 60068-1 (VDE 0110-1), IEC 60512-2, IEC60512-5-1 and IEC 60512-9-1.

The connectors may be used only within the technical ratings.

All technical data refer to mated connectors under live conditions.

The safety of the connector system depends on the correct selection of products, proper assembly of the connector device and a precise fit of the connectors.

**2. Application Remarks**

Connectors with / without breaking capacity must be used according to specified technical ratings.

The technical data represents the initial value of mated parts under predetermined conditions and length of time. These values could change with different test parameters or product requirements.

The product has been tested for the intended purposes only. If the connection is used other than originally intended, or in another manner that we have not previously tested, the consumer assumes full responsibility.

All rated data for the connectors listed in this catalogue are based on over-voltage category III<sup>1)</sup> and pollution degree I for electronic applications. Connectors were completely mated according to their respective safety locking mechanism. Selection and testing of connectors with / without breaking capacity to meet specific product or industrial requirements such as rated voltage and the related clearances and creepage distances are the responsibility of the user.

**3. Assembling Remarks**

Protection against electrical shock of the termination of the connectors shall be secured by correct mounting. Connectors of the same or different series being mounted side by side may be protected against incorrect mating by the use of coding options. Care must be taken to ensure the parts are correctly mated and nuts are tightened with the proper torque.

**4. Termination Remarks**

Cable connectors are effectively secured when using the strain relief (internal strain relief). All cable properties or specifications must be compatible with the connector design and materials.

Designated wire conductors must be terminated to the correct poles in the connector.

Wire should be stripped correctly according to printed specifications to insure no electrical contact can be made between the conductors. There should be no nicked or cut strains during the stripping action.

<sup>1)</sup> Overvoltage category III: Equipment intended for the use in installations or parts of it in which lightning overvoltages do not need to be considered, however switching overvoltages generated by the equipment, and for cases where the reliability and the availability of the equipment or its dependent circuits are subject to special requirements. Examples are protecting means, switches and sockets.

Part No.	Page	Part No.	Page	Part No.	Page	Part No.	Page
C196 00C1040 H100	10	C196 00P1047 G200	9	C196 XXP1041 M100	7	C196 Z T3040	7, 8, 9, 10
C196 00C1040 H110	10	C196 00P1047 G300	9	C196 XXP1041 M200	7	C196 Z T3041	7, 8, 9, 10
C196 00C1040 H200	10	C196 00R1040 H000	11	C196 XXP1041 M300	7	C196 Z T3042	7, 8, 9, 10
C196 00C1040 H210	10	C196 00R1041 H000	11	C196 XXP1042 M100	7	C196 Z T3043	7, 8, 9, 10
C196 00C1040 H300	10	C196 00R1042 H000	11	C196 XXP1042 M200	7	C196 Z T3045	7, 8, 9, 10
C196 00C1040 H310	10	C196 00R1043 H000	11	C196 XXP1042 M300	7	C196 Z T3046	7, 8, 9, 10
C196 00C1041 H100	10	C196 00R1045 H000	11	C196 XXP1043 M100	7	C196 Z T3047	7, 8, 9, 10
C196 00C1041 H200	10	C196 00R1046 H000	11	C196 XXP1043 M200	7	C196 Z T4040	7, 8, 9, 10
C196 00C1041 H300	10	C196 00R1047 H000	11	C196 XXP1043 M300	7	C196 Z T4041	7, 8, 9, 10
C196 00C1042 H100	10	C196 00U1040 H000	11	C196 XXP1045 M100	7	C196 Z T4042	7, 8, 9, 10
C196 00C1042 H200	10	C196 00U1041 H000	11	C196 XXP1045 M200	7	C196 Z T4043	7, 8, 9, 10
C196 00C1042 H300	10	C196 00U1042 H000	11	C196 XXP1045 M300	7	C196 Z T4045	7, 8, 9, 10
C196 00C1043 H100	10	C196 00U1043 H000	11	C196 XXP1046 M100	7	C196 Z T4046	7, 8, 9, 10
C196 00C1043 H200	10	C196 00U1045 H000	11	C196 XXP1046 M200	7	C196 Z T4047	7, 8, 9, 10
C196 00C1043 H300	10	C196 00U1046 H000	11	C196 XXP1046 M300	7	C196 Z T5040	7, 8, 9, 10
C196 00C1045 H100	10	C196 00U1047 H000	11	C196 XXP1047 M100	7	C196 Z T5041	7, 8, 9, 10
C196 00C1045 H200	10	C196 XXC1040 F100	8	C196 XXP1047 M200	7	C196 Z T5042	7, 8, 9, 10
C196 00C1045 H300	10	C196 XXC1040 F110	8	C196 XXP1047 M300	7	C196 Z T5043	7, 8, 9, 10
C196 00C1046 H100	10	C196 XXC1040 F200	8	C196 XXR1040 F000	11	C196 Z T5045	7, 8, 9, 10
C196 00C1046 H200	10	C196 XXC1040 F210	8	C196 XXR1041 F000	11	C196 Z T5046	7, 8, 9, 10
C196 00C1046 H300	10	C196 XXC1040 F300	8	C196 XXR1042 F000	11	C196 Z T5047	7, 8, 9, 10
C196 00C1047 H100	10	C196 XXC1040 F310	8	C196 XXR1043 F000	11	C196 Z T6040	7, 8, 9, 10
C196 00C1047 H200	10	C196 XXC1041 F100	8	C196 XXR1045 F000	11	C196 Z T6041	7, 8, 9, 10
C196 00C1047 H300	10	C196 XXC1041 F200	8	C196 XXR1046 F000	11	C196 Z T6042	7, 8, 9, 10
C196 00P1040 G100	9	C196 XXC1041 F300	8	C196 XXR1047 F000	11	C196 Z T6043	7, 8, 9, 10
C196 00P1040 G110	9	C196 XXC1042 F100	8	C196 XXU1040 F000	11	C196 Z T6045	7, 8, 9, 10
C196 00P1040 G200	9	C196 XXC1042 F200	8	C196 XXU1041 F000	11	C196 Z T6046	7, 8, 9, 10
C196 00P1040 G210	9	C196 XXC1042 F300	8	C196 XXU1042 F000	11	C196 Z T6047	7, 8, 9, 10
C196 00P1040 G300	9	C196 XXC1043 F100	8	C196 XXU1043 F000	11		
C196 00P1040 G310	9	C196 XXC1043 F200	8	C196 XXU1045 F000	11		
C196 00P1041 G100	9	C196 XXC1043 F300	8	C196 XXU1046 F000	11		
C196 00P1041 G200	9	C196 XXC1045 F100	8	C196 XXU1047 F000	11		
C196 00P1041 G300	9	C196 XXC1045 F200	8	C196 Z T1040	7, 8, 9, 10		
C196 00P1042 G100	9	C196 XXC1045 F300	8	C196 Z T1041	7, 8, 9, 10		
C196 00P1042 G200	9	C196 XXC1046 F100	8	C196 Z T1042	7, 8, 9, 10		
C196 00P1042 G300	9	C196 XXC1046 F200	8	C196 Z T1043	7, 8, 9, 10		
C196 00P1043 G100	9	C196 XXC1046 F300	8	C196 Z T1045	7, 8, 9, 10		
C196 00P1043 G200	9	C196 XXC1047 F100	8	C196 Z T1046	7, 8, 9, 10		
C196 00P1043 G300	9	C196 XXC1047 F200	8	C196 Z T1047	7, 8, 9, 10		
C196 00P1045 G100	9	C196 XXC1047 F300	8	C196 Z T2040	7, 8, 9, 10		
C196 00P1045 G200	9	C196 XXP1040 M100	7	C196 Z T2041	7, 8, 9, 10		
C196 00P1045 G300	9	C196 XXP1040 M110	7	C196 Z T2042	7, 8, 9, 10		
C196 00P1046 G100	9	C196 XXP1040 M200	7	C196 Z T2043	7, 8, 9, 10		
C196 00P1046 G200	9	C196 XXP1040 M210	7	C196 Z T2045	7, 8, 9, 10		
C196 00P1046 G300	9	C196 XXP1040 M300	7	C196 Z T2046	7, 8, 9, 10		
C196 00P1047 G100	9	C196 XXP1040 M310	7	C196 Z T2047	7, 8, 9, 10		

## International

### Argentina

Amphenol Argentina  
Av. Callao 930  
2nd Floor Office B "Plaza"  
C 1023 AAP Buenos Aires  
Phone +54 / 11 / 48156886  
Fax +54 / 11 / 48145779

### Australia

Amphenol Australia Ltd.  
2 Fiveways Blvd  
Keysborough  
Victoria 3173  
Phone +61 / 3 / 8796 / 8888  
Fax +61 / 3 / 8796 / 8801

### Belgium

Amphenol-Tuchel Belgium  
Brusselbaan 524b  
B 1600 Sint-Pieters-Leeuw  
Phone +32 / 2377 / 2549  
Fax +32 / 2377 / 5303

### Brasilia

Amphenol do Brasil Ltda.  
Rua Diogo Moreira 132, 20th Floor  
CEP 05423-010 Sao Paulo SP  
Phone +55 / 11 / 3815.1003  
Fax +55 / 11 / 3815.1629

### China

Amphenol-Tuchel Electronics GmbH  
China Branch  
210-1 Taishan Road  
Changzhou 213022  
Phone +86 / 0519 / 5110301  
Fax +86 / 0519 / 5110299

### France

Amphenol-Tuchel France  
Bât. Le Newton C  
7 Mail B. Thimonnier  
77185 Lognes  
Phone +33 / 164627676  
Fax +33 / 164627677

### Germany

Amphenol-Tuchel Electronics GmbH  
August-Haessler-Str. 10  
74080 Heilbronn  
Phone +49 / 7131 / 929-0  
Fax +49 / 7131 / 929-486

### Great Britain

Amphenol-Tuchel Great Britain  
PO Box 6766  
Basingstoke  
RG24 4JG  
Phone +44 / 1256 / 330749  
Fax +44 / 1256 / 330749

### Hong Kong

Amphenol East Asia Limited  
Units 2201-02, Railway Plaza  
39 Chatham Road South  
Tsimshatsui, Kowloon  
Phone +852 / 2699 / 2663  
Fax +852 / 2688 / 0974

### India

Amphetrnix Limited  
Plot No. 105 Bhosari Industrial Area  
Pune - 411 026  
Phone +91 / 20 / 27121418  
Fax +91 / 20 / 27120581

### Italy

Amphenol-Tuchel Italy  
Via Barbaiana n. 5  
I-20020 Lainate (MI)  
Phone +39 / 2 / 932 541  
Fax +39 / 2 / 932 54444

### Japan

Amphenol Japan, K.K.  
2-3-27, Kudan Minami  
Chiyoda-Ku  
Tokyo 102  
Phone +81 / 3 / 3263 / 5611  
Fax +81 / 3 / 5276 / 7059

### Korea

Amphenol DaeShin Limited  
558 Songnae-Dong, Sosa-Gu  
Bucheon-City, Kyunggi-Do  
Korea 422-040  
Phone +82 / 2 / 785 / 1588  
Fax +82 / 2 / 589 / 1514

### Mexico

Amphenol Mexico  
Prolongacion Reforma 61 - 6 B2  
Col. Paseo de las Lomas  
C.P. 01330 Mexico D.F.  
Phone +52 / 55 / 5258.9984  
Fax +52 / 55 / 5081.6890

### Singapore

Amphenol East Asia Limited  
Asia Pacific Sales Operation  
Singapore Branch  
300 Beach Road  
#25-07 The Concourse  
Singapore 199555  
Phone +27 / 11 / 305-9574  
Fax +27 / 11 / 305-9576

### South Africa

Amphenol International Ltd  
Chislehurst  
30 Impala Road  
Chislehurst  
Sandton, 2146  
Phone +27 / 11 / 7839517  
Fax +27 / 11 / 7839519

### Spain

Amphenol-Tuchel Spain  
Ctra Sabadell a Mollet,  
km 4.5 Nave 5  
08130 Santa Perpetua de  
Mogoda (Barcelona)  
Phone +34 / 93 / 574.41.34  
Fax +34 / 93 / 574.10.09

### Sweden

Amphenol-Tuchel Scandinavia  
P.O. Box 20  
SE 195 42 Märsta  
Phone +46 / 8 591 / 175 76  
Fax +46 / 8 591 / 175 76

### Taiwan

Amphenol East Asia Ltd.  
Taiwan Branch (H.K.)  
116 Zhong Shan Road  
Lane 956 Taoyuan City  
Taiwan R.O.C. 330  
Phone +886 / 3 / 370 / 7855  
Fax +886 / 3 / 360 / 7259

### Turkey

Amphenol Türkiye  
Ayazaga Mah. Meydan Sk. No. 28  
Beybi Giz Plaza, Kat. 26  
34396 Maslak/Istanbul  
Phone +90 / 0212 / 3352501  
Fax +90 / 0212 / 3352500

### USA

Amphenol-Tuchel Electronics  
6900 Haggerty Road  
Suite 200  
Canton, Michigan 48187  
Phone +1 / 734 / 4516400  
Fax +1 / 734 / 451 7197

Amphenol Corporation  
Corporate Headquarters  
358 Hall Avenue  
Wallingford, CT 06492  
Phone +1 / 800 / 380 8052  
Phone +1 / 203 / 265 / 8900  
Fax +1 / 203 / 265 / 8628

Your engineering sales representative:

# Amphenol

Amphenol-Tuchel Electronics GmbH

August-Haessler-Str. 10 · D-74080 Heilbronn · Germany · Phone +49(0)7131/929-0 · Fax +49(0)7131/929-486 · [www.amphenol.info](http://www.amphenol.info)