

SPECIFICATION FOR APPROVAL

承 認 書

Description : Micro Dynamic Speaker
Kingstate Part No. : KDMG13008L-02
Customer's Model No. : _____
Specification No. : PKD-2261
Number Of The Edition : 1.3

CUSTOMER'S APPROVED SIGNATURE		

志豐電子股份有限公司 KINGSTATE ELECTRONICS CORP.



Address: 10F, No. 69-11, Sec. 2, Chung Cheng E. Rd., Tamshui County, Taipei Hsien, Taiwan, R.O.C.

International sales dept.: TEL:886-2-2809-5651 FAX:886-2-2809-7151

Domestic sales dept.: TEL:886-2-2809-0668 FAX:886-2-28096748

<http://www.kingstate.com.tw>

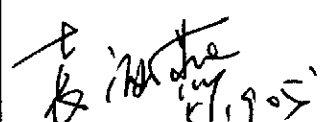
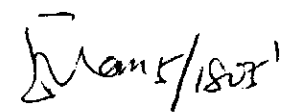
Approved by	Checked by	Issued by
		JIR 5/18/05'

A. SCOPE 範疇

This specification applies speaker , **KDMG13008L-02**
此規格書適用於喇叭 , **KDMG13008L-02**

B. SPECIFICATION 規格

No.	Item	Symbol	Unit	Specification	Condition
1	Dimension 尺寸		mm	13.0 x 2.0	
2	Power Rating 功率		W	Rated. 0.2 / MAX. 0.4	Maximum Power:IEC-60268-5 Filter 60s On/120s Off 10 Cycles (Room TEMP.)
3	Impedance 阻抗		ohm	8 ± 15%	At 1.5kHz 1.0V
4	Resonance Frequency 低音諧振	Fo	Hz	1050 ± 20%	At 1.0V
5	Output S.P.L. 音壓位準		dB	86 ± 3dB(0.2w/10cm) 75 ± 3dB(1w/1m)	At 1.5k,2.0k,2.5k,3.0kHz (Average figures)
6	Frequency Rang 有效頻寬		Hz	Fo---20K	
7	Distortion 失真		%	10% Max.	At 1.5kHz , 0.2W
8	Voice Coil 音圈		mm	-----	
9	Magnet 磁石		mm	7.0 x 0.7	Nd-Fe-B (鈹鐵錳)
10	Flux Density 磁通密度		Gauss	2200	
11	Operating temp. 操作溫度			- 20 ~ +55	
12	Buzze & Rattle 異常音				Not be audible at 1.26V sine wave between Fo ~ 20KHz 輸入 1.26V 正弦波從 Fo 到 20KHz 之間無異常音
13	Weight 重量		g	0.7	
14	Material 材質			Metal	
15	Environmental Protection Regulation 環保法規			RoHS	

C. TYPICAL FREQUENCY RESPONSE CURVE 頻率響應曲線

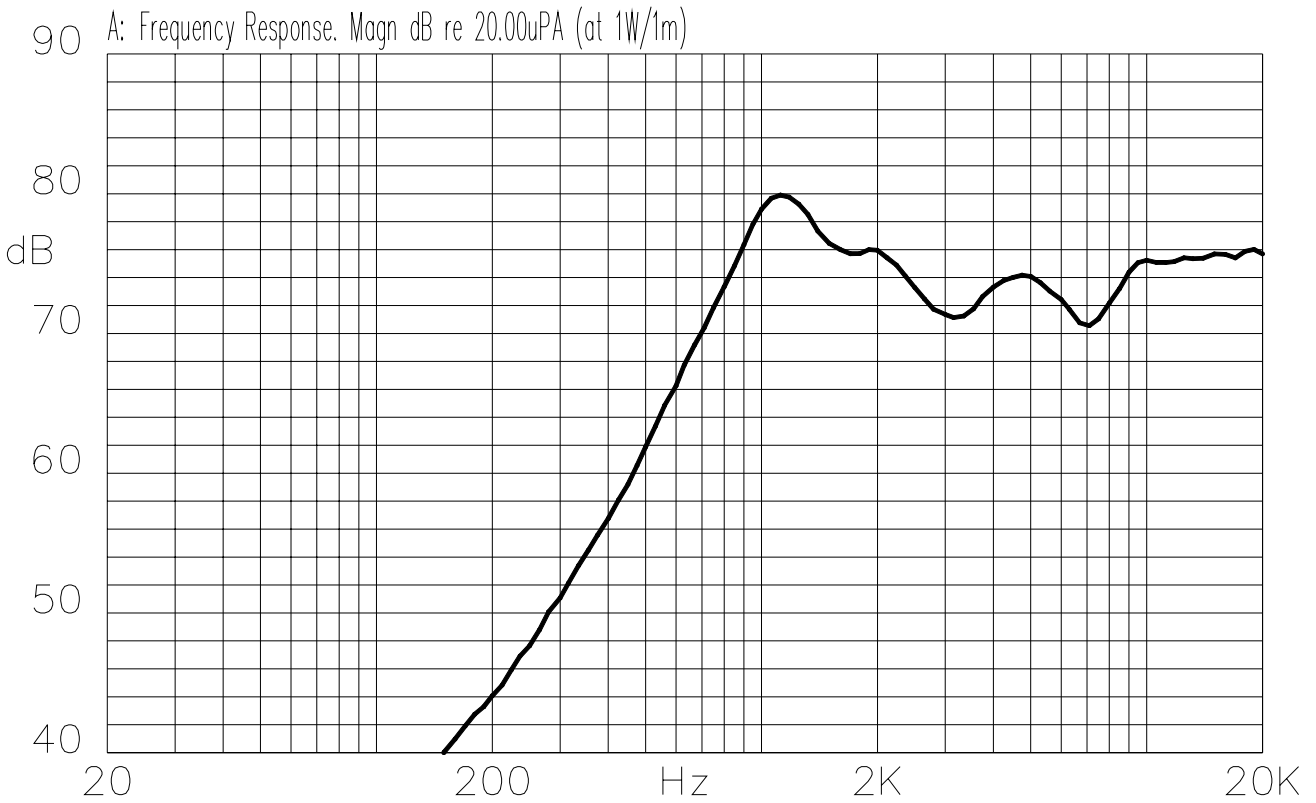
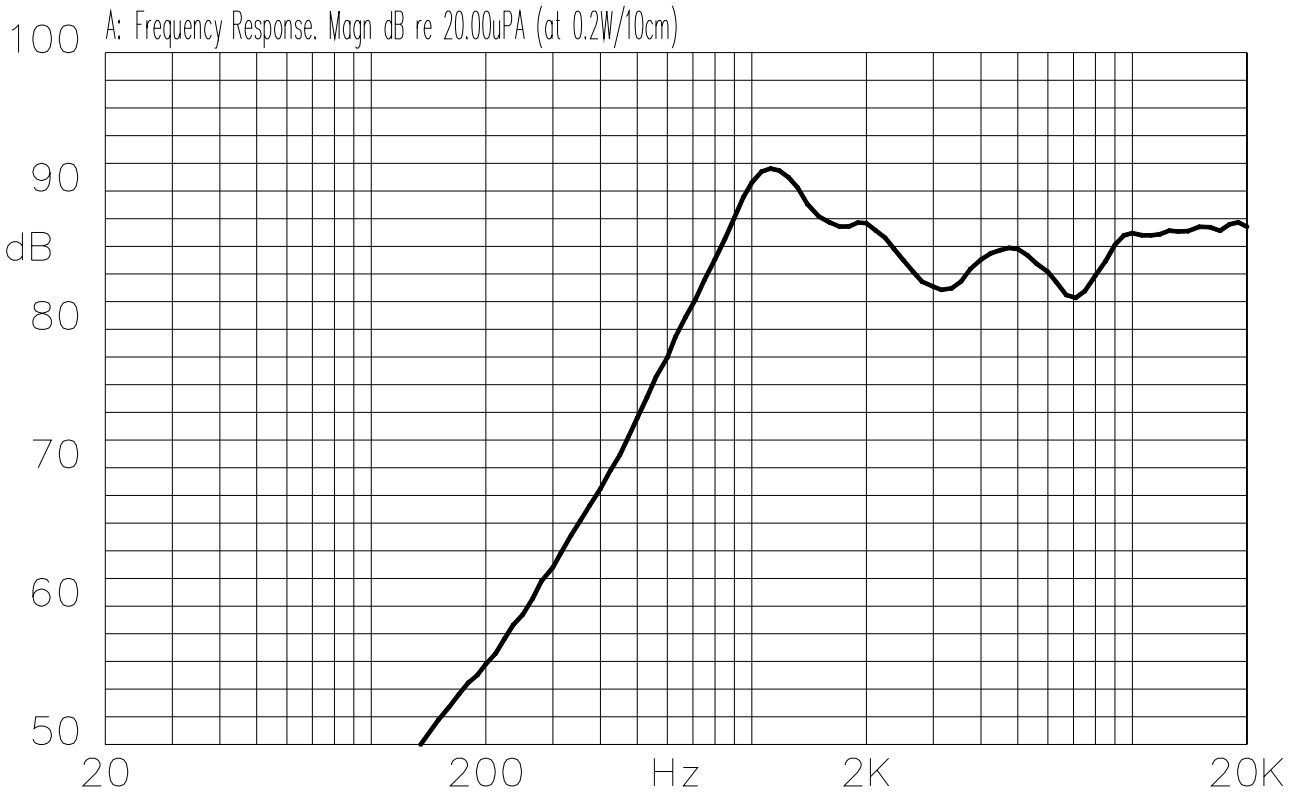

D. APPEARANCE DRAWING 外觀尺寸圖

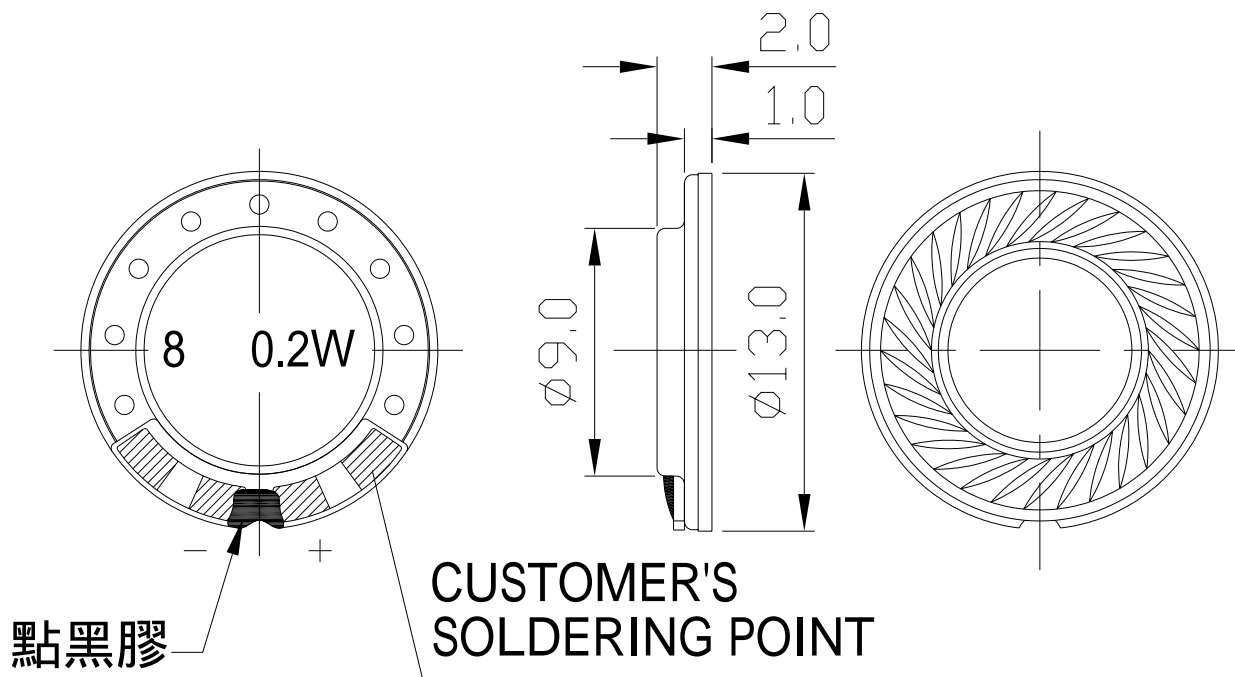

Tol: ± 0.3
Unit : mm

E. MEASUREMENT CIRCUIT 測量線路

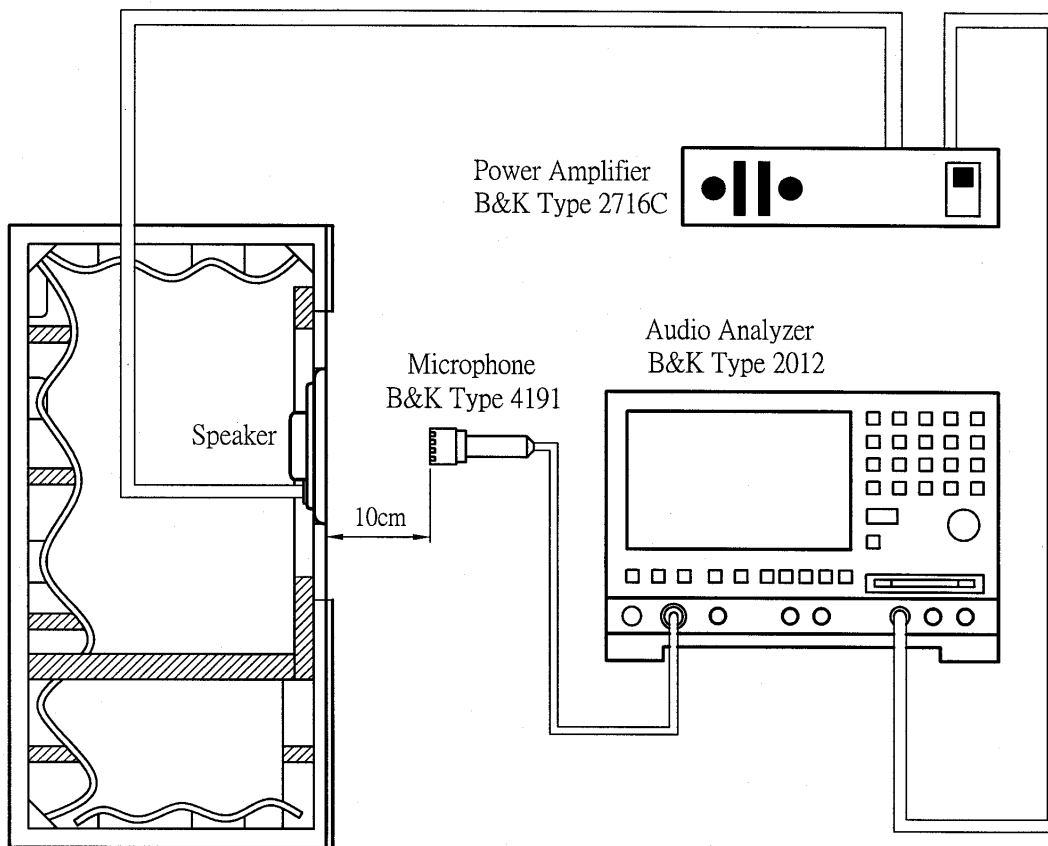

JIS C5531
940mm x 640mm x 1240mm

F. MECHANICAL CHARACTERISTICS 機械特性

No.	Item	Test condition	Evaluation standard
1	Terminal strength 端子強度	Applied 1.0kg load to the terminal for 30 sec. 對端子施以 1.0kg 拉力 30 秒	No damage and cutting off. 線材不鬆動, 不脫落.
2	Vibration Test 振動測試	Speaker shall be measured after being applied vibration of amplitude of 1.52mm with 10 to 55Hz band of vibration frequency to each of 3 per-pendicular directions for 2 hours. 振動週波數 10 ~ 55Hz、全振幅 1.52mm 於 X.Y.Z 3 個方向, 各 2 小時	No obstacle to be harmful to normal operation; damages, cracks, rusts and distortions. Should not be audible at 1.26V sine wave between Fo ~ 20KHz
3	Drop Test 落下測試	Drop the speakers contained in normal box onto the board 40mm thick 10 times from the height of 75cm 將揚聲器置於盒中, 自 75 公分高度落在 40mm 木板上共 10 次	測試後無任何障礙防礙正常操作. 且在輸入 1.26V 正弦波從 Fo 到 20KHz 之間無異常音

G. ENVIRONMENTAL TEST 環境試驗

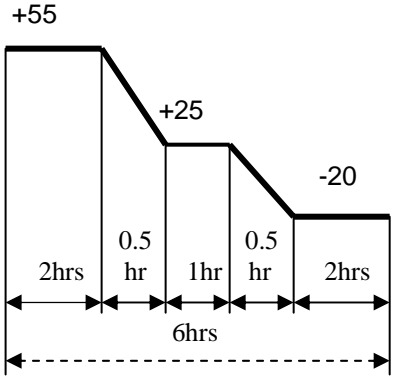
No.	Item	Test conditions	Evaluation standard
1	High temp. Test 高溫測試	After being placed in a chamber at +55 for 96 hours 置於+55 環境中 96 小時	Being placed for 6 hours at +25, speaker shall be measured. No obstacle to be harmful to normal operation; damages, cracks, rusts, etc. Should not be audible at 1.26V sine wave between Fo ~ 20KHz. Fo should meet initial one. S.P.L. deviation of unit should be within $\pm 3\text{dB}$ 經測試後, 靜置於+25 (室溫)環境中 6 小時後, 測試後無任何障礙防礙正常操作. 且在輸入 1.26V 正弦波從 Fo 到 20KHz 之間無異常音. Fo 與原規格值相同輸出音壓變化量在 $\pm 3\text{dB}$ 內
2	Low temp. Test 低溫測試	After being placed in a chamber at -20 for 96 hours. 置於-20 環境中 96 小時	
3	Humidity test 相對濕度測試	After being placed in a chamber at +40 and 90 \pm 5% RH relative humidity for 96 hours. 置於+40, 相對濕度 90 \pm 5%環境中 96 小時	
4	Temp. cycle test 溫度循環測試	The part shall be subjected to 5 cycles. One cycle shall be consist of: 單體承受溫度循環測試 5 次, 其循環內容如圖示: 	

H. RELIABILITY TEST 信賴性試驗

No.	Item	Test conditions	Evaluation standard
1	Load test 連續負荷	0.2W white noise is applied for 96 hours 輸入功率 0.2W, 連續操作 96 小時	No obstacle to be harmful to normal operation; damages, cracks, rusts, etc. Should not be audible at 1.26V sine wave between Fo ~ 20KHz. Fo should meet initial one. S.P.L. deviation of unit should be within $\pm 3\text{dB}$ 測試後無任何障礙防礙正常操作. 且在輸入 1.26V 正弦波從 Fo 到 20KHz 之間無異常音. Fo 與原規格值相同輸出音壓變化量在 $\pm 3\text{dB}$ 內

TEST CONDITION.

Standard Test Condition :	a) Temperature : +5 ~ +35	b) Humidity : 45-85%	c) Pressure : 860-1060mbar
一般測試條件 :	a) 溫度 : +5 ~ +35	b) 濕度 : 45-85%	c) 氣壓 : 860-1060mbar
Judgement Test Condition	a) Temperature : +25 \pm 2	b) Humidity : 60-70%	c) Pressure : 860-1060mbar
爭議時測試條件:	a) 溫度 : +25 \pm 2	b) 濕度 : 60-70%	c) 氣壓 : 860-1060mbar

I. PACKING STANDARD 包裝規格

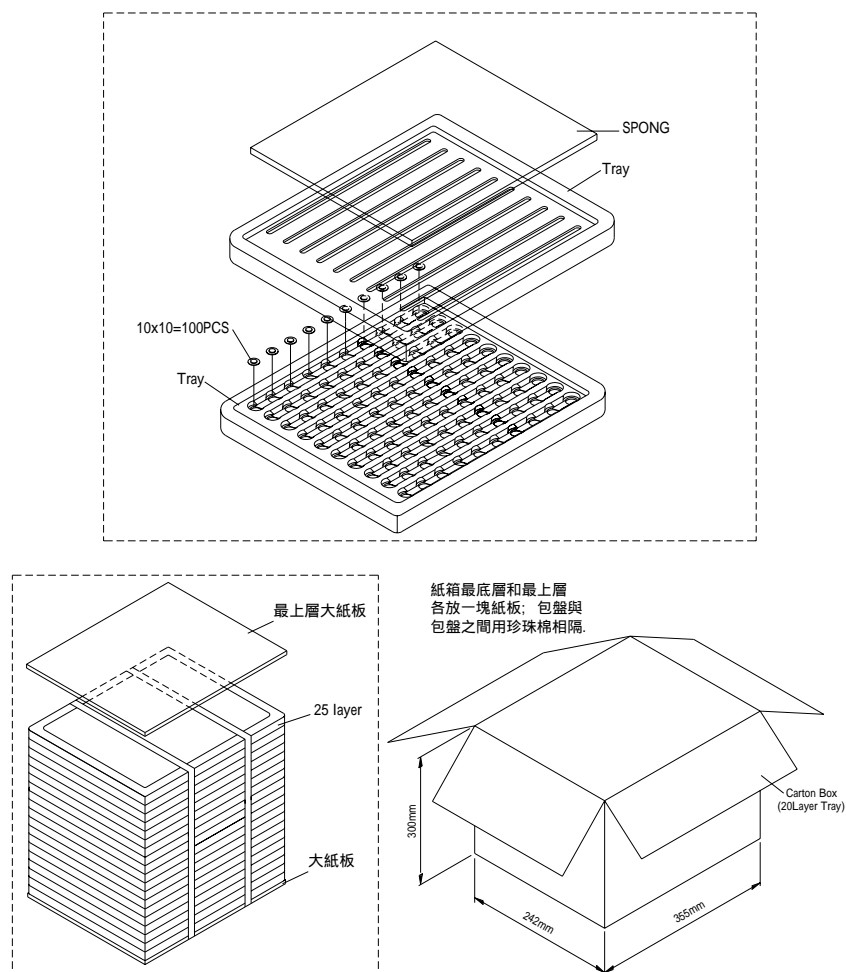

Tray	350mmx235mmx20mm	1x100PCS=100PCS
Carton Box	355mmx242mmx300mm	100PCSx20=2,000PCS