

# ASMT-MW09

## 1W Power LED Light Source



### Data Sheet



Lead (Pb) Free  
RoHS 6 fully  
compliant

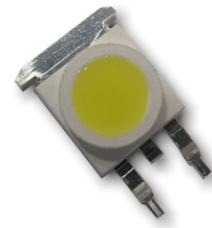

#### Description

1W Power LED Light Source is a high performance energy efficient device which can handle high thermal and high driving current. The exposed pad design has excellent heat transfer from the package to the motherboard.

The Cool White Power LED is available in various color temperature ranging from 4000K to 10000K.

The package is compatible with reflow soldering. This will give more freedom and flexibility to the light source designer.

#### Applications

- Portable (flash light, bicycle head light)
- Reading light
- Architectural lighting
- Garden lighting
- Decorative lighting

#### Features

- Available in Cool White color.
- Energy efficient
- Exposed pad for excellent heat transfer.
- Suitable for reflow soldering process.
- High current operation.
- Long operation life.
- Wide viewing angle.
- Silicone encapsulation
- ESD of 16kV
- MSL 4

#### Specifications

- InGaN Technology
- 3.5V, 350 mA (typical)
- 120 viewing angle

## Package Dimensions

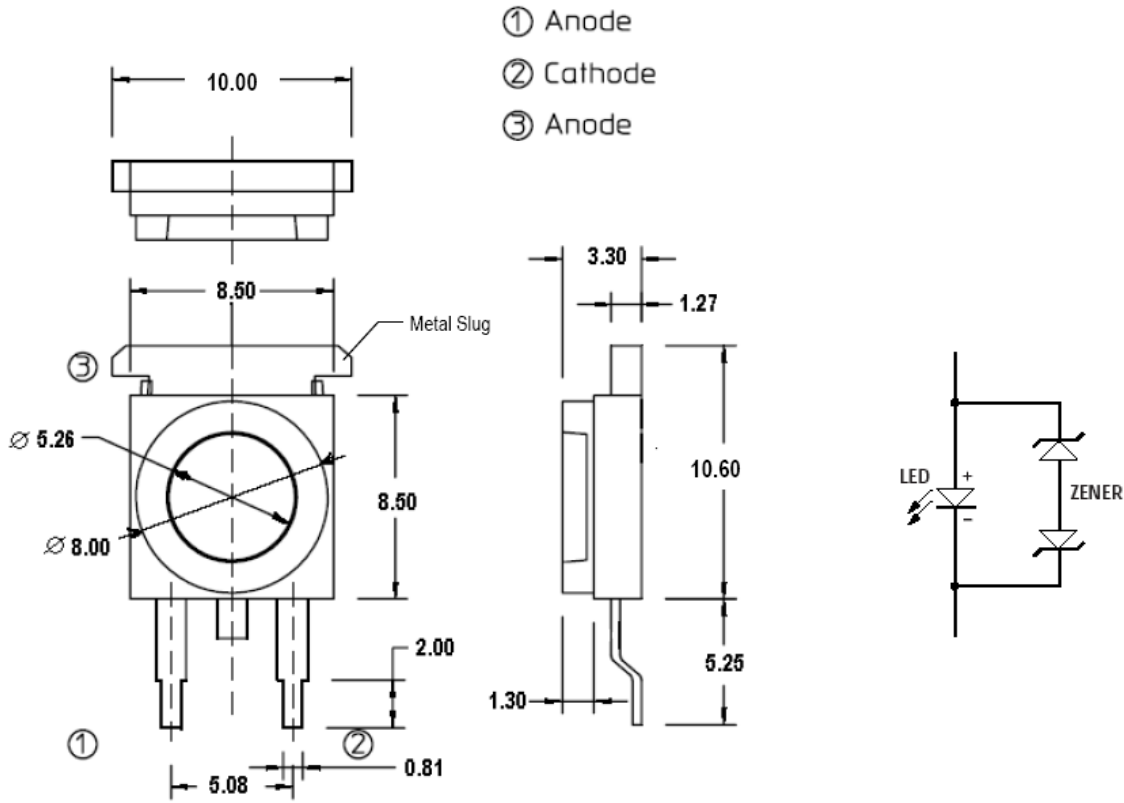

NOTES:  
1. ALL DIMENSIONS IN MILLIMETERS.  
2. TOLERANCE IS  $\pm 0.1$  MM UNLESS OTHERWISE SPECIFIED.

## Device Selection Guide at Junction Temperature $T_j = 25^\circ\text{C}$

Color	Part Number	Luminous Flux, $\Phi_v^{[1,2,3]}$ (lm)			Test Current (mA)	Dice Technology
		Min	Typ	Max		
Cool White	ASMT-MW09	56.0	80.0	95.0	350	InGaN

Notes:  
1.  $\Phi_v$  is the total luminous flux output as measured with an integrating sphere at 25ms mono pulse condition.  
2. Flux tolerance is  $\pm 10\%$

## Part Numbering System

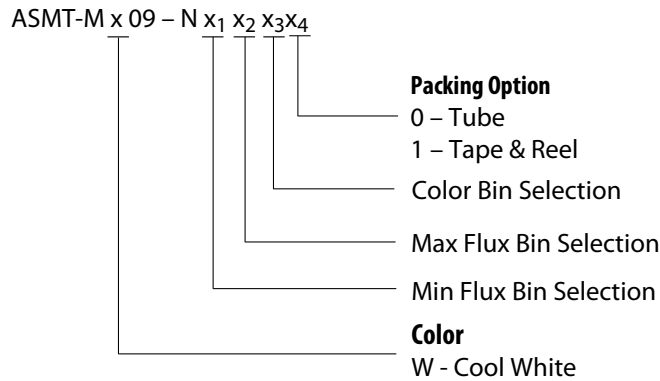

## Absolute Maximum Ratings ( $T_A = 25\text{ }^\circ\text{C}$ )

Parameter	ASMT-Mx09	Units
DC Forward Current	350	mA
Peak Pulsing Current <sup>[1]</sup>	500	mA
Power Dissipation	1400	mW
LED Junction Temperature	125	$^\circ\text{C}$
Operating Ambient Temperature Range	-40 to +100	$^\circ\text{C}$
Storage Temperature Range	-40 to +120	$^\circ\text{C}$
Soldering Temperature	Refer to figure 7	

Note:

1. Pulse condition duty factor = 10%, Frequency = 1kHz.

## Optical Characteristics ( $T_A = 25\text{ }^\circ\text{C}$ )

Part Number	Color	Correlated Color Temperature, CCT (Kelvin)		Viewing Angle $2\theta_{1/2}$ <sup>[2]</sup> (Degrees)	Luminous Efficiency (lm/W)
		Min	Max	Typ	Typ
ASMT-MW09	Cool White	4000	10000	120	63

Notes:

2.  $\theta_{1/2}$  is the off-axis angle where the luminous intensity is  $1/2$  the peak intensity.

## Electrical Characteristic ( $T_A = 25\text{ }^\circ\text{C}$ )

Dice Type	Forward Voltage $V_F$ (Volts) @ $I_F = 350\text{mA}$		Reverse Voltage $V_R$ (Volts)	Thermal Resistance $R_{\theta j-b}$ ( $^\circ\text{C/W}$ ) <sup>[1]</sup>
	Typ	Max.	Max.	Typ.
InGaN	3.6	4.0	5	10

Note:

1. Not designed for reverse bias operation.
2.  $R_{\theta j-ms}$  is Thermal Resistance from LED junction to metal slug.

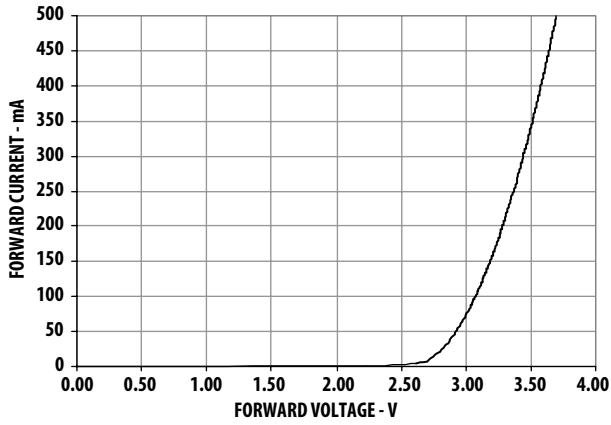

Figure 1. MS LEAP Cool White Forward Voltage vs. Forward Current

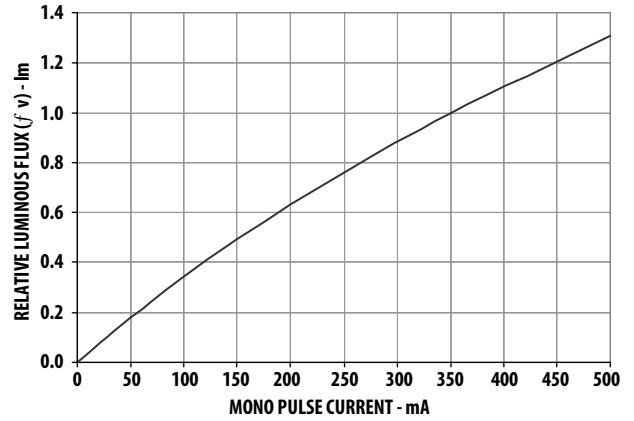

Figure 2. MS LEAP Relative Luminous Intensity vs. Forward Current

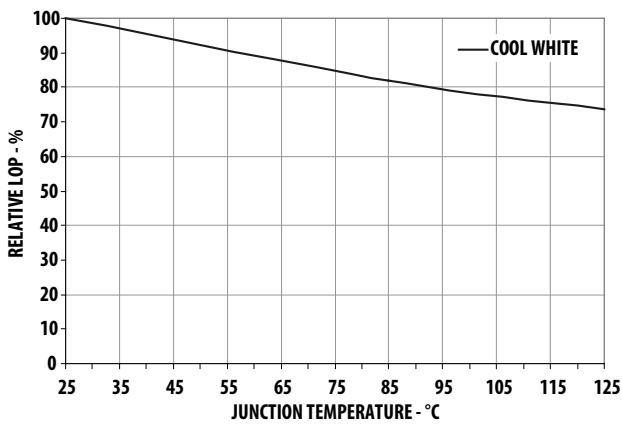

Figure 3. LOP (%) Vs Temperature(°C)

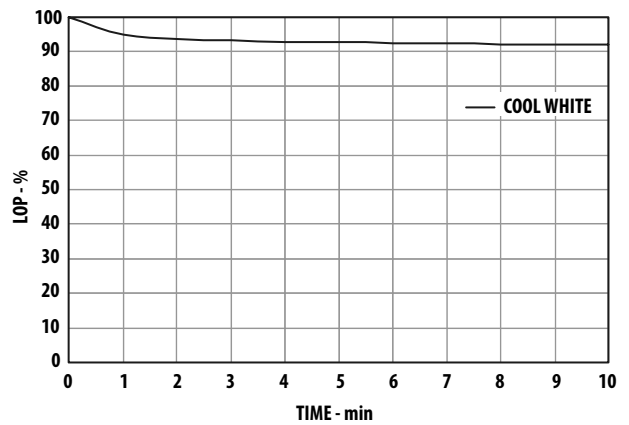

Figure 4. LOP (%) Vs Light Up Time(Min)

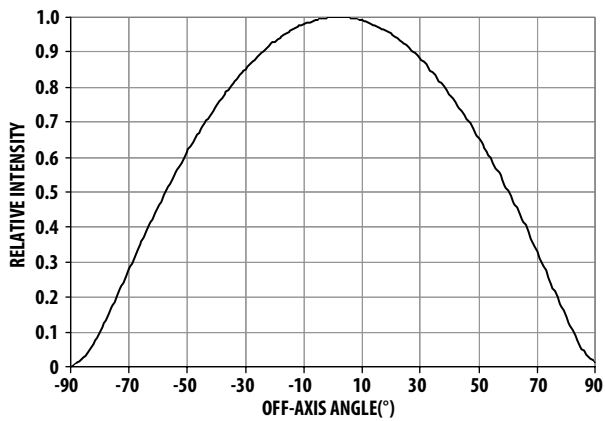

Figure 5. Cool White Radiation Pattern

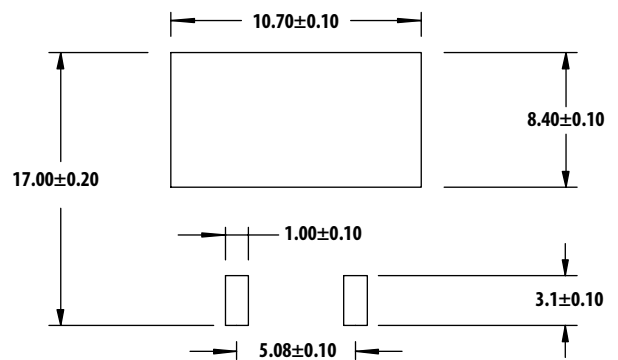

Figure 6. Recommended soldering land pattern

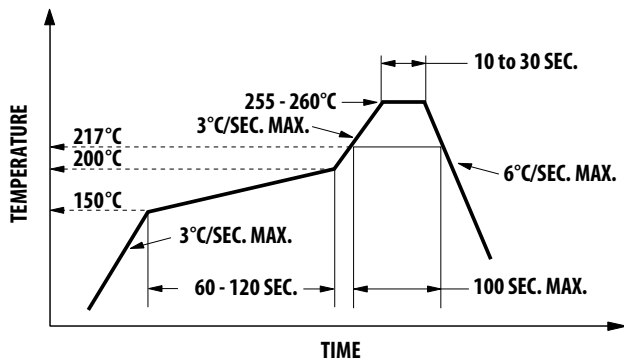

Figure 7. Recommended Reflow Soldering

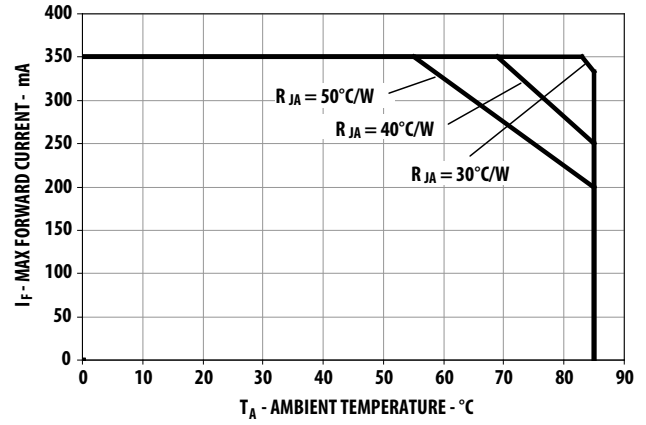

Figure 8. Maximum forward current vs. ambient temperature  
Derated based on  $T_{JMAX} = 125^{\circ}\text{C}$ ,  $R_{\theta JA} = 30^{\circ}\text{C/W}$ ,  $40^{\circ}\text{C/W}$  and  $50^{\circ}\text{C/W}$

### Flux Bin Limit (For reference only) [x<sub>1</sub> x<sub>2</sub>]

Bin	Flux (lm) at 350mA	
	Min	Max
K	56.0	73.0
L	73.0	95.0

Tolerance for each bin limits is ±10 %

### Color Bin Selections [x<sub>3</sub>]

Individual reel will contain parts from one full bin only.

Cool White	
0	Full Distribution
A	A only
B	B only
C	C only
D	D only
E	E only
F	F only
G	G only
H	H only
Z	A and B only
Y	B and C only
W	C and D only
V	D and E only
U	E and F only
T	F and G only
S	G and H only
Q	A, B and C only
P	B, C and D only
N	C, D and E only
M	D, E and F only
L	E, F and G only
K	F, G and H only
J	Special Color Bin
1	A, B, C and D only
2	E, F, G and H only
3	B, C, D and E only
4	C, D, E and F only
5	A, B, C, D and E only
6	B, C, D, E, and F only

### Primary Color Binning

Cool White	Color Limits (Chromaticity Coordinates)				
Bin A	X	0.367	0.362	0.329	0.329
	Y	0.400	0.372	0.345	0.369
Bin B	X	0.362	0.356	0.329	0.329
	Y	0.372	0.330	0.302	0.345
Bin C	X	0.329	0.329	0.305	0.301
	Y	0.369	0.345	0.322	0.342
Bin D	X	0.329	0.329	0.311	0.305
	Y	0.345	0.302	0.285	0.322
Bin E	X	0.303	0.307	0.283	0.274
	Y	0.333	0.311	0.284	0.301
Bin F	X	0.307	0.311	0.290	0.283
	Y	0.311	0.285	0.265	0.284
Bin G	X	0.388	0.379	0.362	0.367
	Y	0.417	0.383	0.372	0.400
Bin H	X	0.379	0.369	0.356	0.362
	Y	0.383	0.343	0.330	0.372

Tolerances ± 0.01

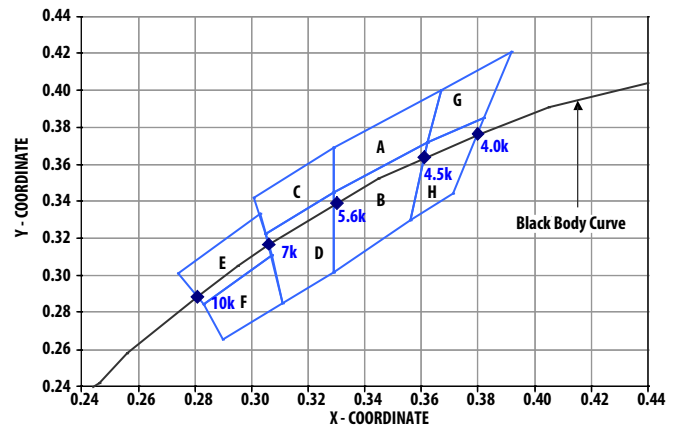

## Sub-Color Binning

(Only Applicable for Color Bin A to Bin D and Bin G to Bin H)

### Color Limits

Cool White	(Chromaticity Coordinates)				
Bin A1	X	0.364	0.367	0.348	0.347
	Y	0.383	0.400	0.385	0.372
Bin A2	X	0.364	0.362	0.346	0.347
	Y	0.383	0.372	0.359	0.372
Bin A3	X	0.329	0.329	0.348	0.347
	Y	0.357	0.369	0.385	0.372
Bin A4	X	0.329	0.329	0.347	0.346
	Y	0.345	0.357	0.372	0.359
Bin B1	X	0.362	0.360	0.344	0.346
	Y	0.372	0.357	0.344	0.359
Bin B2	X	0.360	0.358	0.343	0.344
	Y	0.357	0.343	0.331	0.344
Bin B3	X	0.358	0.356	0.341	0.343
	Y	0.343	0.330	0.314	0.331
Bin B4	X	0.329	0.329	0.346	0.344
	Y	0.331	0.345	0.359	0.344
Bin B5	X	0.329	0.344	0.343	0.329
	Y	0.331	0.344	0.331	0.320
Bin B6	X	0.343	0.341	0.329	0.329
	Y	0.331	0.314	0.302	0.320
Bin C1	X	0.329	0.329	0.315	0.314
	Y	0.369	0.357	0.344	0.355
Bin C2	X	0.329	0.329	0.316	0.315
	Y	0.357	0.345	0.333	0.344
Bin C3	X	0.314	0.315	0.303	0.301
	Y	0.355	0.344	0.333	0.342
Bin C4	X	0.315	0.316	0.305	0.303
	Y	0.344	0.333	0.322	0.333

Cool White	(Chromaticity Coordinates)				
Bin D1	X	0.329	0.329	0.317	0.316
	Y	0.345	0.331	0.320	0.333
Bin D2	X	0.329	0.329	0.318	0.317
	Y	0.331	0.320	0.310	0.320
Bin D3	X	0.329	0.329	0.320	0.318
	Y	0.320	0.302	0.293	0.310
Bin D4	X	0.316	0.317	0.307	0.305
	Y	0.333	0.320	0.311	0.322
Bin D5	X	0.317	0.318	0.309	0.307
	Y	0.320	0.310	0.300	0.311
Bin D6	X	0.318	0.320	0.311	0.309
	Y	0.310	0.293	0.285	0.300
Bin G1	X	0.392	0.386	0.364	0.367
	Y	0.421	0.400	0.383	0.400
Bin G2	X	0.386	0.382	0.362	0.364
	Y	0.400	0.385	0.372	0.383
Bin H1	X	0.382	0.378	0.360	0.362
	Y	0.385	0.370	0.357	0.372
Bin H2	X	0.378	0.375	0.358	0.360
	Y	0.370	0.358	0.343	0.357
Bin H3	X	0.375	0.371	0.356	0.358
	Y	0.358	0.344	0.330	0.343

Tolerances  $\pm 0.01$

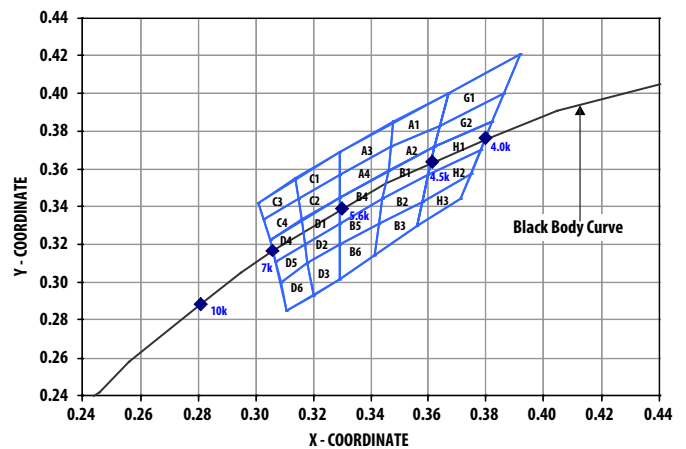

### Packing Tube - Option 0

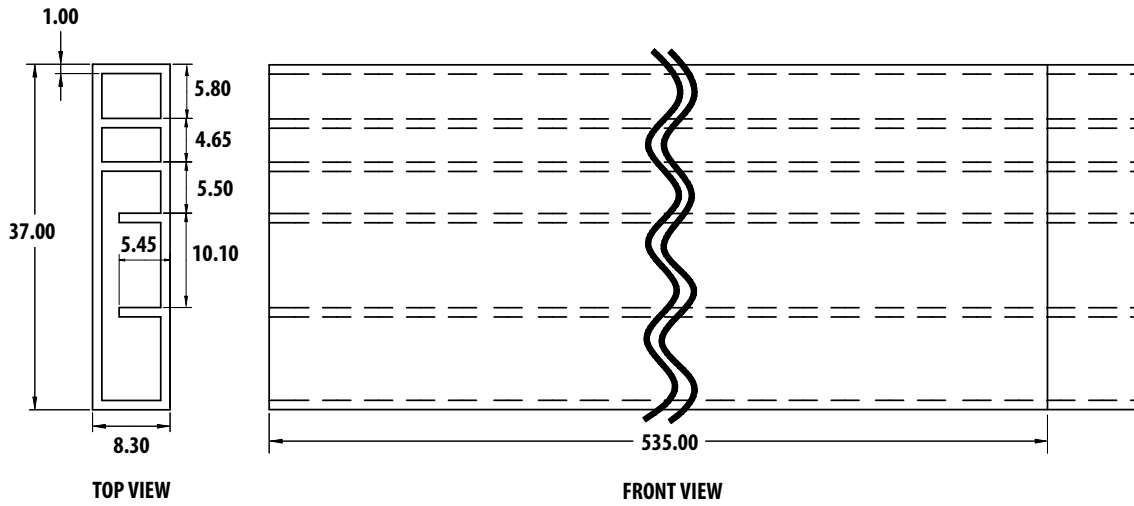

### Tape & Reel - Option 1

#### Tape Dimension

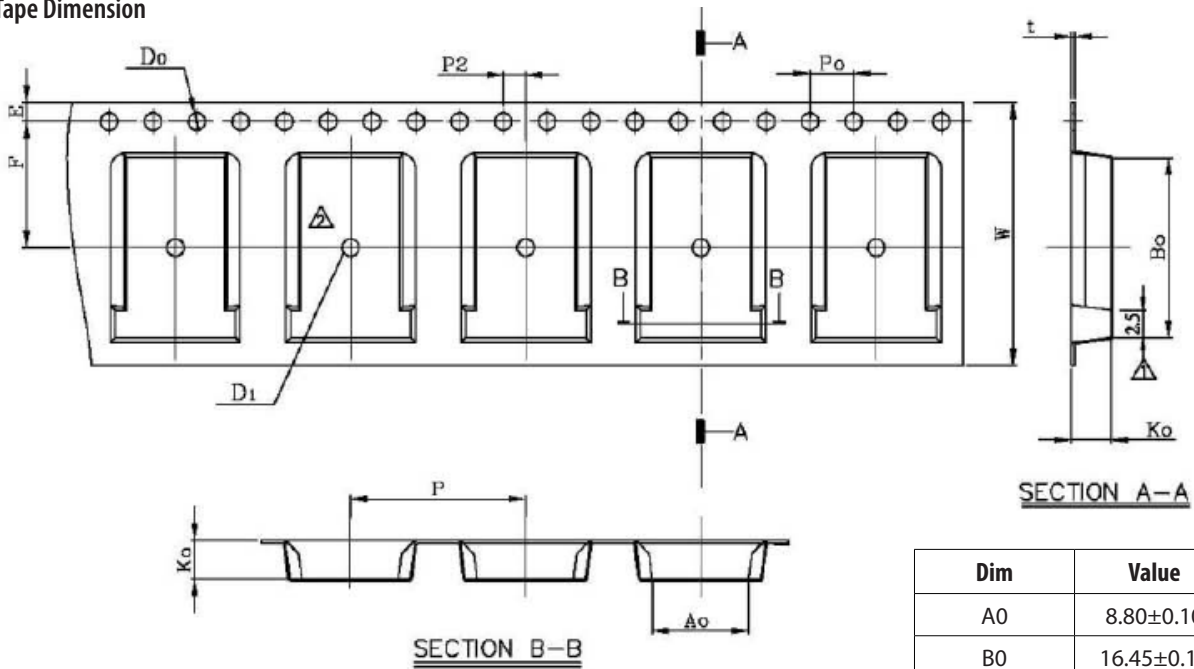

Dim	Value
A0	8.80±0.10
B0	16.45±0.10
K0	3.60±0.10
W	24.0±0.10
P	16.0±0.10
Qty/Reel	250EA

Unit: mm

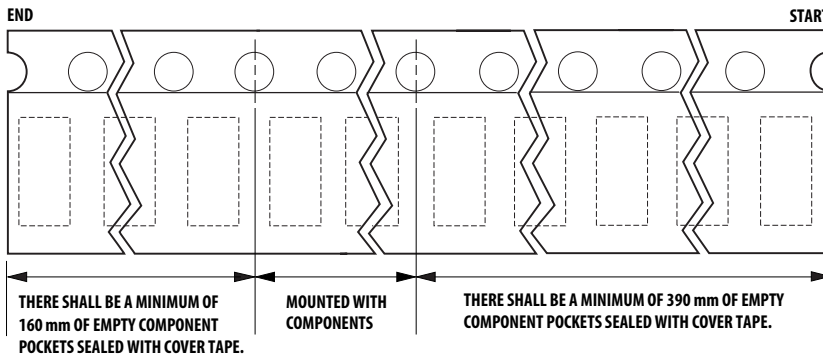



## Reel Dimension

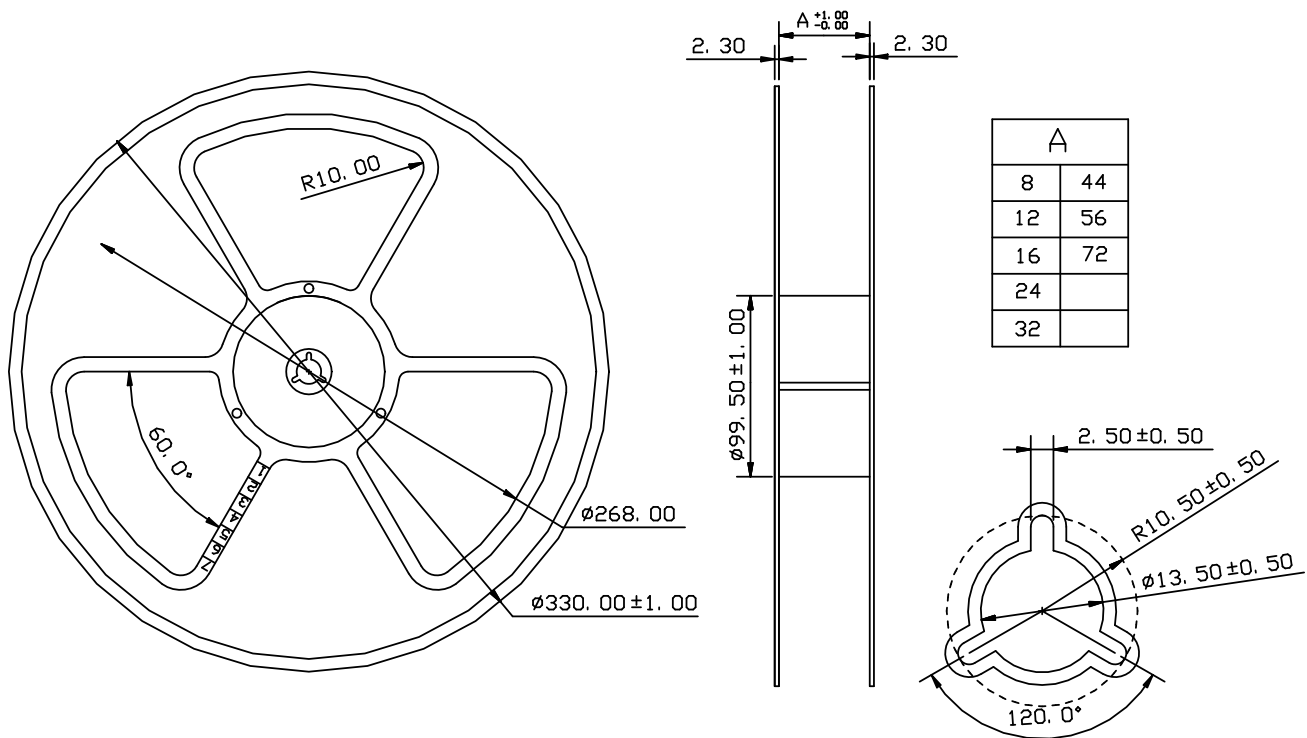

## Handling Precaution

The encapsulation material of the product is made of silicone for better reliability of the product. As silicone is a soft material, please do not press on the silicone or poke a sharp object onto the silicone. These might damage the product and cause premature failure. During assembly or handling, the unit should be held on the body (white epoxy).

This product is classified as moisture sensitive level 4

When the bag is opened, parts required to mount within 72 hours of factory conditions  $\leq 30^\circ\text{C}/60\%$ , and stored at  $<10\%$  RH.

Devices required bake, before mounting if:

- The humidity indicator card is  $> 10\%$  when read at  $23 \pm 5^\circ\text{C}$
- The pack has been opened for more than 72 hours.

Baking recommended condition:  $60 \pm 5^\circ\text{C}$  for 20 hours.

**DISCLAIMER:** AVAGO'S PRODUCTS AND SOFTWARE ARE NOT SPECIFICALLY DESIGNED, MANUFACTURED OR AUTHORIZED FOR SALE AS PARTS, COMPONENTS OR ASSEMBLIES FOR THE PLANNING, CONSTRUCTION, MAINTENANCE OR DIRECT OPERATION OF A NUCLEAR FACILITY OR FOR USE IN MEDICAL DEVICES OR APPLICATIONS. CUSTOMER IS SOLELY RESPONSIBLE, AND WAIVES ALL RIGHTS TO MAKE CLAIMS AGAINST AVAGO OR ITS SUPPLIERS, FOR ALL LOSS, DAMAGE, EXPENSE OR LIABILITY IN CONNECTION WITH SUCH USE.

For product information and a complete list of distributors, please go to our web site: [www.avagotech.com](http://www.avagotech.com)

Avago, Avago Technologies, and the A logo are trademarks of Avago Technologies Limited in the United States and other countries. Data subject to change. Copyright © 2008 Avago Technologies Limited. All rights reserved. AV02-1096EN - April 9, 2008

**AVAGO**  
TECHNOLOGIES