

QLZ06/1800-2518

AC tangential blower

forward curved



ebm-papst Landshut GmbH

Hofmark-Aich-Straße 25

84030 Landshut

Phone: +49 871 707-0

Fax: +49 871 707-465

www.ebmpapst.com

info3@de.ebmpapst.com

Nominal data

Type	QLZ06/1800-2518	
Nominal voltage	[VAC]	230
Frequency	[Hz]	50
Speed	[min ⁻¹]	1350
Power input	[W]	24
Current draw	[A]	220
Max. back pressure	[Pa]	58
Min. ambient temperature	[°C]	0
Max. ambient temperature	[°C]	60
Air flow	[m ³ /h]	120

ml = max. load · me = max. efficiency · rfa = running at free air · cs = customer specs · cu = customer unit
Subject to alterations

Technical features

Dimensions	60 mm
Connection line	Flat plug 6.3 x 0.8
Line	Standard
Mounting position	Horizontal or vertical with motor below
Insulation class	B F or H also available on request
Mass	0.90 kg

Product drawing

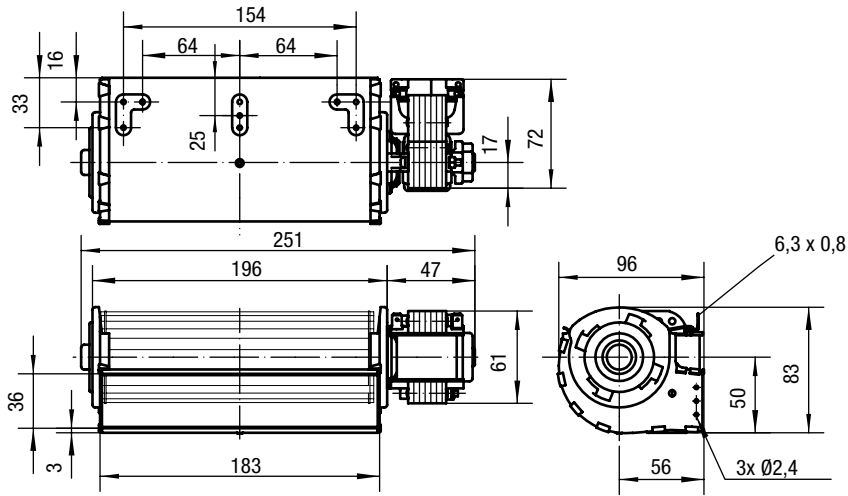

Charts: Air flow

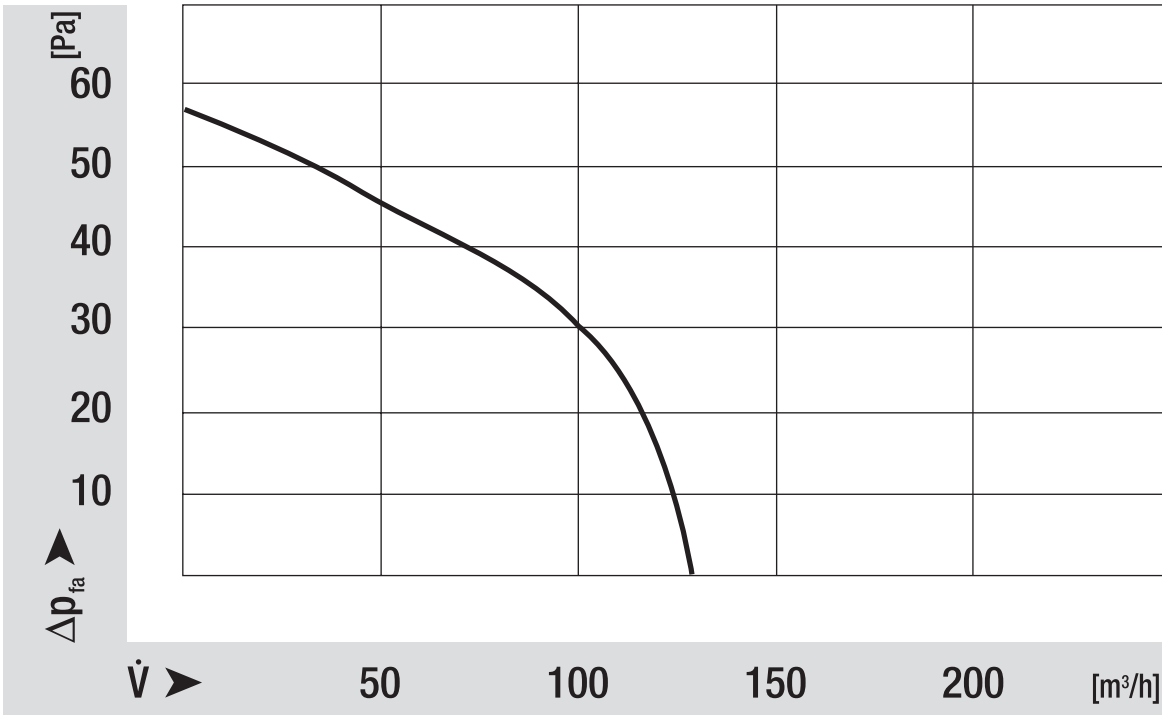

Charts: Speed

