

PTSA 0,5/ 9-2,5-Z

Order No.: 1990070

The figure shows a 10-position version of the product

<http://eshop.phoenixcontact.net/phoenix/treeViewClick.do?UID=1990070>

PC terminal block, Nominal current: 2 A, Nom. voltage: 160 V, Pitch: 2.5 mm, Number of positions: 9, Type of connection: Spring-cage conn., Assembly: Soldering, Conductor/PCB connection direction: 45 °, Color: green, Offset soldering legs, two-rowed

Commercial data

EAN	4017918973643
Pack	100 pcs.
Customs tariff	85369010
Weight/Piece	0.003524 KG
Catalog page information	Page 459 (CC-2009)

Product notes

WEEE/RoHS-compliant since:
01/29/2004

<http://www.download.phoenixcontact.com>
Please note that the data given here has been taken from the online catalog. For comprehensive information and data, please refer to the user documentation. The General Terms and Conditions of Use apply to Internet downloads.

Technical data

Dimensions / positions

Pitch	2.5 mm
Dimension a	20 mm
Number of positions	9

Pin dimensions	0,4 x 0,75
Pin spacing	2.5 mm
Hole diameter	1 mm

Technical data

Insulating material group	I
Rated surge voltage (III/3)	2.5 kV
Rated surge voltage (III/2)	2.5 kV
Rated surge voltage (II/2)	2.5 kV
Rated voltage (III/2)	250 V
Rated voltage (II/2)	400 V
Connection in acc. with standard	EN-VDE
Nominal current I_N	2 A
Nominal voltage U_N	160 V
Nominal cross section	0.5 mm ²
Maximum load current	2 A
Insulating material	PA
Inflammability class acc. to UL 94	V0
Stripping length	9 mm

Connection data

Conductor cross section solid min.	0.14 mm ²
Conductor cross section solid max.	0.5 mm ²
Conductor cross section stranded min.	0.2 mm ²
Conductor cross section stranded max.	0.5 mm ²
Conductor cross section AWG/kcmil min.	24
Conductor cross section AWG/kcmil max	20

Certificates / Approvals



Certification CCA, CUL, UL, VDE-PZI

CUL

Nominal voltage U_N	300 V
-----------------------	-------

Nominal current I_N	2 A
AWG/kcmil	26-20
UL	
Nominal voltage U_N	300 V
Nominal current I_N	2 A
AWG/kcmil	26-20

Diagrams/Drawings

Drilling plan/solder pad geometry

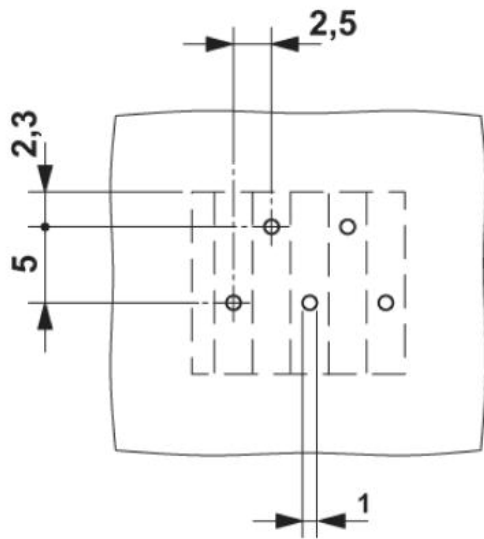

The illustration shows the 5-pos. version – Zig-zag pinning starts at the right-hand position. Other pinning available on request.

Diagram

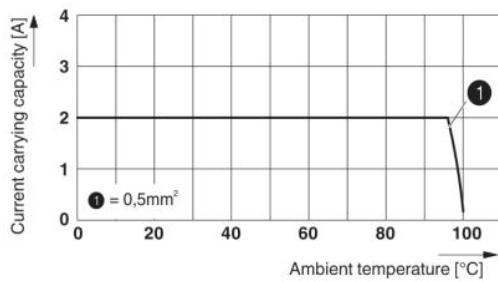

Derating diagram for 5 pins; reduction factor=1

Dimensioned drawing

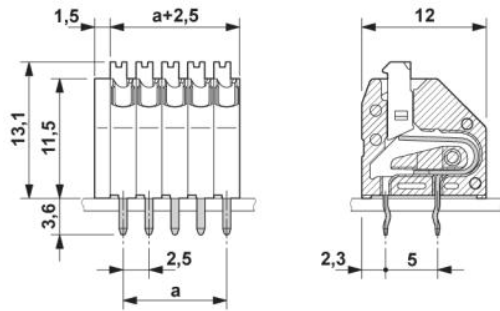

The illustration shows the 5-pos. version

Address

PHOENIX CONTACT GmbH & Co. KG
Flachsmarktstr. 8
32825 Blomberg, Germany
Phone +49 5235 3 00
Fax +49 5235 3 41200
<http://www.phoenixcontact.com>



© 2010 Phoenix Contact
Technical modifications reserved;