

## GMSTBVA 2,5/ 2-G-7,62

Order No.: 1766770

The figure shows a 10-position version of the product

<http://eshop.phoenixcontact.net/phoenix/treeViewClick.do?UID=1766770>Header, Nominal current: 12 A, Nom. voltage: 400 V, Pitch: 7.62 mm,  
Number of positions: 2, Color: green, Assembly: Soldering

### Commercial data

EAN	4017918032791
Pack	50 pcs.
Customs tariff	85366990
Weight/Piece	0.001278 KG
Catalog page information	Page 277 (CC-2009)

### Product notes

WEEE/RoHS-compliant since:  
01/01/2003

<http://www.download.phoenixcontact.com>  
Please note that the data given here has been taken from the online catalog. For comprehensive information and data, please refer to the user documentation. The General Terms and Conditions of Use apply to Internet downloads.

### Technical data

#### Dimensions / positions

Length	8.6 mm
Pitch	7.62 mm
Dimension a	7.62 mm
Number of positions	2
Pin dimensions	1 x 1 mm

Hole diameter	1.4 mm
<b>Technical data</b>	
Insulating material group	I
Rated surge voltage (III/3)	6 kV
Rated surge voltage (III/2)	6 kV
Rated surge voltage (II/2)	6 kV
Rated voltage (III/2)	630 V
Rated voltage (II/2)	630 V
Connection in acc. with standard	EN-VDE
Nominal current $I_N$	12 A
Nominal voltage $U_N$	400 V
Maximum load current	12 A
Insulating material	PA
Inflammability class acc. to UL 94	V0

#### Certificates / Approvals



Certification CB, CSA, CUL, GOST, UL, VDE-PZI

#### CSA

Nominal voltage $U_N$	300 V
Nominal current $I_N$	10 A

#### CUL

Nominal voltage $U_N$	300 V
Nominal current $I_N$	10 A

#### UL

Nominal voltage $U_N$	300 V
Nominal current $I_N$	10 A

**Accessories**

Item	Designation	Description
<b>Assembly</b>		
1755477	MSTB-BL	Keying cap, for forming sections, plugs onto header pin, green insulating material
<b>Marking</b>		
0804549	SK 7,62/3,8:FORTL.ZAHLEN	Marker card, printed horizontally, self-adhesive, 10-section marker strip, 12 identical decades marked 1-10, 11-20 etc. up to 91-99, sufficient for 120 terminal blocks
<b>Plug/Adapter</b>		
1734401	CR-MSTB	Coding section, inserted into the recess in the header or the inverted plug, red insulating material

**Additional products**

Item	Designation	Description
<b>General</b>		
1806119	FRONT-GMSTB 2,5/ 2-ST-7,62	Plug component, Nominal current: 12 A, Nom. voltage: 400 V, Pitch: 7.62 mm, Number of positions: 2, Connection type: Screw connection, Color: green
1828676	GIC 2,5/ 2-G-7,62	Header, Nominal current: 12 A, Nom. voltage: 500 V, Pitch: 7.62 mm, Number of positions: 2, Color: green, Assembly: Soldering
1828919	GICV 2,5/ 2-G-7,62	Header, Nominal current: 12 A, Nom. voltage: 500 V, Pitch: 7.62 mm, Number of positions: 2, Color: green, Assembly: Soldering
1766990	GMSTB 2,5/ 2-ST-7,62	Plug component, Nominal current: 12 A, Nom. voltage: 400 V, Pitch: 7.62 mm, Number of positions: 2, Connection type: Screw connection, Color: green
1832523	GMVSTBR 2,5/ 2-ST-7,62	Plug component, Nominal current: 12 A, Nom. voltage: 500 V, Pitch: 7.62 mm, Number of positions: 2, Connection type: Screw connection, Color: green
1832413	GMVSTBW 2,5/ 2-ST-7,62	Plug component, Nominal current: 12 A, Nom. voltage: 500 V, Pitch: 7.62 mm, Number of positions: 2, Connection type: Screw connection, Color: green

## Diagrams/Drawings

Drilling plan/solder pad geometry

---

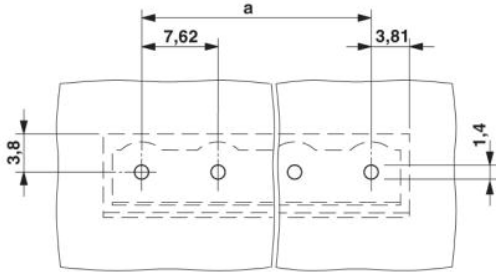

Dimensioned drawing

---

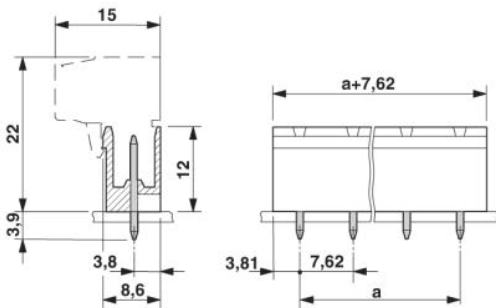

**Address**

PHOENIX CONTACT GmbH & Co. KG  
Flachsmarktstr. 8  
32825 Blomberg, Germany  
Phone +49 5235 3 00  
Fax +49 5235 3 41200  
<http://www.phoenixcontact.com>



© 2010 Phoenix Contact  
Technical modifications reserved;