

Spezifikation für Freigabe / specification for release

Kunde / customer :
 Artikelnummer / part number : **7447798180**
 Bezeichnung : **SPEICHERDROSSEL WE-PDF**
 description : **POWER-CHOKE WE-PDF**



DATUM / DATE : 2009-12-01

A Mechanische Abmessungen / dimensions :

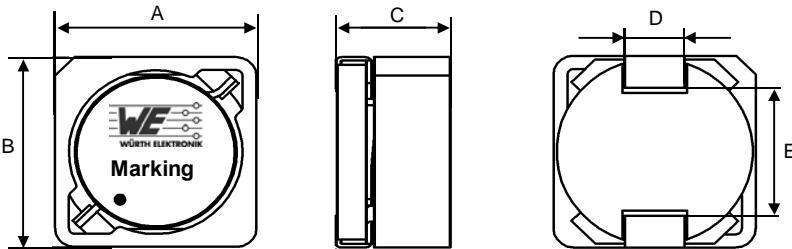

● Start of winding Marking = Inductance code

size 1064		
A	10,2 ± 0,3	mm
B	10,2 ± 0,3	mm
C	6,4 max.	mm
D	3,0 ± 0,2	mm
E	6,8 ± 0,5	mm

B Elektrische Eigenschaften / electrical properties :

Eigenschaften / properties	Testbedingungen / test conditions		Wert / value	Einheit / unit	tol.
Induktivität / inductance	100 kHz / 5mA	L	1,80	µH	±30%
DC-Widerstand / DC-resistance	@ 20°C / 1A	R _{DC typ}	8,5	mΩ	typ.
DC-Widerstand / DC-resistance	@ 20°C / 1A	R _{DC max}	9,6	mΩ	max.
Nennstrom / rated current	ΔT=40 K	I _{DC}	9,00	A	typ.
Sättigungsstrom / saturation current	 ΔL/L <10%	I _{sat}	12,80	A	typ.
Eigenres.-frequenz / self-res.-frequency		SRF	78,0	MHz	typ.

C Lötpad / soldering spec. :

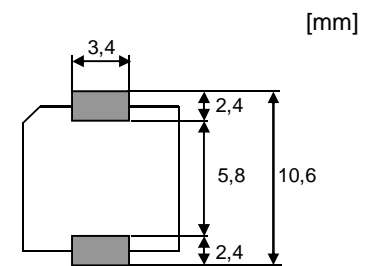

D Prüfgeräte / test equipment :

WK 3260B für/for L und/and I_{DC}
GMC Metrahit 271 für/for R_{DC}
HP E4991A für/for SRF

E Testbedingungen / test conditions :

Luftfeuchtigkeit / humidity: 33%
 Umgebungstemperatur / temperature: +20°C

F Werkstoffe & Zulassungen / material & approvals :

Basismaterial / base material: Ferrit/ferrite
 Endoberfläche / finishing electrode: 100% Sn
 Draht / wire: SFT-EI / AIWJ
 UL-File Number: E318511

G Eigenschaften / general specifications :

Betriebstemp. / operating temperature: -40°C - +150°C
 Umgebungstemp. / ambient temperature: -40°C - +110°C
 It is recommended that the temperature of the part does not exceed 150°C under worst case operating conditions.

Freigabe erteilt / general release:	Kunde / customer		
	Unterschrift / signature		
	Würth Elektronik		
		OO	Version 1
			09-12-01
Geprüft / checked	Kontrolliert / approved	Name	Änderung / modification
			Datum / date

Würth Elektronik eiSos GmbH & Co.KG

D-74638 Waldenburg · Max-Eyth-Straße 1 - 3 · Germany · Telefon (+49) (0) 7942 - 945 - 0 · Telefax (+49) (0) 7942 - 945 - 400
<http://www.we-online.com>

Spezifikation für Freigabe / specification for release

Kunde / customer : _____
 Artikelnummer / part number : **7447798180**
 Bezeichnung : **SPEICHERDROSSEL WE-PDF**
 description : **POWER-CHOKE WE-PDF**



DATUM / DATE : 2009-12-01

H Induktivitätskurve / Inductance curve :

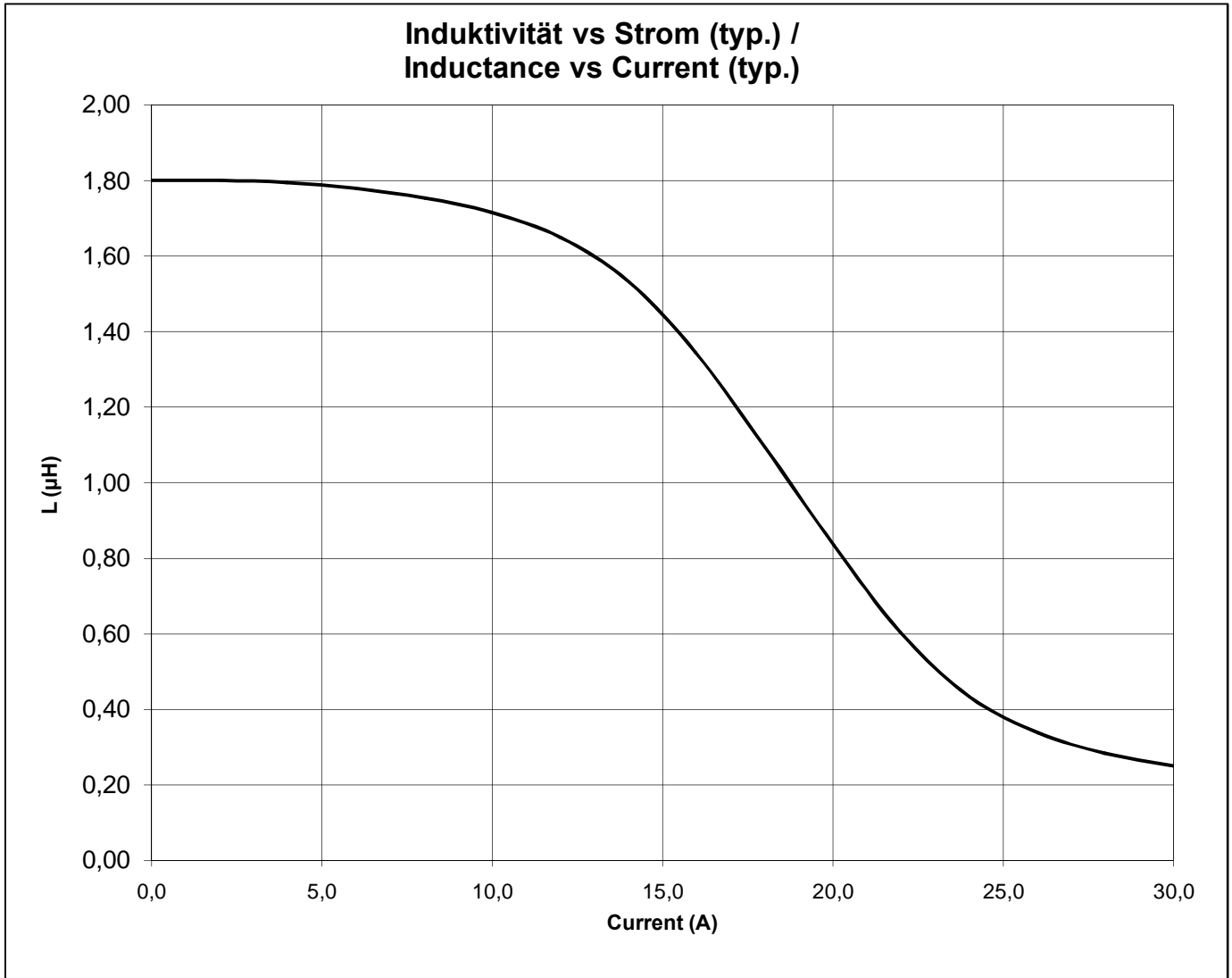

Freigabe erteilt / general release:	Kunde / customer			
.....			
Datum / date	Unterschrift / signature			
	Würth Elektronik			
.....	OO	Version 1	09-12-01
Geprüft / checked	Kontrolliert / approved	Name	Änderung / modification	Datum / date

Würth Elektronik eiSos GmbH & Co.KG

D-74638 Waldenburg · Max-Eyth-Straße 1 - 3 · Germany · Telefon (+49) (0) 7942 - 945 - 0 · Telefax (+49) (0) 7942 - 945 - 400
<http://www.we-online.com>

Spezifikation für Freigabe / specification for release

Kunde / customer : _____
 Artikelnummer / part number : **7447798180**
 Bezeichnung : **SPEICHERDROSSEL WE-PDF**
 description : **POWER-CHOKE WE-PDF**



DATUM / DATE : 2009-12-01

I Induktivitäts-Temperatur-Kurve / Inductance Temperature curve :

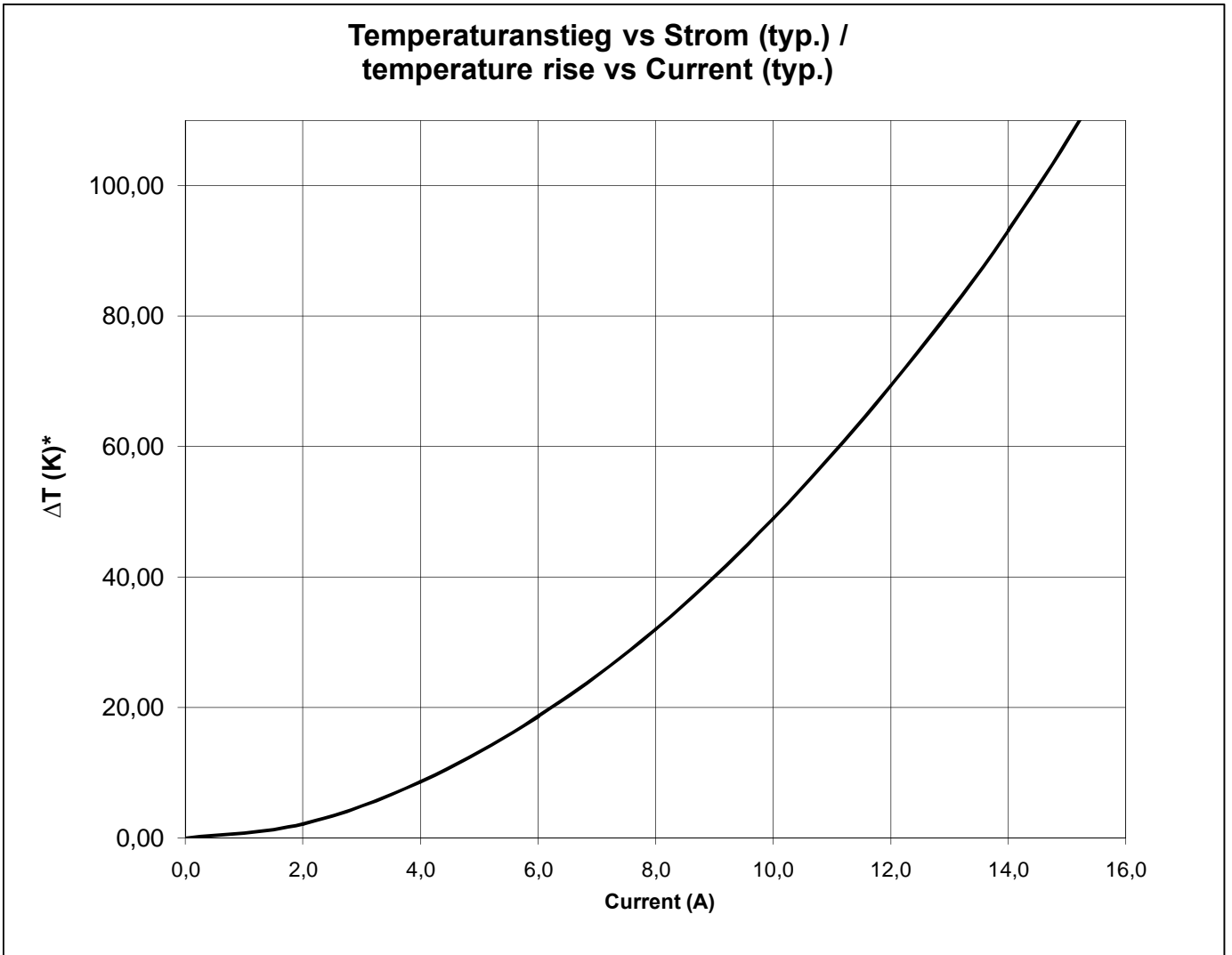

*Temperatur gemessen an Bauteiloberfläche / temperature measured at surface of component

Freigabe erteilt / general release:	Kunde / customer			
.....			
Datum / date	Unterschrift / signature			
	Würth Elektronik			
.....			
Geprüft / checked	Kontrolliert / approved	OO	Version 1	09-12-01
		Name	Änderung / modification	Datum / date

Würth Elektronik eiSos GmbH & Co.KG

D-74638 Waldenburg · Max-Eyth-Straße 1 - 3 · Germany · Telefon (+49) (0) 7942 - 945 - 0 · Telefax (+49) (0) 7942 - 945 - 400
<http://www.we-online.com>

Spezifikation für Freigabe / specification for release

Kunde / customer : _____
 Artikelnummer / part number : **7447798180**
 Bezeichnung : **SPEICHERDROSSEL WE-PDF**
 description : **POWER-CHOKE WE-PDF**



DATUM / DATE : 2009-12-01

K Rollenspezifikation / tape and reel specification :

Gurtspezifikation / Tape specification:

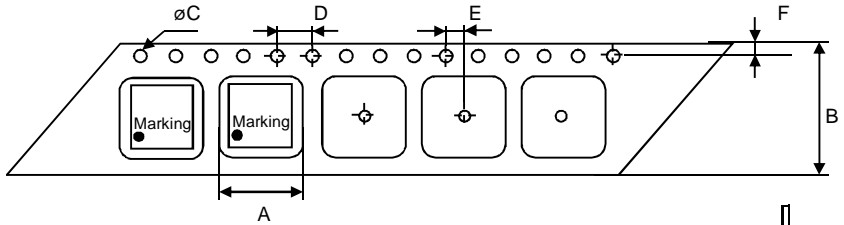

A	10,45 ± 0,1	mm
B	24,00 ± 0,3	mm
C	1,55 ± 0,05	mm
D	4,00 ± 0,1	mm
E	2,00 ± 0,1	mm
F	1,75 ± 0,1	mm
G	10,45 ± 0,1	mm
H	6,60 ± 0,1	mm

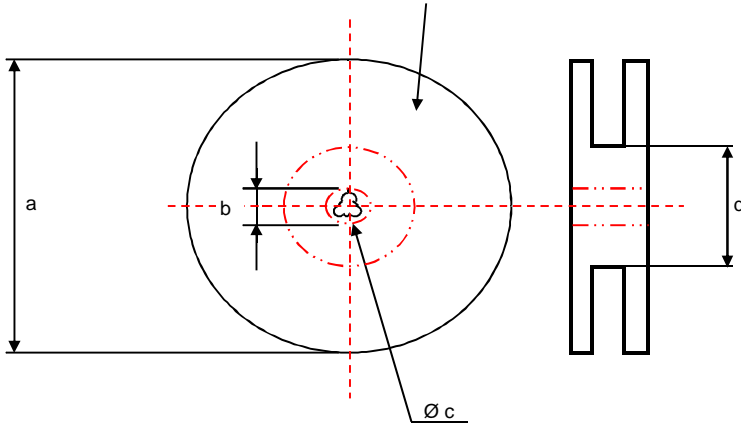
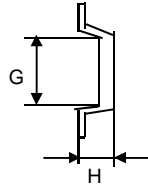

Rollenspezifikation / Reel specification:

a	330,0 ± 2,0	mm
b	21,00 ± 0,8	mm
c	13,00 ± 0,5	mm
d	100,0 ± 1,0	mm

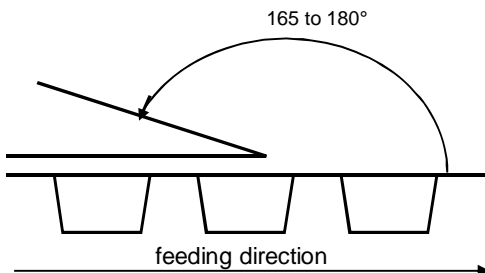

The force for tearing off cover tape is 10 to 130 grams in arrow direction

Freigabe erteilt / general release:	Kunde / customer			
		
Datum / date	Unterschrift / signature			
	Würth Elektronik			
.....	OO	Version 1	09-12-01
Geprüft / checked	Kontrolliert / approved	Name	Änderung / modification	Datum / date

This electronic component has been designed and developed for usage in general electronic equipment. Before incorporating this component into any equipment where higher safety and reliability is especially required or if there is the possibility of direct damage or injury to human body, for example in the range of aerospace, aviation, nuclear control, submarine, transportation, (automotive control, train control, ship control), transportation signal, disaster prevention, medical, public information network etc, Würth Elektronik eiSos GmbH must be informed before the design-in stage. In addition, sufficient reliability evaluation checks for safety must be performed on every electronic component which is used in electrical circuits that require high safety and reliability functions or performance.

Würth Elektronik eiSos GmbH & Co.KG

D-74638 Waldenburg · Max-Eyth-Straße 1 - 3 · Germany · Telefon (+49) (0) 7942 - 945 - 0 · Telefax (+49) (0) 7942 - 945 - 400
<http://www.we-online.com>