

GO 6 FAV M schwarz/black

Industrial Connectors:Rectangular connectors G-series:Cable plug

Delivery informations

Availability	available
Document created at	18.06.2008

Product description

Description	Surface mounted connector with flange with solder contacts
Type	GO 6 FAV M schwarz/black
Order No.	932 669-100
Type of contact	blade contacts
Number of contacts	6
Standard	DIN VDE 0627 / IEC 61984
Housing Color	black

Drawing

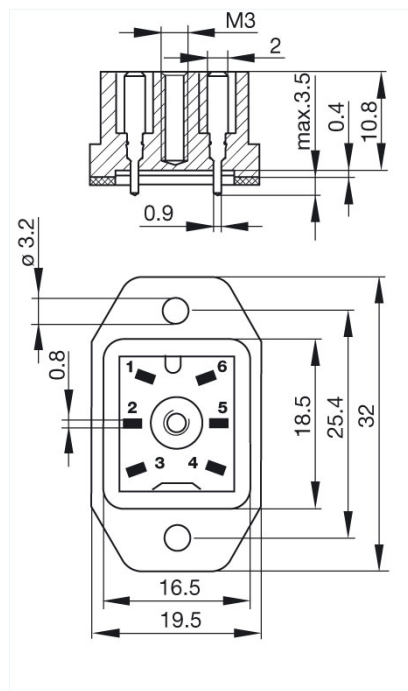

Technical data

Pin dimensions	2.8 mm x 0.8 mm
Rated voltage	AC/DC 50 V
Rated current	6 A
Contact resistance	≤ 4 mOhm
Type of termination	solder
Mounting	screws

Material

Contact surface material	Sn
Contact bearer material	PA
Housing material	PA
Environmental conditions	
Protection class (IEC 60529)	IP 65
Pollution severity	3
Temperature range	-40 °C to +90 °C
Inflammability class	
Housing	94 V-1
Contact bearer	94 V-1
Packing unit	
Packaging unit	100 pieces
Scope of delivery and accessories	
Scope of delivery	1 surface mounted connector, 1 flat gasket
Accessories to order separately	can be plugged into GO 6 WFSchwarz/black