

SD3443/5443

Silicon Phototransistor

SWITCHING TIME TEST CIRCUIT

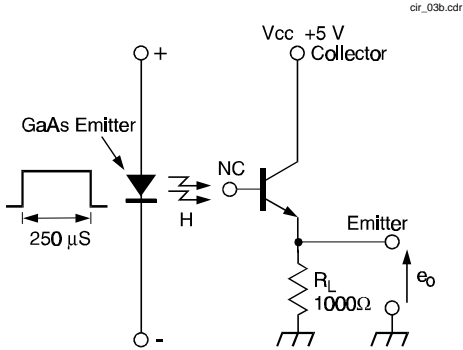

Fig. 1 Responsivity vs Angular Displacement (SD3443) gra_052.ds4

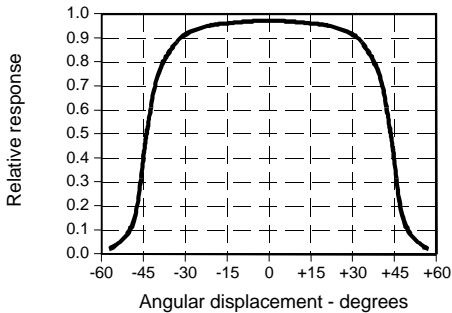

Fig. 2 Responsivity vs Angular Displacement (SD5443) gra_053.ds4

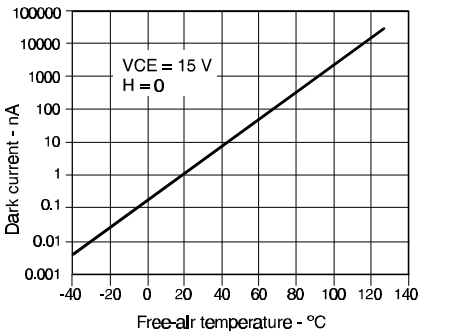

Fig. 3 Dark Current vs Temperature gra_303.cdr



SWITCHING WAVEFORM

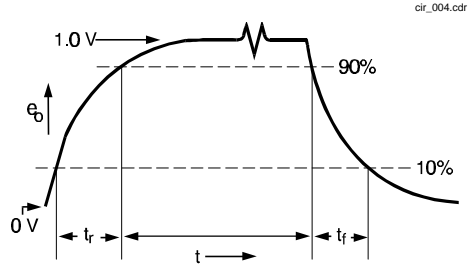

Fig. 4 Non-Saturated Switching Time vs Load Resistance gra_041.ds4

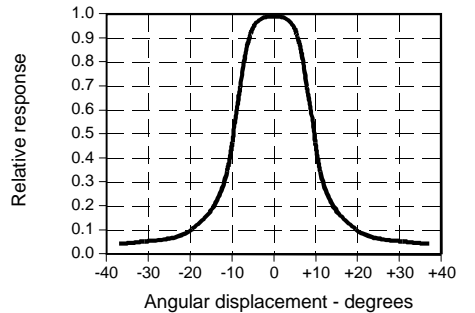
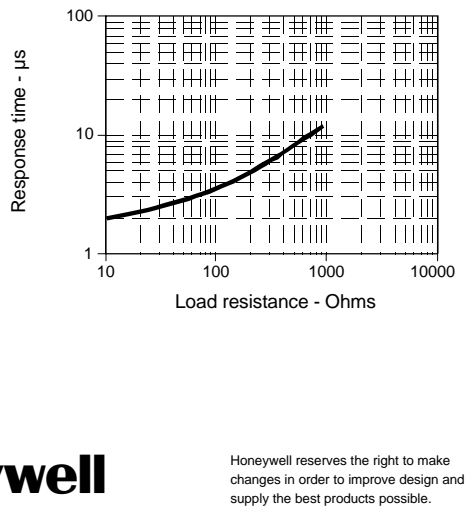

Fig. 5 Dark Current vs Temperature gra_303.cdr



SD3443/5443

Silicon Phototransistor

Fig. 5 Spectral Response

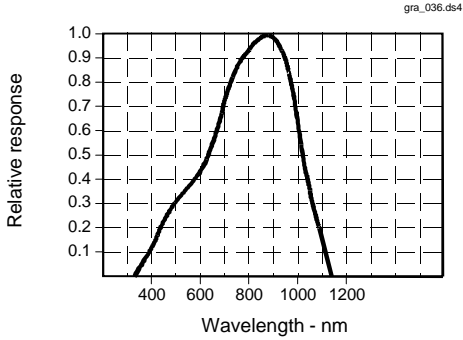

Fig. 6 Coupling Characteristics
SE3450 with SD3443

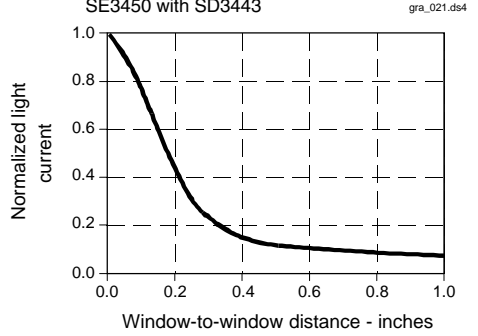

Fig. 7 Coupling Characteristics
SE5450 with SD5443

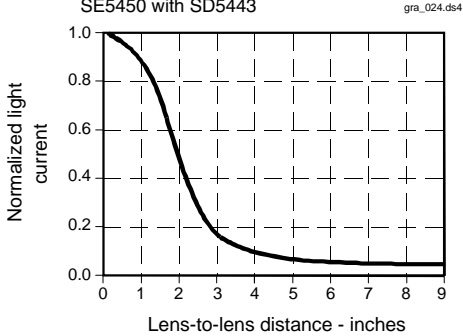
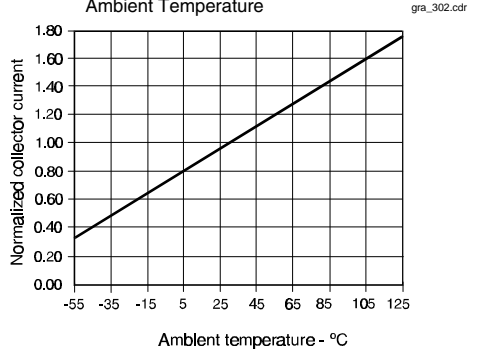

Fig. 8 Collector Current vs
Ambient Temperature



All Performance Curves Show Typical Values