

Ausführung EM/ET 239 F

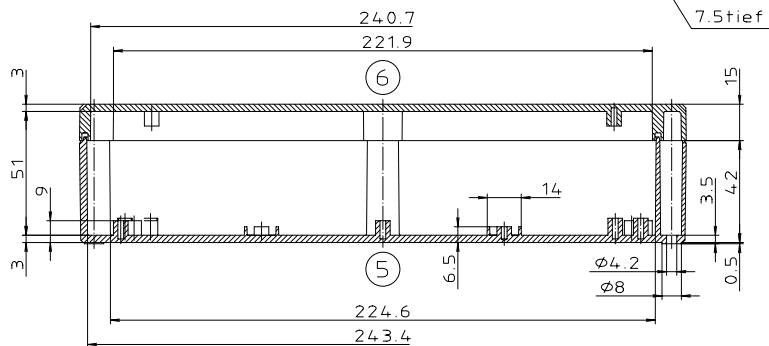

Ausführung EM/ET 239 -LP

"Schutzvermerk nach DIN 31-Beachten"

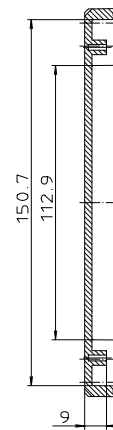
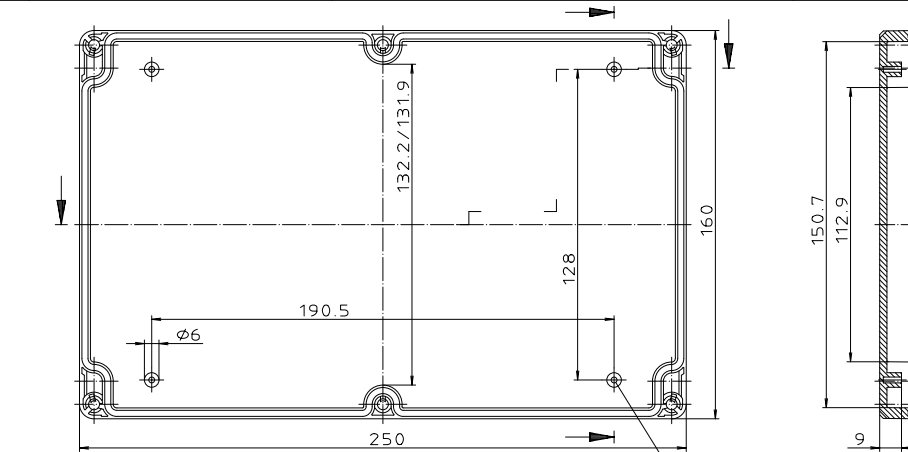
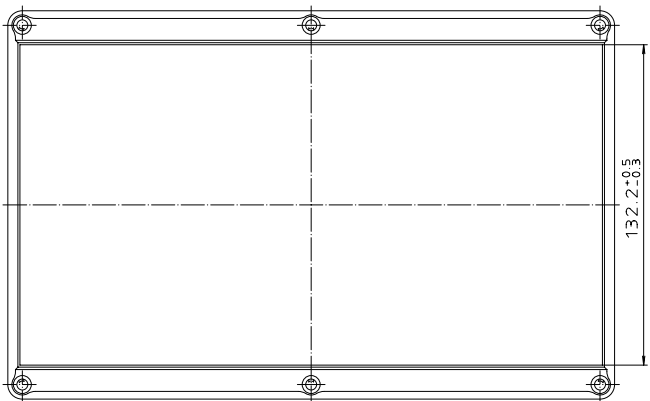
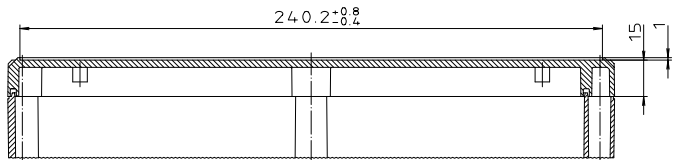
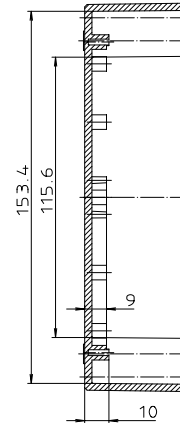
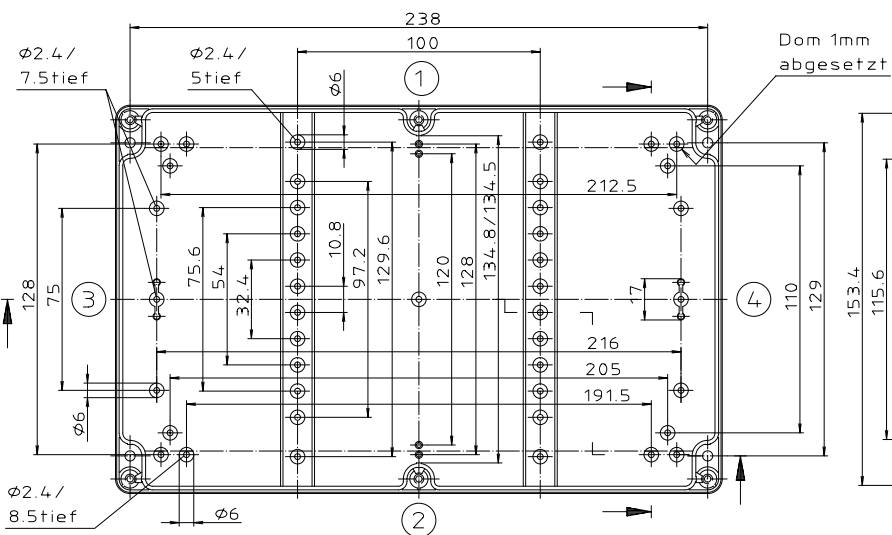
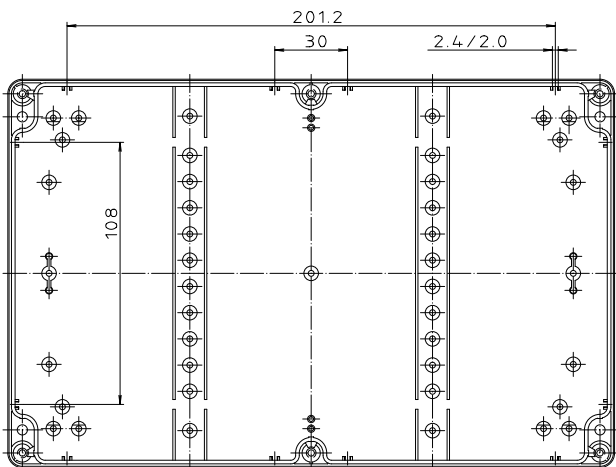

Maßstab: 1:1	
Zchn.Nr: 1K 5145.122.02	
Artikel: EM/ET 239(-LP) EM/ET 239 F(-LP) Katalogzeichnung	
3033	DISK: 2 501 037
22.08.2002	Datum: 05.08.93 AK



A Phoenix Contact Company