

Agilent HSMx-C110/C170/C190/C191/C150 High Performance ChipLED

Data Sheet

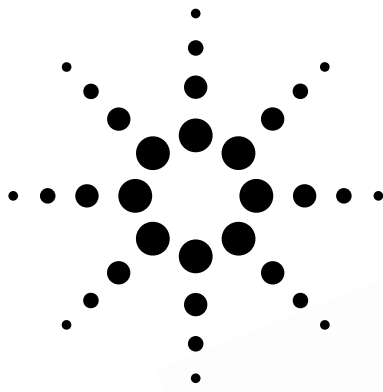

HSMA-C110/C170/C190/C191/C150 **HSML-C110/C170/C190/C191/C150** **HSMC-C110/C170/C190/C191/C150** **HSMZ-C110/C170/C190**

Description

These chip-type LEDs utilize Aluminum Indium Gallium Phosphide (AlInGaP) material technology. The AlInGaP material has a very high luminous efficiency, capable of producing high light output over a wide range of drive currents. The available colors in this surface mount series are 592 nm Amber, 605 nm Orange, 626 nm Red for AS AlInGaP and 631 nm red for TS AlInGaP.

All packages are binned by both color and intensity, except for red color.

These ChipLEDs come either in two top emitting packages (HSMx-C170/C190/C191/C150) or in a side emitting package (HSMx-C110). The right angle ChipLEDs are suitable for applications such as LCD backlighting. The top emitting ChipLEDs with wide viewing angle are suitable for light piping and direct backlighting of keypads and panels. In order to facilitate pick and place operation, these ChipLEDs are shipped in tape and reel, with 4000 units per reel for HSMx-C170/C190/C191 and 3000 units per reel for HSMx-C110/C150.

These packages are compatible with IR soldering process.

Features

- High brightness AlInGaP material
- Small size
- Industry standard footprint
- Diffused optics
- Top emitting or right angle emitting
- Available in 3 colors (red, orange, amber)
- Compatible with IR soldering
- Available in 8 mm tape on 7" diameter reel
- Reel sealed in zip locked moisture barrier bags

Applications

- LCD backlighting
- Push button backlighting
- Front panel indicator
- Symbol indicator
- Microdisplays
- Small message panel signage



Package Dimensions

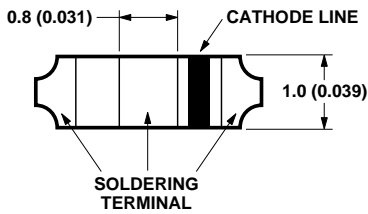
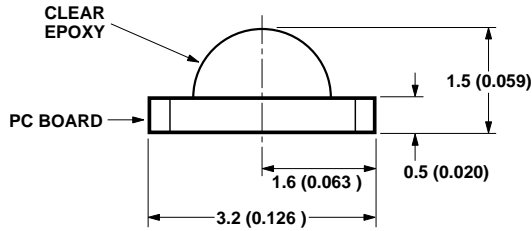
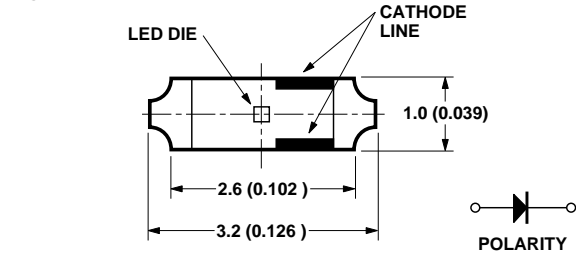

HSMx-C110

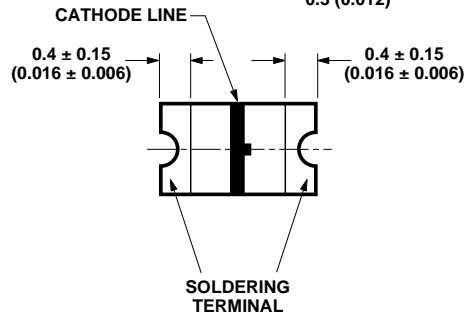
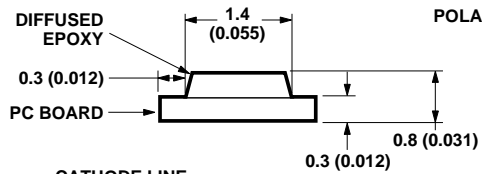
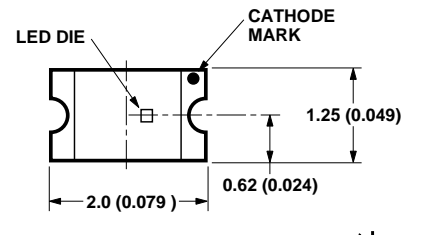

HSMx-C170

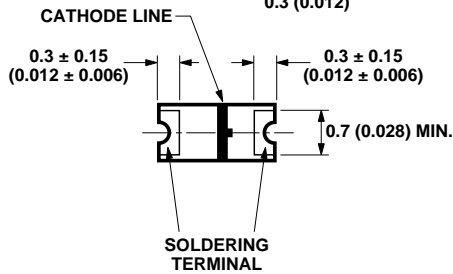
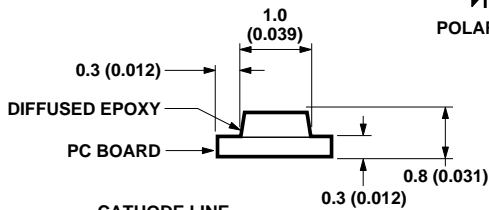
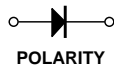
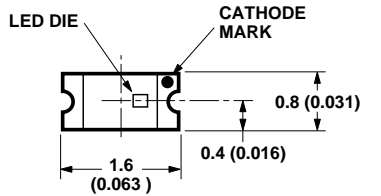

HSMx-C190

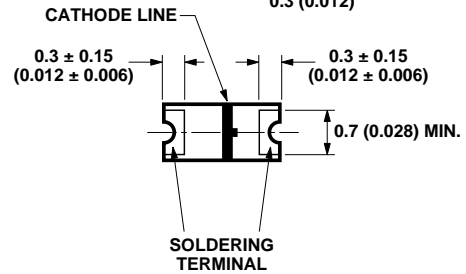
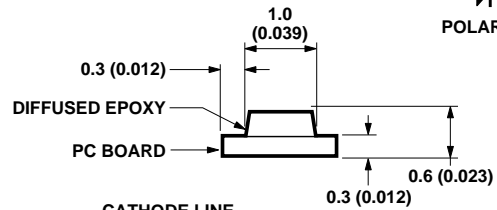
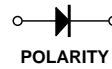
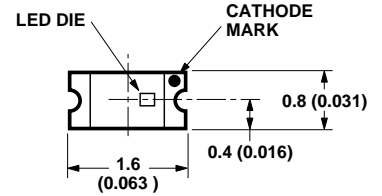

HSMx-C191

- NOTES:
 1. ALL DIMENSIONS IN MILLIMETERS (INCHES).
 2. TOLERANCE IS ± 0.1 mm (± 0.004 IN.) UNLESS OTHERWISE SPECIFIED.

Package Dimensions, continued

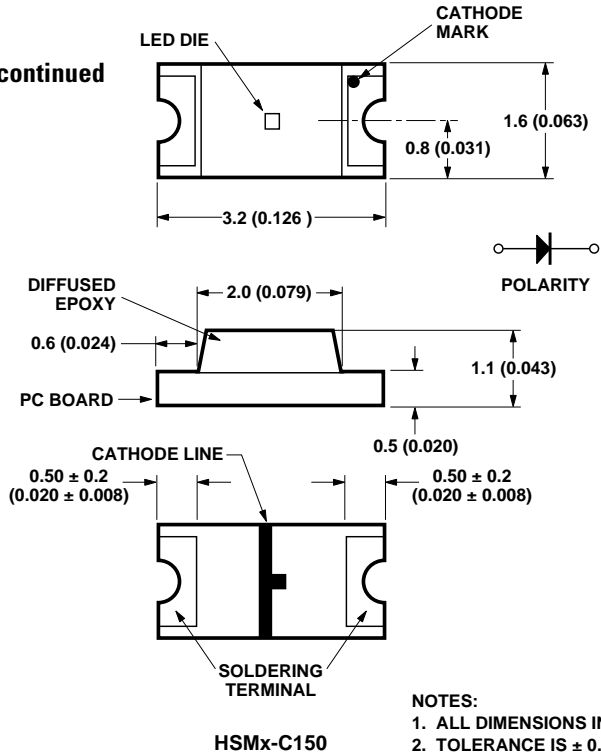

Device Selection Guide

| Footprint (mm) ^[1,2] | AS AlInGaP Amber | AS AlInGaP Orange | AS AlInGaP Red | TS AlInGaP Red | Package Description |
|---------------------------------|------------------|-------------------|----------------|----------------|-----------------------|
| 1.6 x 0.8 x 0.8 | HSMA-C190 | HSML-C190 | HSMC-C190 | HSMZ-C190 | Untinted, Diffused |
| 2.0 x 1.25 x 0.8 | HSMA-C170 | HSML-C170 | HSMC-C170 | HSMZ-C170 | Untinted, Diffused |
| 3.2 x 1.0 x 1.5 | HSMA-C110 | HSML-C110 | HSMC-C110 | HSMZ-C110 | Untinted, Nondiffused |
| 1.6 x 0.8 x 0.6 | HSMA-C191 | HSML-C191 | HSMC-C191 | | Untinted, Diffused |
| 3.2 x 1.6 x 1.1 | HSMA-C150 | HSML-C150 | HSMC-C150 | | Untinted, Diffused |

Notes:

1. Dimensions in mm.
2. Tolerance ± 0.1 mm unless otherwise noted.

Absolute Maximum Ratings

$T_A = 25^\circ\text{C}$

| Parameter | HSMA-C110/170/190/191/150 HSML-C110/170/190/191/150 HSMC-C110/170/190/191/150 | HSMZ-C110/170/190 | Units |
|---|---|-------------------|------------------|
| DC Forward Current ^[1,2] | 25 | 25 | mA |
| Power Dissipation | 60 | 65 | mW |
| Reverse Voltage ($I_R = 100 \mu\text{A}$) | 5 | 5 | V |
| LED Junction Temperature | 95 | 95 | $^\circ\text{C}$ |
| Operating Temperature Range | -30 to +85 | -30 to +85 | $^\circ\text{C}$ |
| Storage Temperature Range | -40 to +85 | -40 to +85 | $^\circ\text{C}$ |
| Soldering Temperature | See reflow soldering profile (Figure 7 & 8) | | |

Notes:

1. Derate linearly as shown in Figure 4.
2. Drive currents above 5 mA are recommended for best long term performance.

Electrical Characteristics

T_A = 25°C

| Parameter Number | Forward Voltage V _F (Volts) @ I _F = 20 mA | | Reverse Breakdown V _R (Volts) @ I _R = 100 μA | Capacitance C (pF), V _F = 0, f = 1 MHz | Thermal Resistance R _{θJ-PIN} (= °C/W) |
|-----------------------|---|------|--|---|---|
| | Typ. | Max. | Min. | Typ. | Typ. |
| HSMA-C110 | 1.9 | 2.4 | 5 | 45 | 600 |
| HSML-C110 | 1.9 | 2.4 | 5 | 45 | 600 |
| HSMC-C110 | 1.9 | 2.4 | 5 | 45 | 600 |
| HSMZ-C110 | 2.2 | 2.6 | 5 | 35 | 600 |
| HSMA-C170/190/191/150 | 1.9 | 2.4 | 5 | 45 | 300 |
| HSML-C170/190/191/150 | 1.9 | 2.4 | 5 | 45 | 300 |
| HSMC-C170/190/191/150 | 1.9 | 2.4 | 5 | 45 | 300 |
| HSMZ-C170/190 | 2.2 | 2.6 | 5 | 35 | 300 |

Optical Characteristics

T_A = 25°C

| Part Number | Color | Luminous Intensity I _v (mcd) @ 20 mA ^[1] | | Peak Wavelength λ _{peak} (nm) | Color, Dominant Wavelength λ _d ^[2] (nm) | Viewing Angle 2 θ _{1/2} Degrees ^[3] | Luminous Efficacy η _v (lm/w) |
|-----------------------|-----------|---|------|--|--|--|--|
| | | Min. | Typ. | Typ. | Typ. | Typ. | Typ. |
| HSMA-C110 | AS Amber | 28.5 | 95 | 595 | 592 | 130 | 480 |
| HSMA-C170/190/191/150 | AS Amber | 28.5 | 90 | 595 | 592 | 170 | 480 |
| HSML-C110 | AS Orange | 28.5 | 95 | 609 | 605 | 130 | 370 |
| HSML-C170/190/191/150 | AS Orange | 28.5 | 90 | 609 | 605 | 170 | 370 |
| HSMC-C110 | AS Red | 28.5 | 95 | 637 | 626 | 130 | 155 |
| HSMC-C170/190/191/150 | AS Red | 28.5 | 90 | 637 | 626 | 170 | 155 |
| HSMZ-C110 | TS Red | 45 | 170 | 643 | 631 | 130 | 122 |
| HSMZ-C170/190 | TS Red | 45 | 165 | 643 | 631 | 170 | 122 |

Notes:

1. The luminous intensity, I_v, is measured at the peak of the spatial radiation pattern which may not be aligned with the mechanical axis of the lamp package.
2. The dominant wavelength, λ_d, is derived from the CIE Chromaticity Diagram and represents the perceived color of the device.
3. θ_{1/2} is the off-axis angle where the luminous intensity is 1/2 the peak intensity.

Color Bin Limits^[1]

| Orange Color Bins^[1] | | |
|--|-------------|-------------|
| Dom. Wavelength (nm) | | |
| Bin ID | Min. | Max. |
| A | 597.0 | 600.0 |
| B | 600.0 | 603.0 |
| C | 603.0 | 606.0 |
| D | 606.0 | 609.0 |
| E | 609.0 | 612.0 |
| F | 612.0 | 615.0 |

Tolerance: ± 1 nm.

| Yellow/Amber Color Bins^[1] | | |
|--|-------------|-------------|
| Dom. Wavelength (nm) | | |
| Bin ID | Min. | Max. |
| A | 582.0 | 584.5 |
| B | 584.5 | 587.0 |
| C | 587.0 | 589.5 |
| D | 589.5 | 592.0 |
| E | 592.0 | 594.5 |
| F | 594.5 | 597.0 |

Tolerance: ± 0.5 nm.

Note:

1. Bin categories are established for classification of products. Products may not be available in all categories. Please contact your Agilent representative for information on currently available bins.

Light Intensity (Iv) Bin Limits^[1]

| Intensity (mcd) | | | Intensity (mcd) | | |
|------------------------|-------------|-------------|------------------------|-------------|-------------|
| Bin ID | Min. | Max. | Bin ID | Min. | Max. |
| A | 0.11 | 0.18 | N | 28.50 | 45.00 |
| B | 0.18 | 0.29 | P | 45.00 | 71.50 |
| C | 0.29 | 0.45 | Q | 71.50 | 112.50 |
| D | 0.45 | 0.72 | R | 112.50 | 180.00 |
| E | 0.72 | 1.10 | S | 180.00 | 285.00 |
| F | 1.10 | 1.80 | T | 285.00 | 450.00 |
| G | 1.80 | 2.80 | U | 450.00 | 715.00 |
| H | 2.80 | 4.50 | V | 715.00 | 1125.00 |
| J | 4.50 | 7.20 | W | 1125.00 | 1800.00 |
| K | 7.20 | 11.20 | X | 1800.00 | 2850.00 |
| L | 11.20 | 18.00 | Y | 2850.00 | 4500.00 |
| M | 18.00 | 28.50 | | | |

Tolerance: $\pm 15\%$.

Note:

1. Bin categories are established for classification of products. Products may not be available in all categories. Please contact your Agilent representative for information on currently available bins.

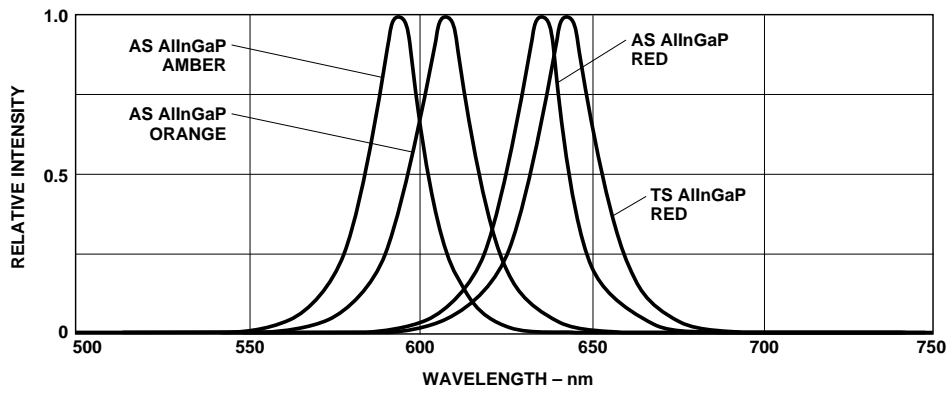

Figure 1. Relative intensity vs. wavelength.

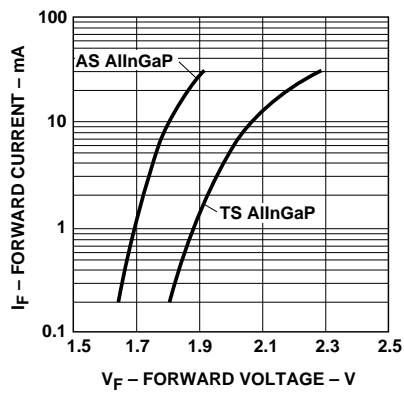

Figure 2. Forward current vs. forward voltage.

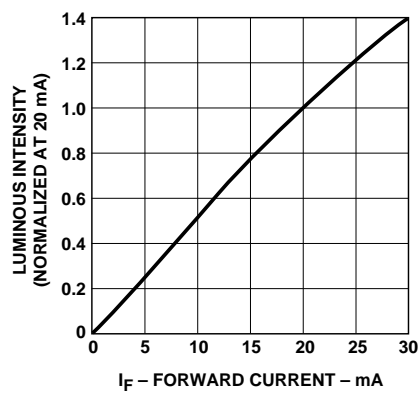

Figure 3. Luminous intensity vs. forward current.

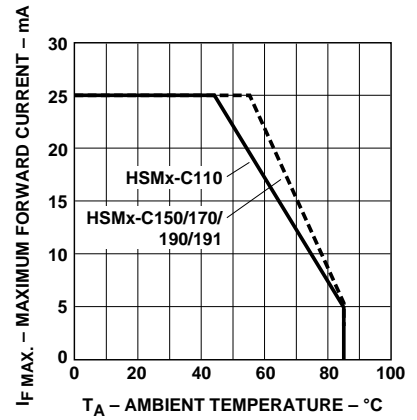

Figure 4. Maximum forward current vs. ambient temperature.

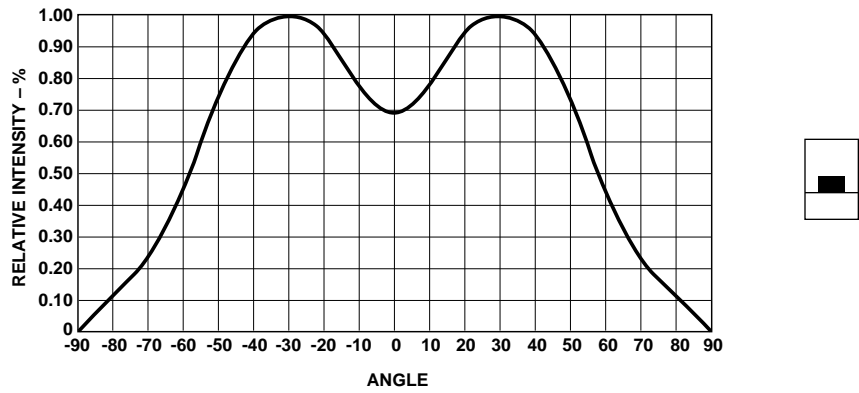
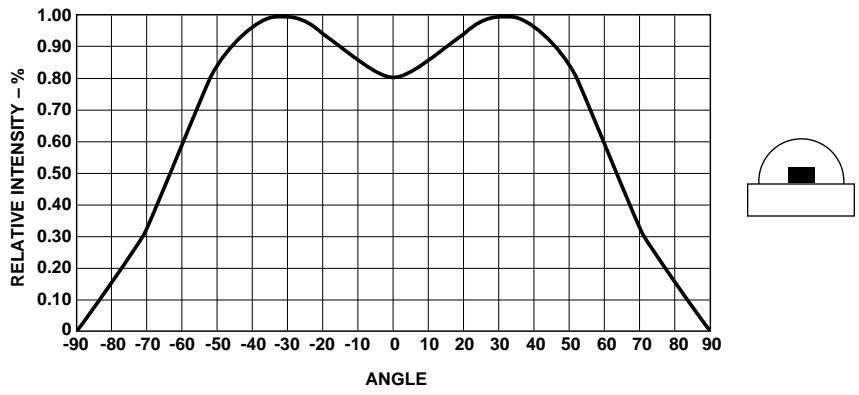

Figure 5. Relative intensity vs. angle for HSMx-C110.

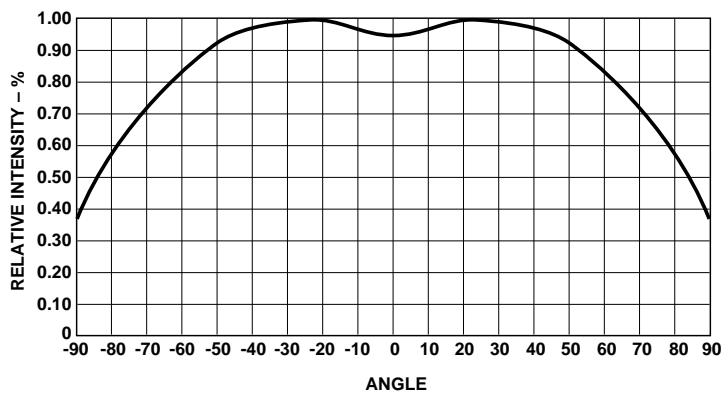

Figure 6. Relative intensity vs. angle for HSMx-C170, C190, C191, and C150.

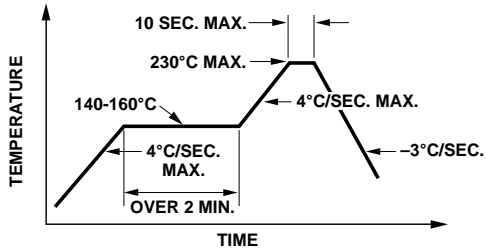
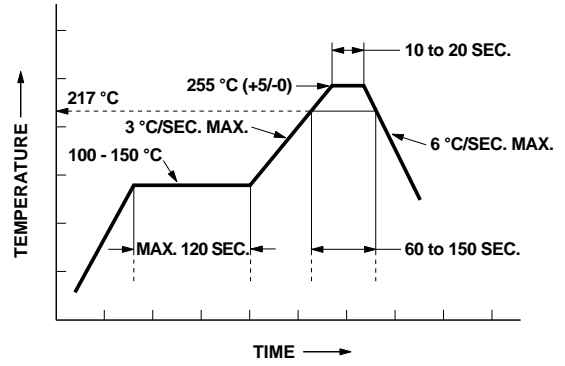

Figure 7. Recommended reflow soldering profile.



* THE TIME FROM 25 °C TO PEAK TEMPERATURE = 6 MINUTES MAX.

Figure 8. Recommended Pb-free reflow soldering profile.

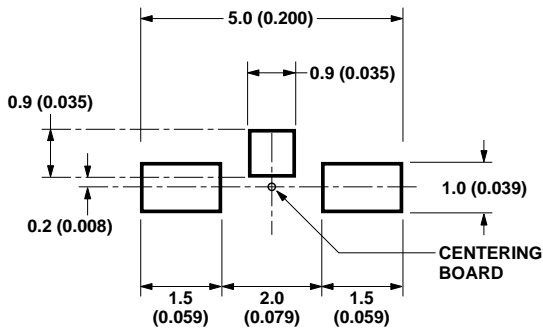

Figure 9. Recommended soldering pattern for HSMx-C110.

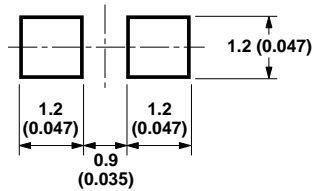

Figure 10. Recommended soldering pattern for HSMx-C170.

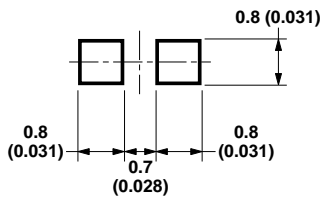

Figure 11. Recommended soldering pattern for HSMx-C190 and C191.

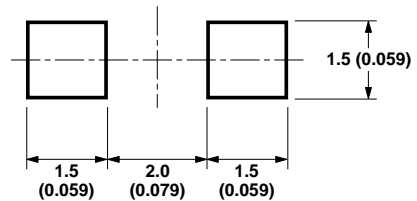

Figure 12. Recommended soldering pattern for HSMx-C150.

Note: All dimensions in millimeters (inches).

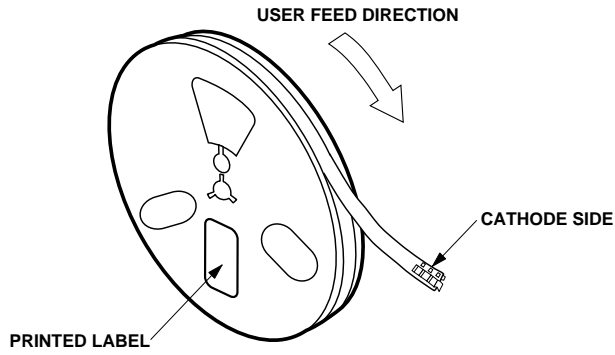

Figure 13. Reeling orientation.

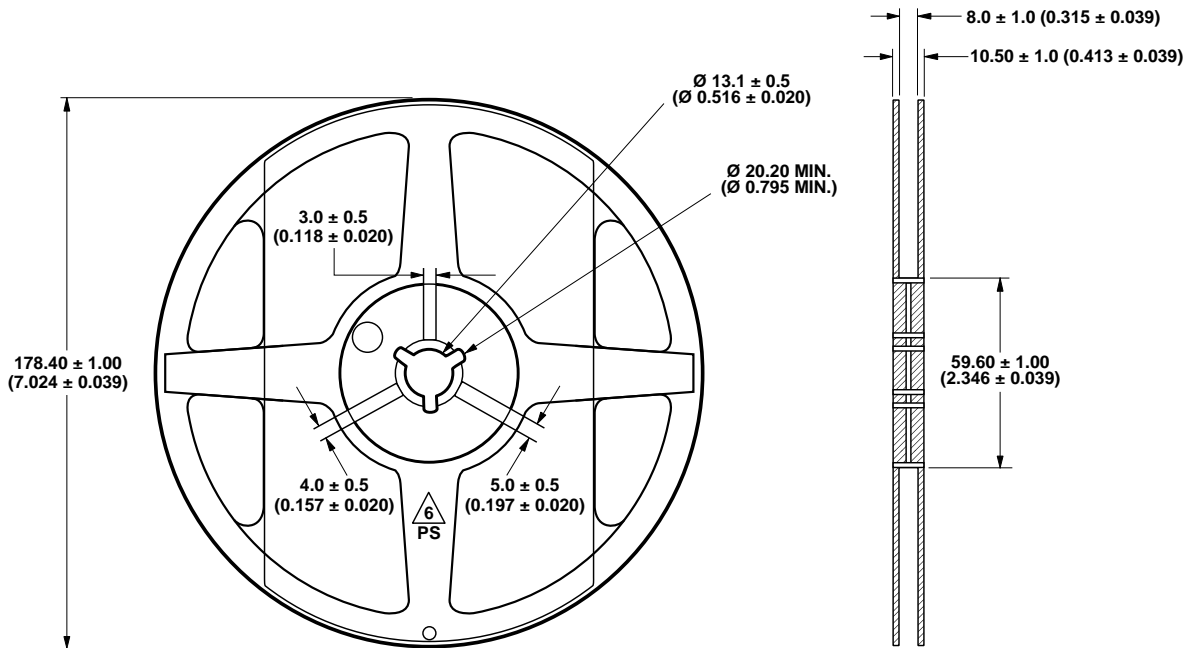

Figure 14. Reel dimensions.

Note: All dimensions in millimeters (inches).

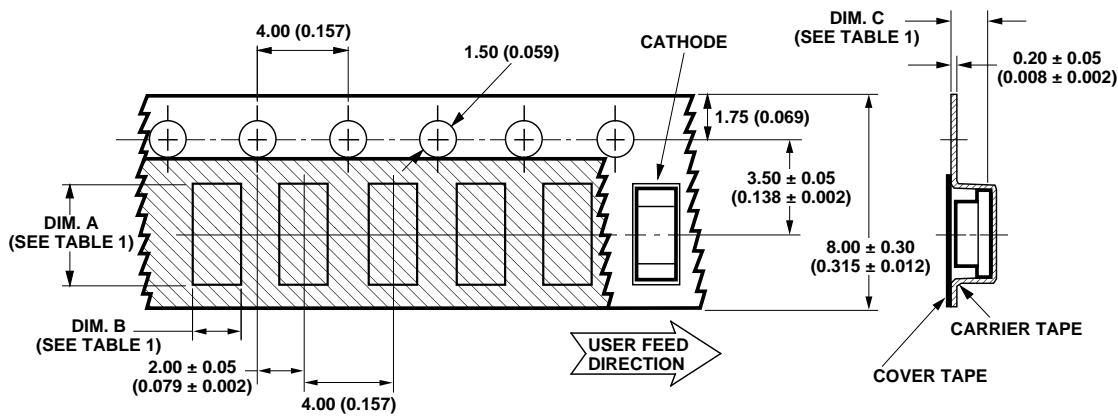

TABLE 1
DIMENSIONS IN MILLIMETERS (INCHES)

| PART NUMBER | DIM. A ± 0.10 (± 0.004) | DIM. B ± 0.10 (± 0.004) | DIM. C ± 0.10 (± 0.004) |
|------------------|----------------------------|----------------------------|----------------------------|
| HSMx-C191 SERIES | 1.86 (0.073) | 0.89 (0.035) | 0.87 (0.034) |
| HSMx-C190 SERIES | 1.80 (0.071) | 0.95 (0.037) | 0.87 (0.034) |
| HSMx-C170 SERIES | 2.30 (0.091) | 1.45 (0.057) | 0.95 (0.037) |
| HSMx-C110 SERIES | 3.40 (0.134) | 1.70 (0.067) | 1.20 (0.047) |
| HSMx-C150 SERIES | 3.50 (0.138) | 1.88 (0.074) | 1.27 (0.050) |

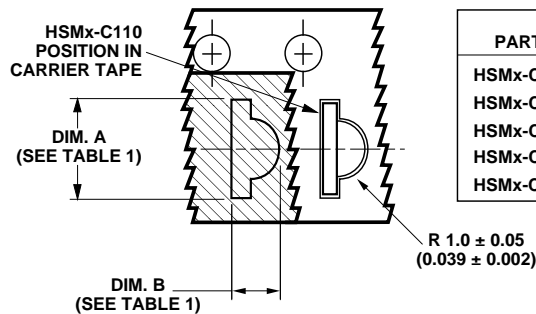

Figure 15. Tape dimensions.

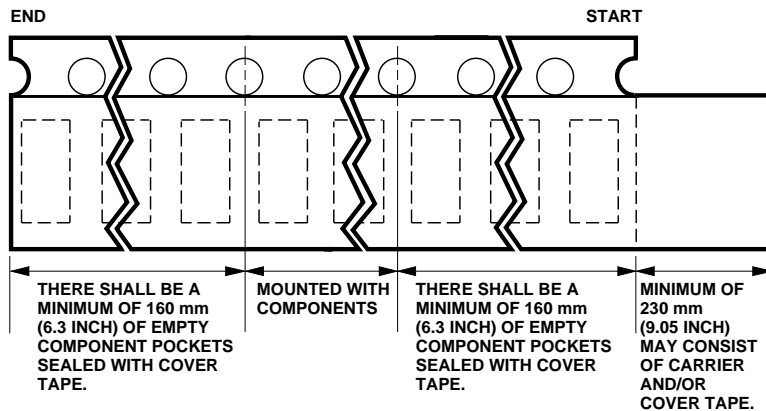

Figure 16. Tape leader and trailer dimensions.

NOTES:

1. ALL DIMENSIONS IN MILLIMETERS (INCHES).
2. TOLERANCE IS ± 0.1 mm (± 0.004 IN.) UNLESS OTHERWISE SPECIFIED.

Convective IR Reflow Soldering

For more information on IR reflow soldering, refer to Application Note 1060, *Surface Mounting SMT LED Indicator Components*.

Storage Condition: 5 to 30°C @ 60% RH max.

Baking is required under the condition:

- a) the blue silica gel indicator becoming white/transparent color
- b) the pack has been opened for more than 1 week

Baking recommended condition: 60 +/- 5°C for 20 hours.

www.agilent.com/semiconductors

For product information and a complete list of distributors, please go to our web site.

For technical assistance call:

Americas/Canada: +1 (800) 235-0312 or
(916) 788-6763

Europe: +49 (0) 6441 92460

China: 10800 650 0017

Hong Kong: (+65) 6756 2394

India, Australia, New Zealand: (+65) 6755 1939

Japan: (+81 3) 3335-8152 (Domestic/International), or 0120-61-1280 (Domestic Only)

Korea: (+65) 6755 1989

Singapore, Malaysia, Vietnam, Thailand,
Philippines, Indonesia: (+65) 6755 2044

Taiwan: (+65) 6755 1843

Data subject to change.

Copyright © 2004 Agilent Technologies, Inc.

Obsoletes 5988-5891EN

April 23, 2004

5989-0519EN



Agilent Technologies