

Part Number: SA10-21SRWA SUPER BRIGHT RED

Features

- 1.0 INCH DIGIT HEIGHT.
- LOW CURRENT OPERATION.
- EXCELLENT CHARACTER APPEARANCE.
- HIGH LIGHT OUTPUT.
- EASY MOUNTING ON P.C. BOARDS OR SOCKETS.
- I.C. COMPATIBLE.
- MECHANICALLY RUGGED.
- STANDARD : GRAY FACE, WHITE SEGMENT.
- RoHS COMPLIANT.

Description

The Super Bright Red source color devices are made with Gallium Aluminum Arsenide Red Light Emitting Diode.

Package Dimensions & Internal Circuit Diagram

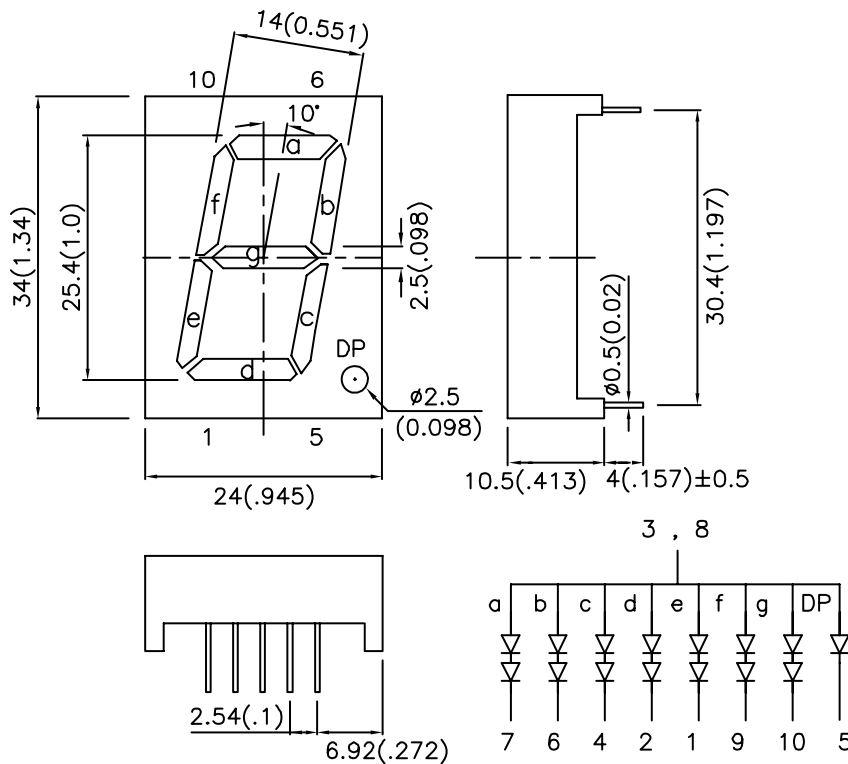

Notes:

1. All dimensions are in millimeters (inches), Tolerance is $\pm 0.25(0.01)$ unless otherwise noted.
2. Specifications are subject to change without notice.

Selection Guide

Part No.	Dice	Lens Type	Iv (ucd) [1] @ 10mA		Description
			Min.	Typ.	
SA10-21SRWA	SUPER BRIGHT RED (GaAlAs)	WHITE DIFFUSED	12000	60000	Common Anode, Rt. Hand Decimal.

Note:

1. Luminous Intensity/ Luminous Flux: +/-15%.

Electrical / Optical Characteristics at TA=25°C

Symbol	Parameter	Device	Typ.	Max.	Units	Test Conditions
λ_{peak}	Peak Wavelength	Super Bright Red	660		nm	IF=20mA
λ_D [1]	Dominant Wavelength	Super Bright Red	640		nm	IF=20mA
$\Delta\lambda_{1/2}$	Spectral Line Half-width	Super Bright Red	20		nm	IF=20mA
C	Capacitance	Super Bright Red	45		pF	VF=0V;f=1MHz
VF [2]	Forward Voltage Per Segment or(DP)	Super Bright Red	3.7 (1.85)	5.0 (2.5)	V	IF=20mA
IR	Reverse Current Per Segment or(DP)	Super Bright Red		10 (10)	uA	VR = 10V(5V)

Notes:

1. Wavelength: +/-1nm
2. Forward Voltage: +/-0.1V

Absolute Maximum Ratings at TA=25°C

Parameter	Super Bright Red	Units
Power dissipation Per Segment or(DP)	150 (100)	mW
DC Forward Current Per Segment or(DP)	30 (30)	mA
Peak Forward Current [1] Per Segment or(DP)	155 (155)	mA
Reverse Voltage Per Segment or(DP)	10 (5)	V
Operating/Storage Temperature	-40°C To +85°C	
Lead Solder Temperature [2]	260°C For 3 Seconds	

Notes:

1. 1/10 Duty Cycle, 0.1ms Pulse Width.
2. 2mm below package base.

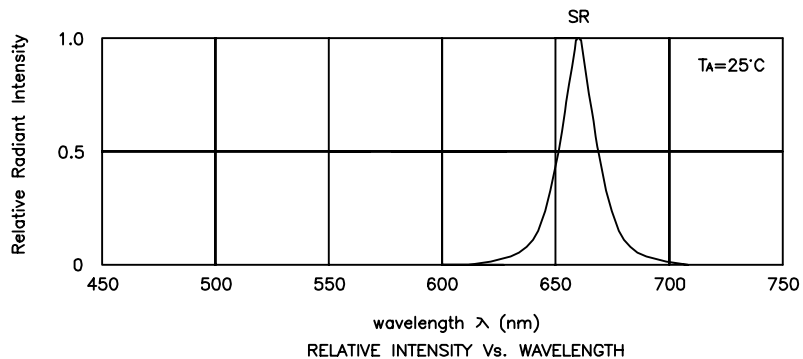

Super Bright Red

SA10-21SRWA

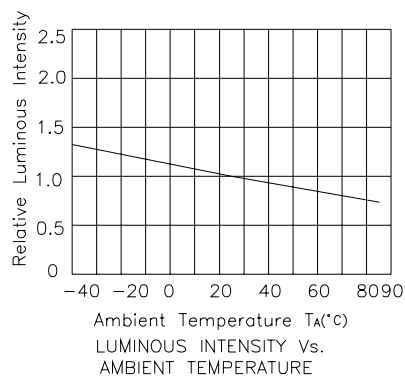
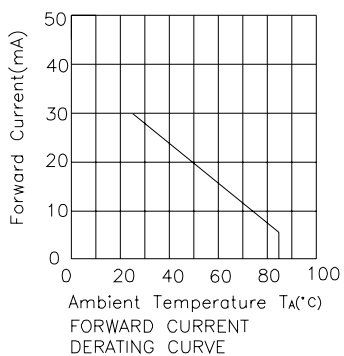
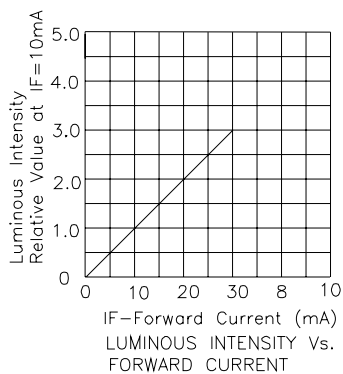
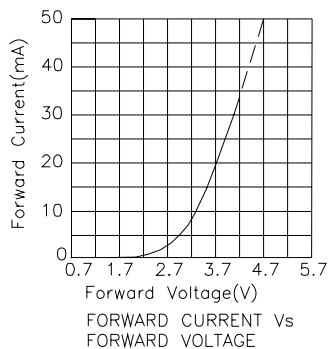

PACKING & LABEL SPECIFICATIONS

SA10-21SRWA

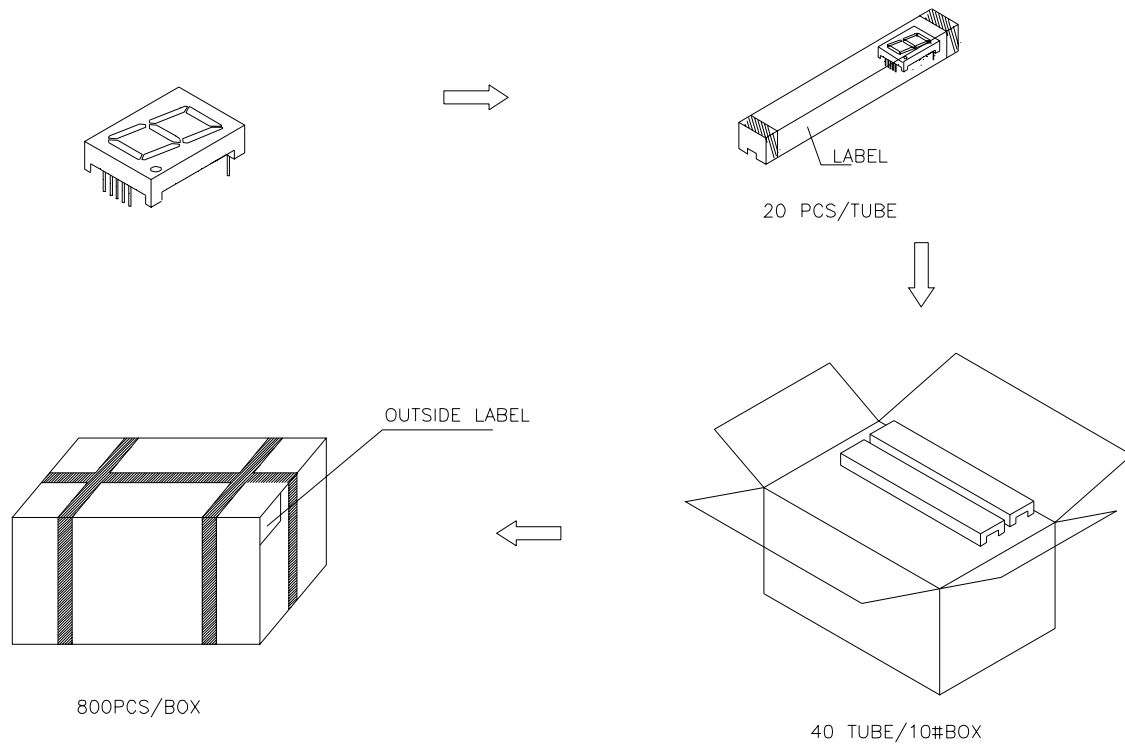

Inside LABEL Paste On The IC-tube

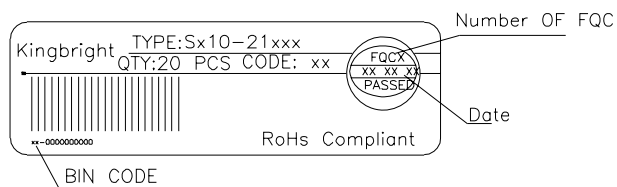

Outside LABEL Paste On The Box

