

The information disclosed herein was originated by and is the property of MAZeT. MAZeT reserves all patent, proprietary, design, use, sales, manufacturing and reproduction rights thereto. Product names used in this publication are for identification purposes only and may be trademark of their respective companies.



## DATA-SHEET

# MCS3AS

### 3-element colour sensor – SMD/SO8

#### Table of Contents

1. FUNCTION .....	2
2. APPLICATION .....	2
3. FEATURES .....	2
4. CONSTRUCTION .....	2
5. MAXIMUM RATINGS / CHARACTERISTICS .....	3
6. CHARACTERISTIC CURVES.....	4
7. PACKAGE OVERVIEW .....	5
8. PIN-CONFIGURATION.....	6
9. APPLICATION CIRCUIT .....	6
10. APPLICATION NOTE.....	6
11. ORDERING INFORMATION .....	7

**MAZeT GmbH**

Page 1 of 7

REV.	DESCRIPTION	APPROVED
1	V1.17	2006-03-01

## 1. FUNCTION

The colour sensors are made of 3 Si-PIN photo diodes integrated on chip. They are carried out as segments of a ring with the diameter of 2,0 mm. The design as Si-PIN photo diodes allows signal frequencies up to MHz-range. In order to achieve a small cross talk between the photodiodes the individual sectors have been separated from each other by additional structures. Each of these photodiodes is sensitized with dielectric spectral filter for its colour range, preferably for the primary colours red, green and blue.

## 2. APPLICATION

- Quality control
- Monitoring the production
- Control of manufacturing
- Detection of colour marks

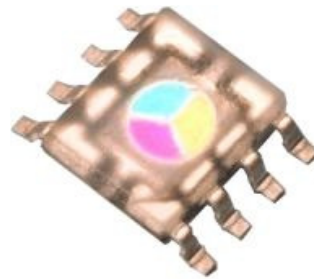

## 3. FEATURES

Dielectric filters guarantee the good optical properties of the colour sensors, such as:

- high transmission
- slight aging of the filter
- high temperature stability
- high signal frequency
- reduced cross talk
- small size (diameter of the optical sensitive surface ca. 2 mm)

## 4. CONSTRUCTION

- 3 on chip integrated PIN photo diodes
- dielectric filters for the three colour ranges: red, green and blue
- package design SOP8
- Electrical connections
  - three anodes
  - one separated diode for minimization of the cross-talk
  - one common cathode

REV.	DESCRIPTION	APPROVED
1	V1.17	2006-03-01

## 5. MAXIMUM RATINGS / CHARACTERISTICS

(TA = 25°C; per single diode)

Description	Symbol	Condition	typ. Value	Unit
Diameter of the light sensitivity area	D		2,0	mm
Light sensitivity area per element	A		0,85	mm <sup>2</sup>
Photo sensitivity of the colour ranges	S <sub>max</sub>	$\lambda_B = 470 \text{ nm}$ $\lambda_G = 570 \text{ nm}$ $\lambda_R = 650 \text{ nm}$	0,26 0,33 0,41	A/W
Field of the spectral sensitivity $\pm 2\%*\lambda$	$\lambda_B$ $\lambda_G$ $\lambda_R$		400 - 510 490 - 610 590 - 750	nm
Rise and fall time of the photo-current	t <sub>r</sub> , t <sub>f</sub>		<1	μs
Noise equivalent power	NEP	f <sub>R</sub> = 100Hz	<10 <sup>-13</sup>	W/√Hz
Cross talk			1	%
Angle of incidence	φ	Δλ <sub>(Filter)</sub> < 1%*λ	8	Grad
Operating temperature range	T <sub>op</sub>		0 ... +70	°C
Storage temperature range	T <sub>st</sub>		-20 ... +80	°C
MSL (Moisture Sensitivity Level)		-	1	-
Soldering temperature	T	2...3 sec	240	°C
Reference voltage (see also chapter 9 Application Circuit)	VREF		0,4 ... VDD-0,4	V
Reverse voltage	V <sub>r</sub>		0...5	V

REVISIONS		
REV.	DESCRIPTION	APPROVED
1	V1.17	2006-03-01

## 6. CHARACTERISTIC CURVES

### 6.1 Typical spectral sensitivity<sup>1</sup>

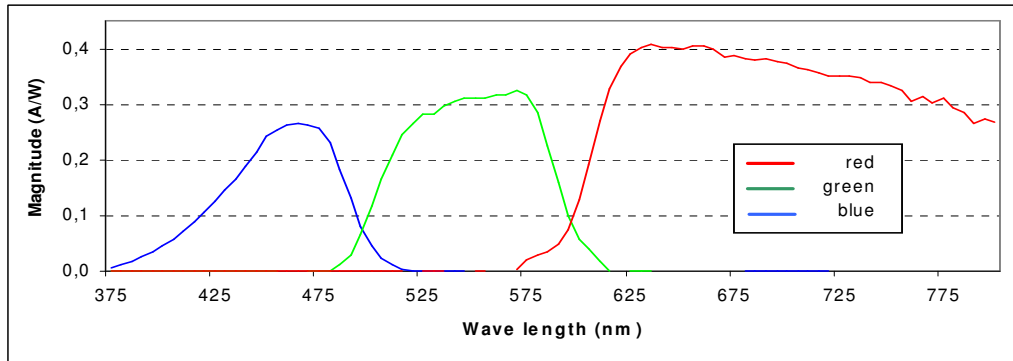

### 6.2 Dark current<sup>1</sup>

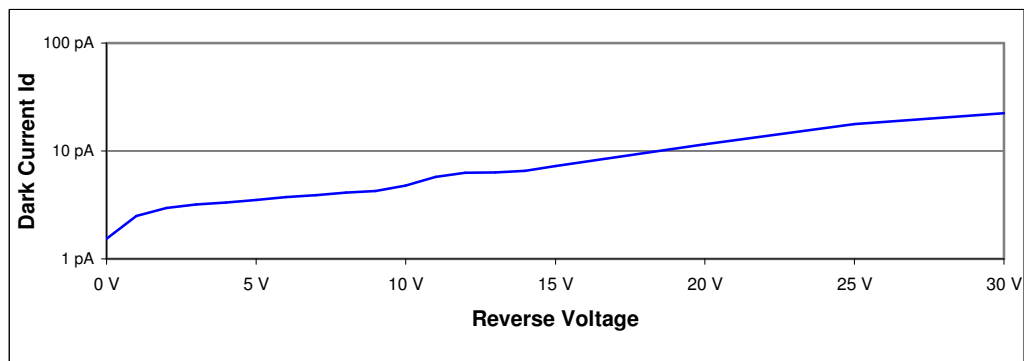

<sup>1</sup> Typical characteristic sensitivity; scanned by monochromatic light with FWHM 27nm, not suitable for narrow light, e.g. laser

REVISIONS		
REV.	DESCRIPTION	APPROVED
1	V1.17	2006-03-01

### 7. PACKAGE OVERVIEW

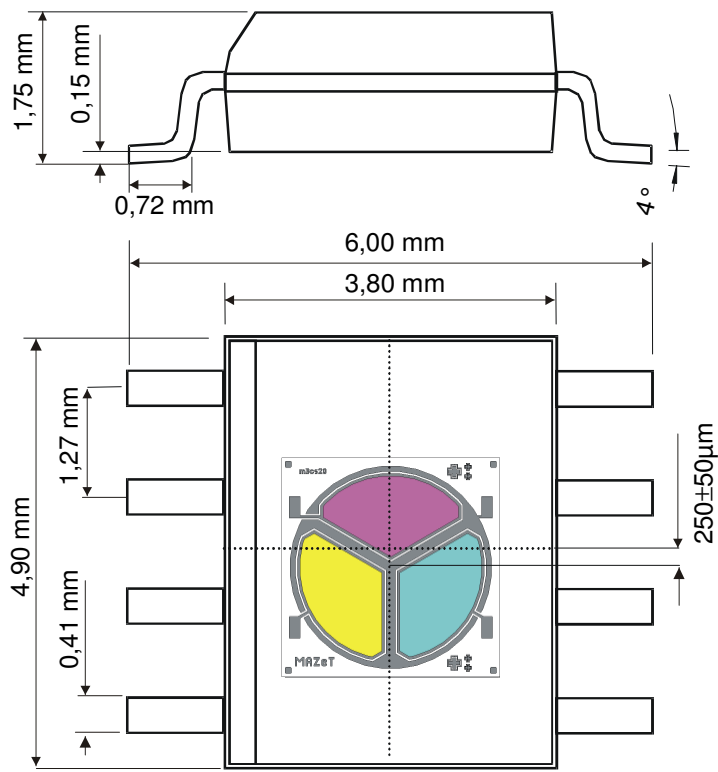

SOP8 Package (MCS3AS)

∅ diodes 2mm

### 8. SOLDERING PROFILE

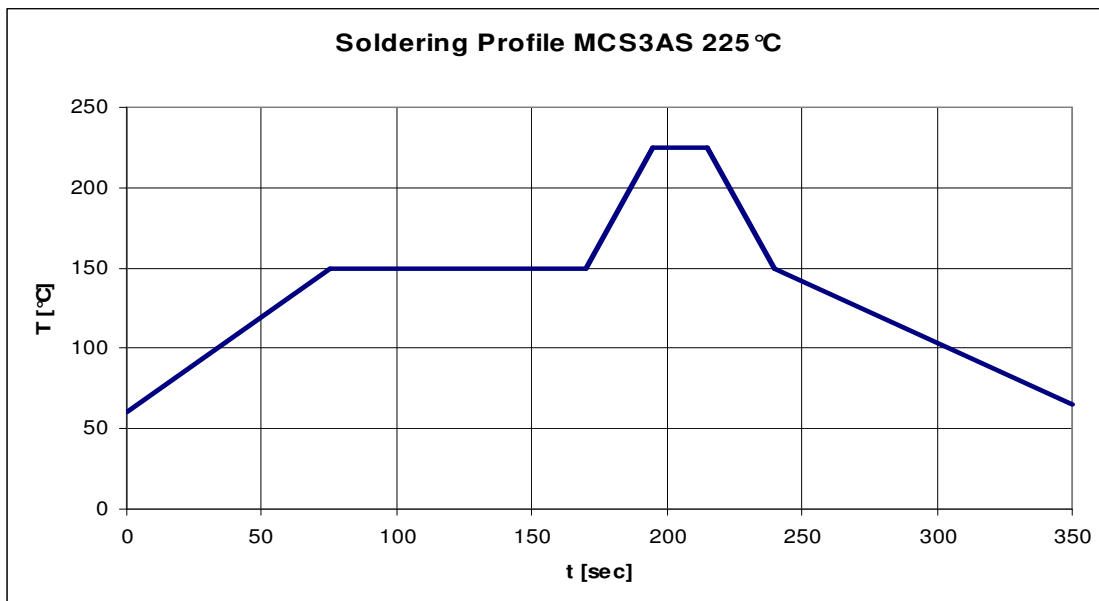

REVISIONS		
REV.	DESCRIPTION	APPROVED
1	V1.17	2006-03-01

### 9. PIN-CONFIGURATION

(Top view)

PIN	description
1	A3 green
2	nc
3	nc
4	A2 blue
5	A1 red
6	nc
7	TrD
8	K common cathode

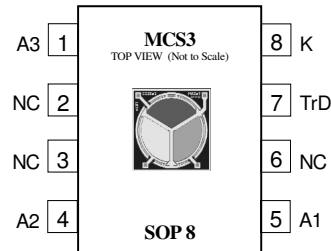

SOP8- package

### 10. APPLICATION CIRCUIT

Opposite figure shows a circuit for the conversion of photo current to an equivalent voltage. These voltage can be processed e.g. with an ADC. By the selection of suitable resistors the output voltage range can be adjusted to the photo current value. (for example the pin-programmable transimpedance amplifier MTI04 with the resistors 25kΩ, 500kΩ and 5MΩ)

$$R_x \approx \frac{\Delta V_{Out}}{\Delta I_{Photo}}$$

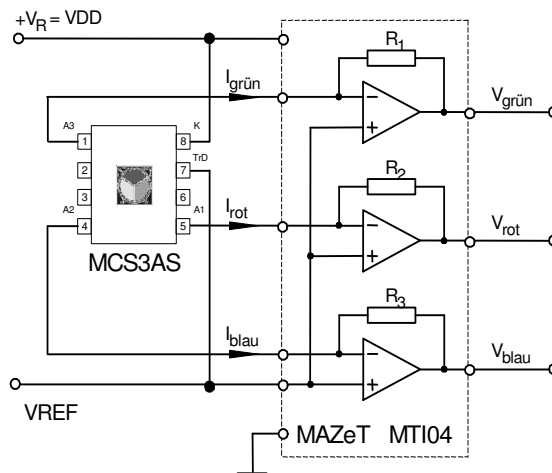

### 11. APPLICATION NOTE

It is recommended to use a light source with low infrared radiation for optimal operations of the colour sensor.

## 12. ORDERING INFORMATION

Colour sensor MCS3 with SOP8-package + transparent encapsulated (plastic) **MCS3AS**  
Evaluation board for JENCOLOUR sensors **MCS-EB1**

---

### WARNINGS

**Personal Injury** – Do not use these products as safety or emergency stop devices, or in any other applications where failure of the product could result in personal injury. **Failure to comply with these instructions could result in death or serious injury.**

**Misuse of Documentation** – The information presented in this data sheet is for reference only. Because this products are under development do not use this document as product installation guide. Before you start any development ask your supplier for the latest version of this sheet. **Failure to comply with these instructions could result in death or serious injury.**