

Cute-3-DD (MR11), lenses for Sharp GM2BB... (Double Dome) LEDs

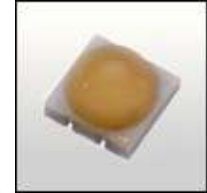

SHARP.



- Specially designed for Sharp GM2BB... (Double Dome) series of LEDs.
- Special care taken to make a uniform white or warm white illumination. Lenses work well with other colors, too.
- Lens material optical grade PMMA. Allows use of high current and temperature conditions (105°C/220°F)
- No lens holder. Fastening to heat sink with droplets of glue.
- Best available optical efficiency, up to 90%.

LENS TYPES

NAME	ORDERING CODE	FWHM Angle
Cute-3 Smooth Spot	C10754_Cute-3-SS-DD	±6°
Cute-3 Medium	C10755_Cute-3-M-DD	±12°
Cute-3 Wide	C10756_Cute-3-W-DD	±19°

© Ledil Oy – PRELIMINARY - Subject to change without prior notice

MEASUREMENT DATA

Relative Intensity of C10754_Cute-3-SS-DD

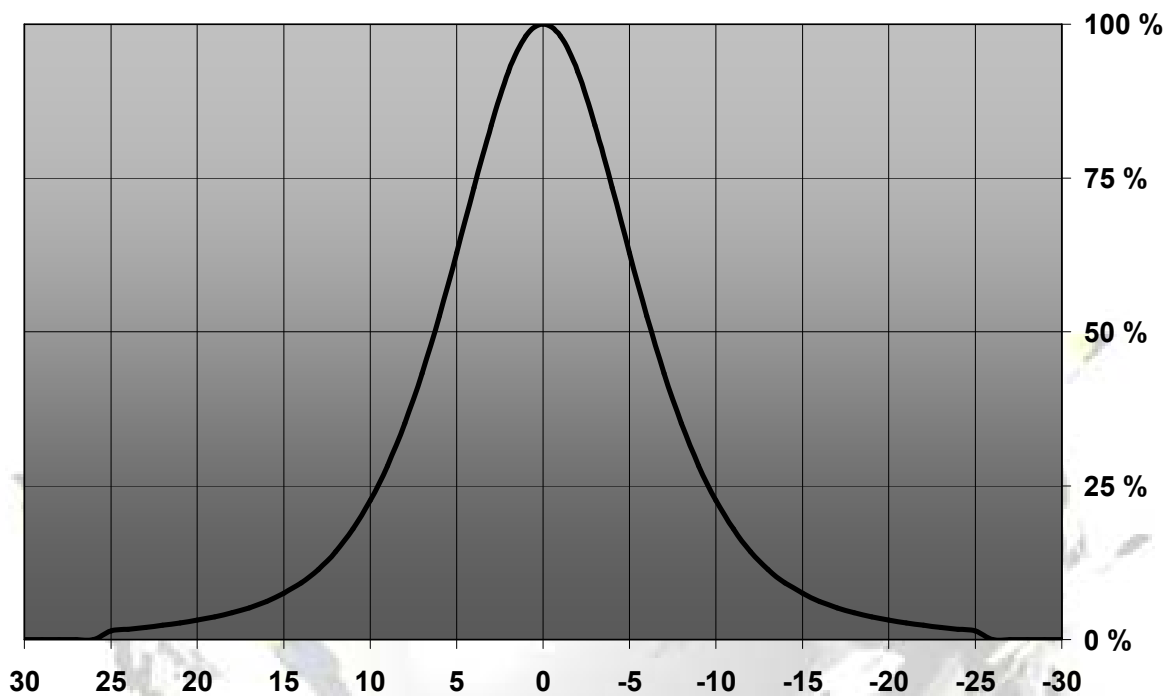

© Ledil Oy – PRELIMINARY - Subject to change without prior notice

Relative Intensity of C10755_Cute-3-M-DD

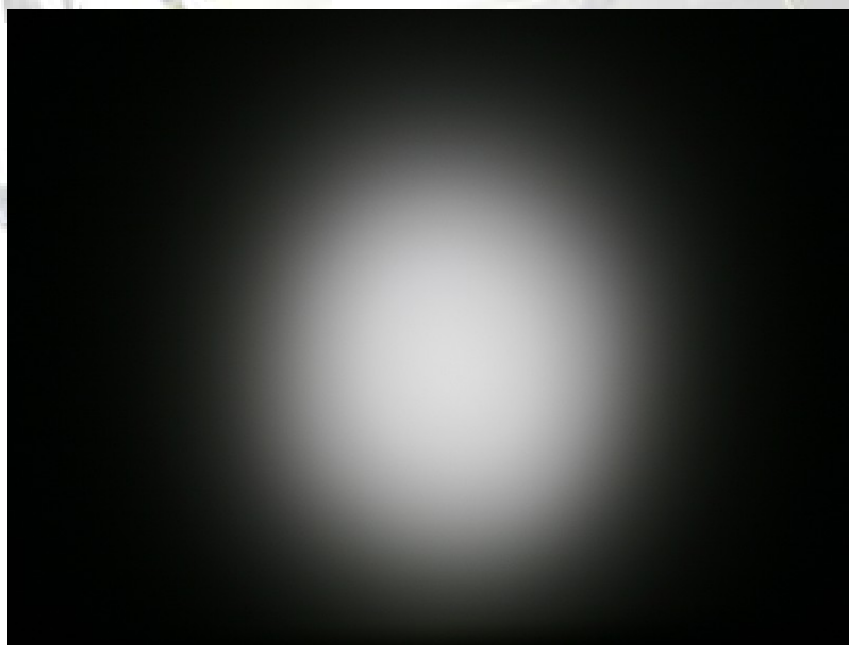
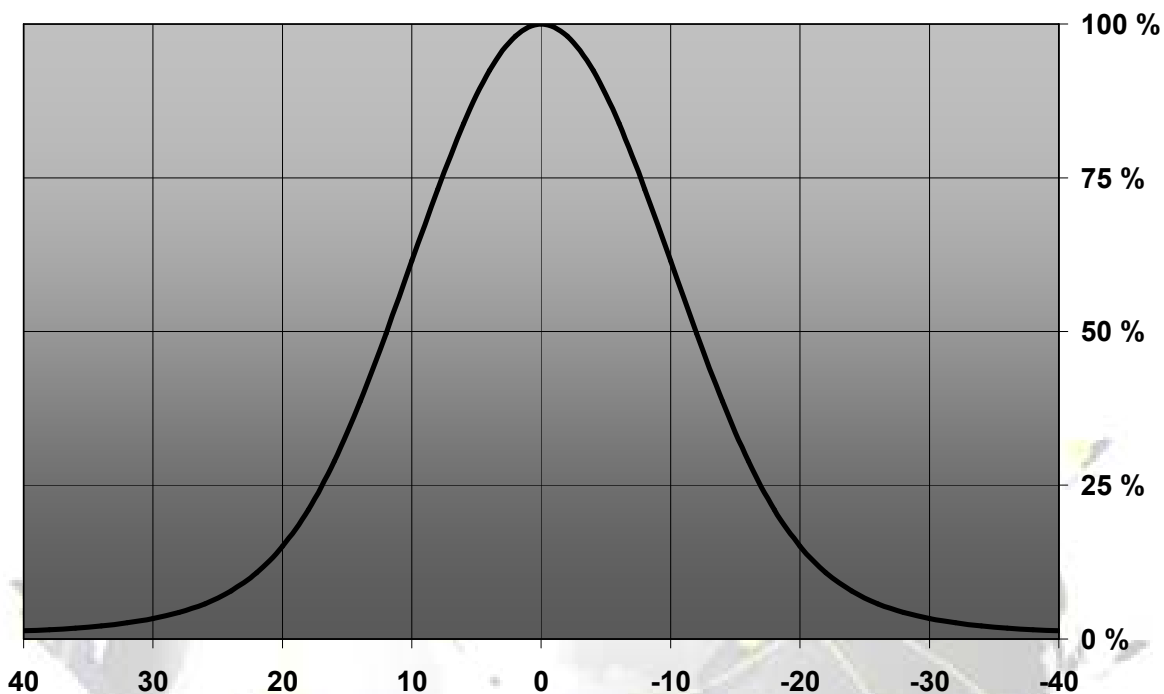

© Ledil Oy – PRELIMINARY - Subject to change without prior notice

Relative Intensity of C10756_Cute-3-W-DD

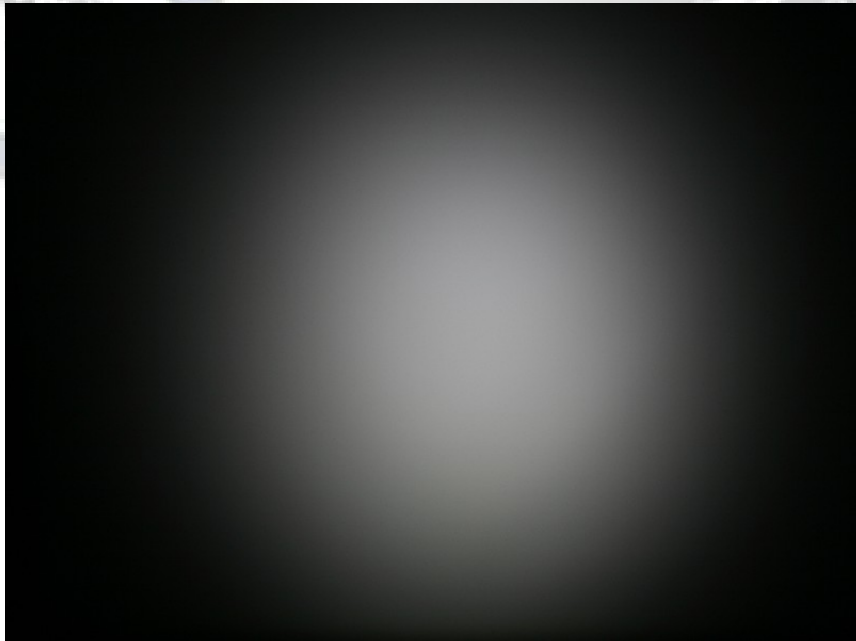
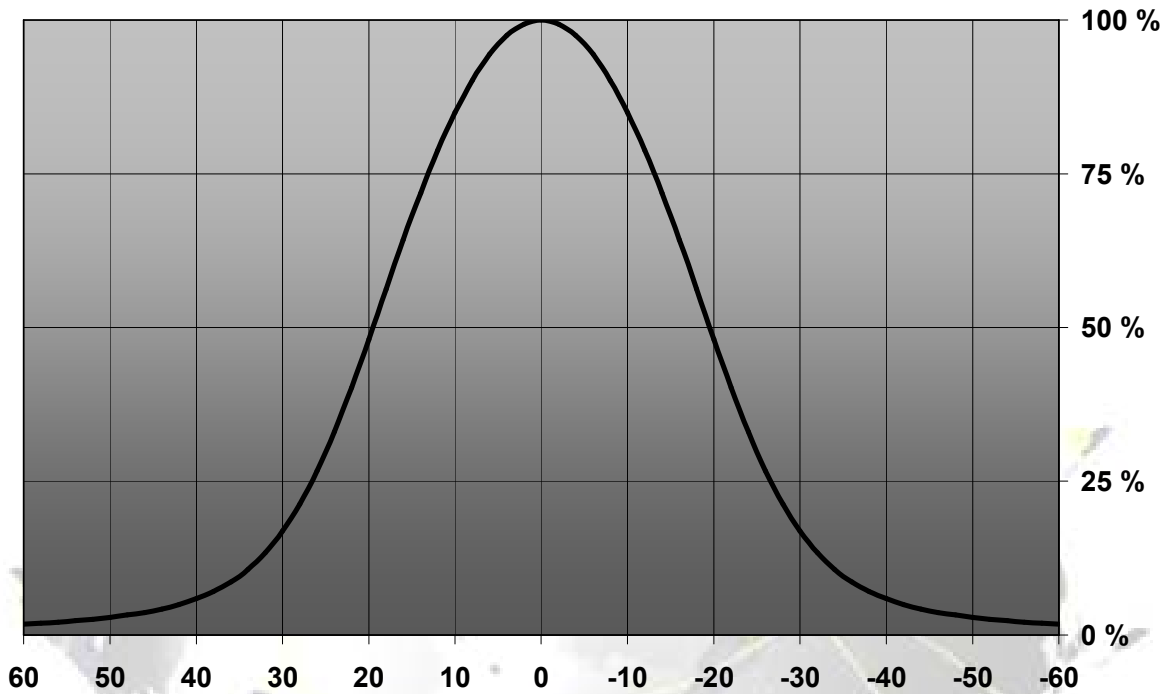

EULUMDAT & IES FILES AVAILABLE BY REQUEST

© Ledil Oy – PRELIMINARY - Subject to change without prior notice

DRAWINGS

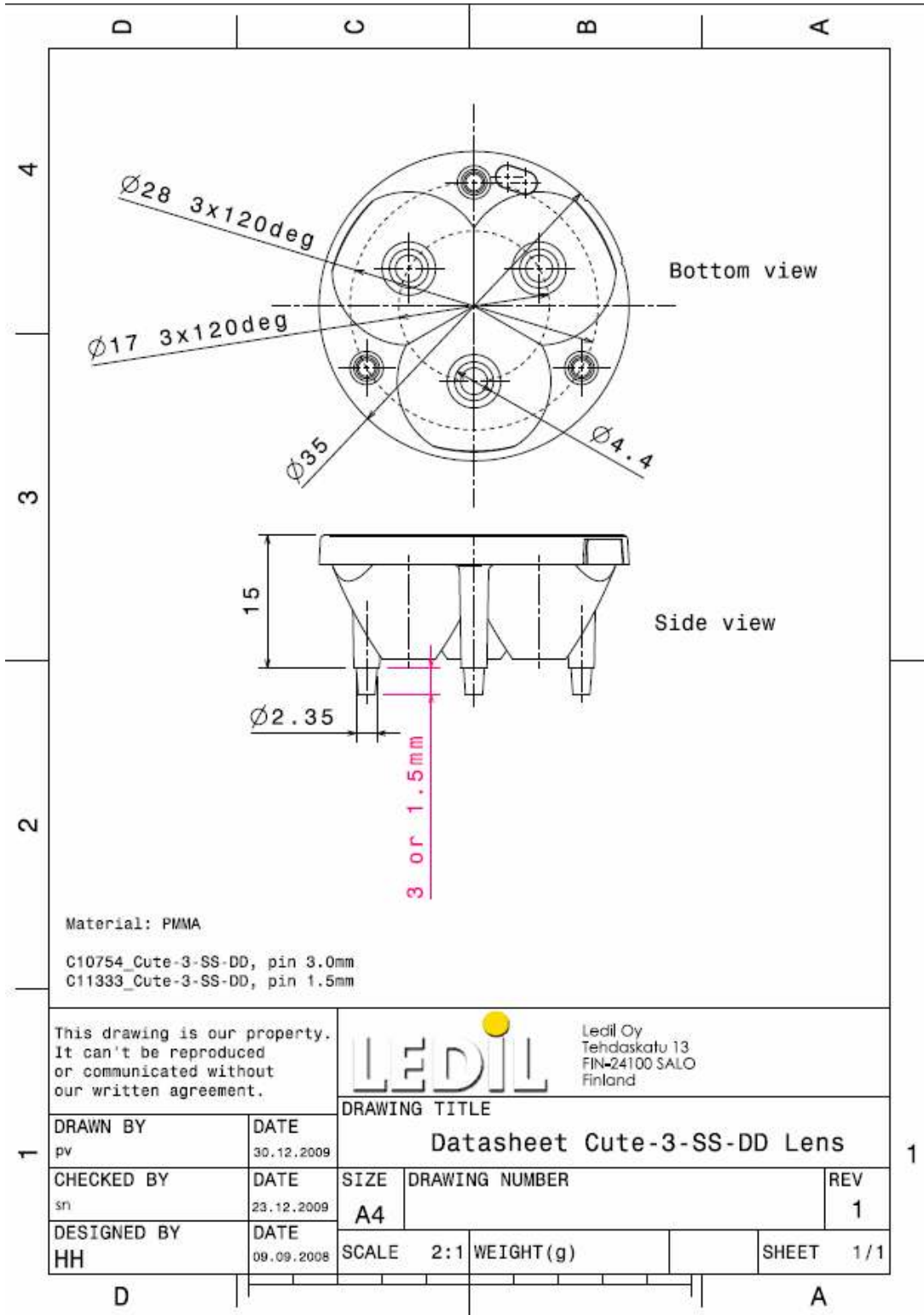

© Ledil Oy - PRELIMINARY - Subject to change without prior notice