

Cute-3-O-Plus MR11, lenses for Platinum & Golden Dragon+ LEDs

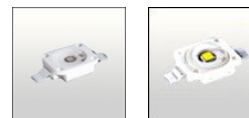

OSRAM
www.osram.com

- Specially designed for Osram-os Golden Dragon+ series of LEDs.
- Special care taken to make a uniform white or warm white illumination.
- Lenses work well with other colors, too.
- Lens material optical grade PMMA. Allows use of high current and temperature conditions
- Best available optical efficiency, up to 90%.

LENS TYPES

NAME	ORDERING CODE	FWHM Angle
Cute-3-O-Plus Smooth Spot	C10710_Cute-3-O-Plus-S	±5.6°
Cute-3-O-Plus Medium	C10711_Cute-3-O-Plus-M	±14°
Cute-3-O-Plus Wide	C10712_Cute-3-O-Plus-W	±16°

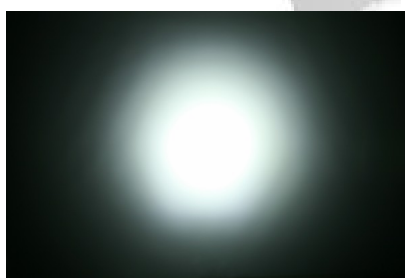

CUTE-3-O SMOOTH SPOT

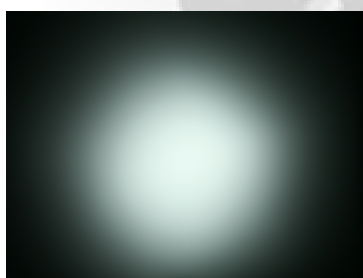

CUTE-3-O MEDIUM

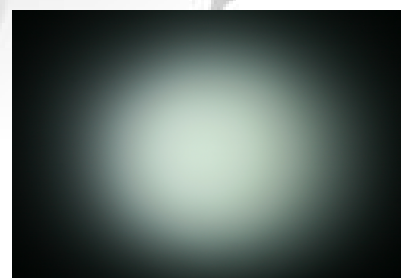

CUTE-3-O WIDE

© Ledil Oy – PRELIMINARY - Subject to change without prior notice

MEASUREMENT DATA

Relative Intensity of Cute-3-O-Plus-SS

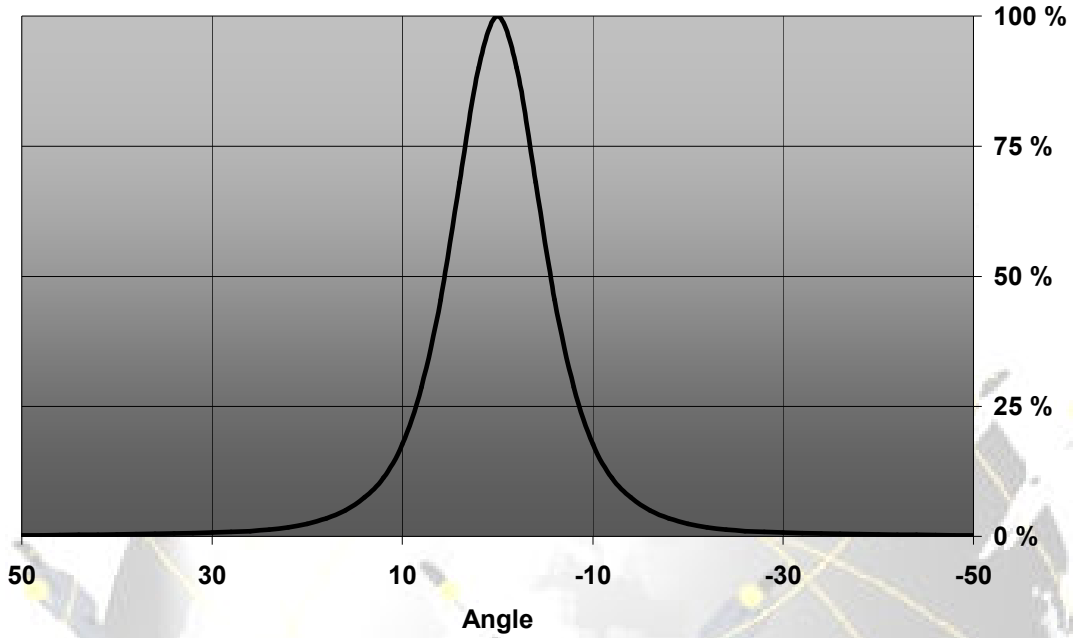

Relative Intensity of Cute-3-O-M

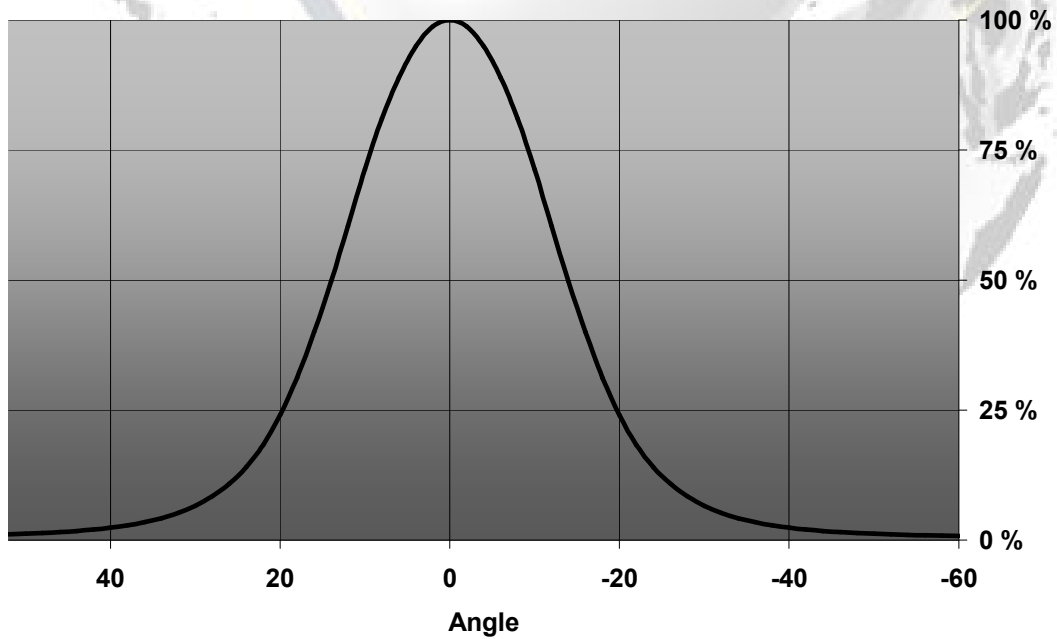

© Ledil Oy – PRELIMINARY - Subject to change without prior notice

Relative Intensity of C10712_Cute-3-O-Plus-W

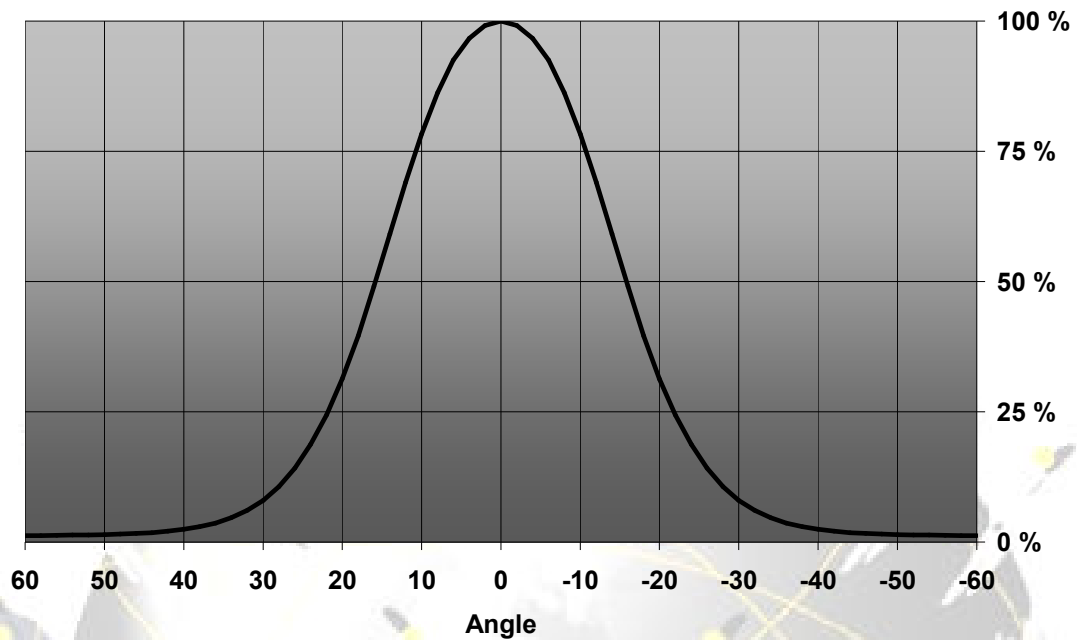

EULUMDAT & IES FILES AVAILABLE BY REQUEST

© Ledil Oy – PRELIMINARY - Subject to change without prior notice

Ledil Oy
 Tehdaskatu 13
 FIN-24100 SALO, Finland

www.ledil.com
 email: ledil@ledil.com
 FAX: +358-2-733 8001

2009-11-28

DRAWINGS

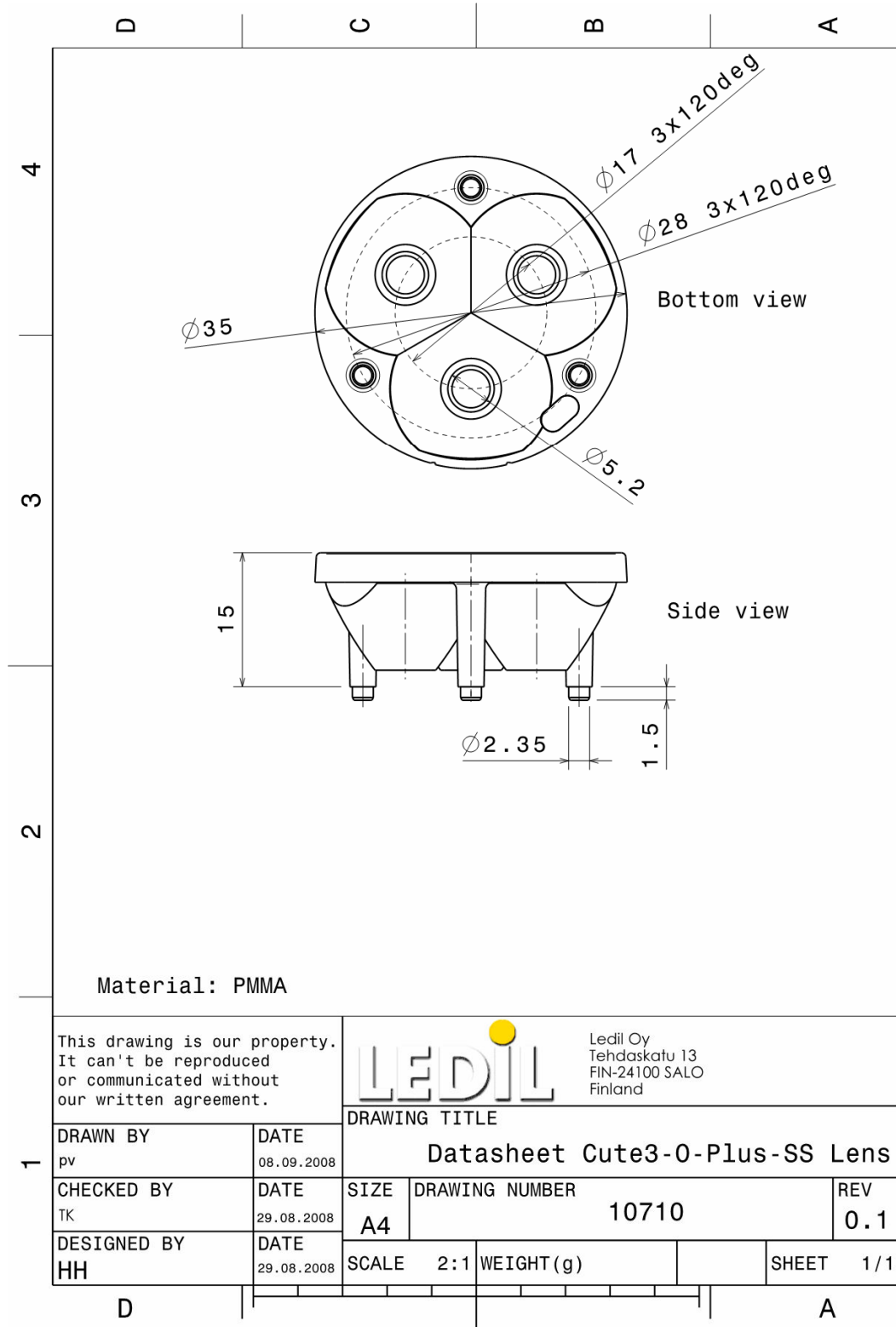

© Ledil Oy – PRELIMINARY - Subject to change without prior notice