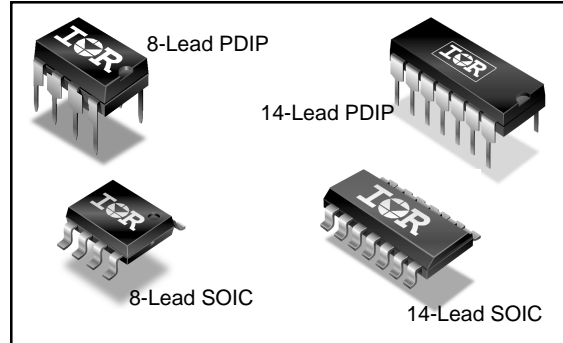


IRS2108/IRS21084(S)PbF HALF-BRIDGE DRIVER

Features

- Floating channel designed for bootstrap operation
- Fully operational to +600 V
- Tolerant to negative transient voltage, dV/dt immune
- Gate drive supply range from 10 V to 20 V
- Undervoltage lockout for both channels
- 3.3 V, 5 V, and 15 V input logic compatible
- Cross-conduction prevention logic
- Matched propagation delay for both channels
- High side output in phase with HIN input
- Low side output out of phase with LIN input
- Logic and power ground +/- 5 V offset
- Internal 540 ns deadtime, and programmable up to 5 μ s with one external R_{DT} resistor (IRS21084)
- Lower di/dt gate driver for better noise immunity

Packages



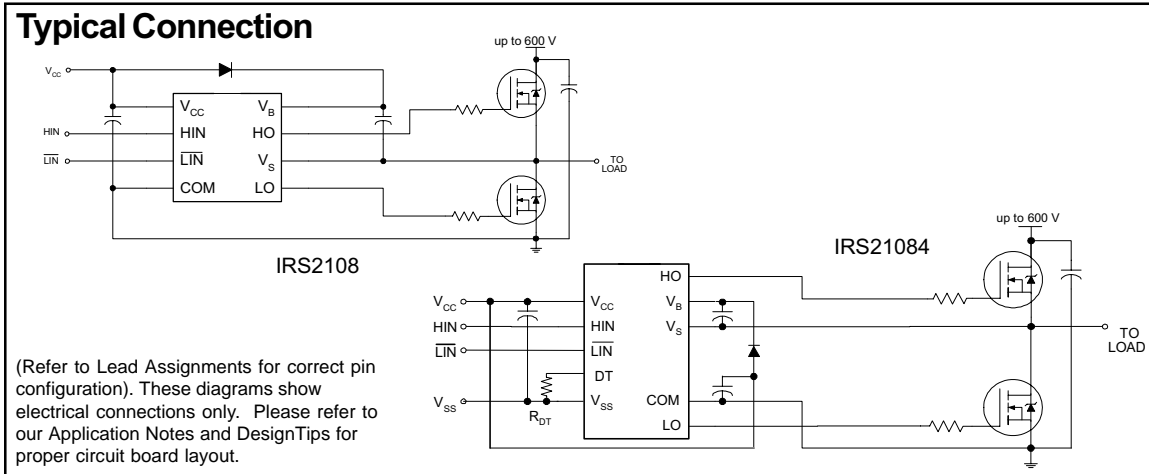
Description

The IRS2108/IRS21084 are high voltage, high speed power MOSFET and IGBT drivers with dependent high and low side referenced output channels. Proprietary HVIC and latch immune CMOS technologies enable ruggedized monolithic construction. The logic input is compatible with standard CMOS or LSTTL output, down to 3.3 V logic. The output drivers feature a high pulse current buffer stage designed for minimum driver cross-conduction. The floating channel can be used to drive an N-channel power MOSFET or IGBT in the high side configuration which operates up to 600 V.

Feature Comparison

Part	Input logic	Cross-conduction prevention logic	Deadtime (ns)	Ground Pins	Ton/Toff (ns)
2106/2301	HIN/LIN	no	none	COM	220/200
21064				Vss/COM	
2108	HIN/LIN	yes	Internal 540	COM	220/200
21084				Vss/COM	
2109/2302	IN/SD	yes	Internal 540	COM	750/200
21094				Vss/COM	
2304	HIN/LIN	yes	Internal 100	COM	160/140

Typical Connection



Absolute Maximum Ratings

Absolute maximum ratings indicate sustained limits beyond which damage to the device may occur. All voltage parameters are absolute voltages referenced to COM. The thermal resistance and power dissipation ratings are measured under board mounted and still air conditions.

Symbol	Definition	Min.	Max.	Units	
V _B	High side floating absolute voltage	-0.3	625	V	
V _S	High side floating supply offset voltage	V _B - 25	V _B + 0.3		
V _{HO}	High side floating output voltage	V _S - 0.3	V _B + 0.3		
V _{CC}	Low side and logic fixed supply voltage	-0.3	25		
V _{LO}	Low side output voltage	-0.3	V _{CC} + 0.3		
DT	Programmable deadtime pin voltage (IRS21084 only)	V _{SS} - 0.3	V _{CC} + 0.3		
V _{IN}	Logic input voltage (HIN & LIN)	V _{SS} - 0.3	V _{CC} + 0.3		
V _{SS}	Logic ground (IRS21084 only)	V _{CC} - 25	V _{CC} + 0.3		
dV _S /dt	Allowable offset supply voltage transient	—	50	V/ns	
P _D	Package power dissipation @ TA ≤ +25 °C	(8 lead PDIP)	—	1.0	W
		(8 lead SOIC)	—	0.625	
		(14 lead PDIP)	—	1.6	
		(14 lead SOIC)	—	1.0	
R _{thJA}	Thermal resistance, junction to ambient	(8 lead PDIP)	—	125	°C/W
		(8 lead SOIC)	—	200	
		(14 lead PDIP)	—	75	
		(14 lead SOIC)	—	120	
T _J	Junction temperature	—	150	°C	
T _S	Storage temperature	-50	150		
T _L	Lead temperature (soldering, 10 seconds)	—	300		

Recommended Operating Conditions

The input/output logic timing diagram is shown in Fig. 1. For proper operation the device should be used within the recommended conditions. The V_S and V_{SS} offset rating are tested with all supplies biased at a 15 V differential.

Symbol	Definition	Min.	Max.	Units	
V _B	High side floating supply absolute voltage	V _S + 10	V _S + 20	V	
V _S	High side floating supply offset voltage	Note 1	600		
V _{HO}	High side floating output voltage	V _S	V _B		
V _{CC}	Low side and logic fixed supply voltage	10	20		
V _{LO}	Low side output voltage	0	V _{CC}		
V _{IN}	Logic input voltage	IRS2108	COM		V _{CC}
		IRS21084	V _{SS}		V _{CC}
DT	Programmable deadtime pin voltage (IRS21084 only)	V _S	V _{CC}		
V _{SS}	Logic ground (IRS21084 only)	-5	5		
T _A	Ambient temperature	-40	125	°C	

Note 1: Logic operational for V_S of -5 V to +600 V. Logic state held for V_S of -5 V to -V_{BS}. (Please refer to the Design Tip DT97-3 for more details).

Dynamic Electrical Characteristics

$V_{BIAS} (V_{CC}, V_{BS}) = 15\text{ V}$, $V_{SS} = \text{COM}$, $C_L = 1000\text{ pF}$, $T_A = 25\text{ }^\circ\text{C}$, $DT = V_{SS}$ unless otherwise specified.

Symbol	Definition	Min.	Typ.	Max.	Units	Test Conditions
t_{on}	Turn-on propagation delay	—	220	300	ns	$V_S = 0\text{ V}$
t_{off}	Turn-off propagation delay	—	200	280		$V_S = 0\text{ V or } 600\text{ V}$
MT	Delay matching $ t_{on} - t_{off} $	—	0	30		
t_r	Turn-on rise time	—	100	220		$V_S = 0\text{ V}$
t_f	Turn-off fall time	—	35	80	μs	$R_{DT} = 0\ \Omega$
DT	Deadtime: LO turn-off to HO turn-on (DTLO-HO) & HO turn-off to LO turn-on (DTHO-LO)	400 4	540 5	680 6		$R_{DT} = 200\text{ k}\Omega$ (IR21084)
MDT	Deadtime matching = $ DT_{LO-HO} - DT_{HO-LO} $	— —	0 0	60 600	ns	$R_{DT} = 0\ \Omega$
						$R_{DT} = 200\text{ k}\Omega$ (IR21084)

Static Electrical Characteristics

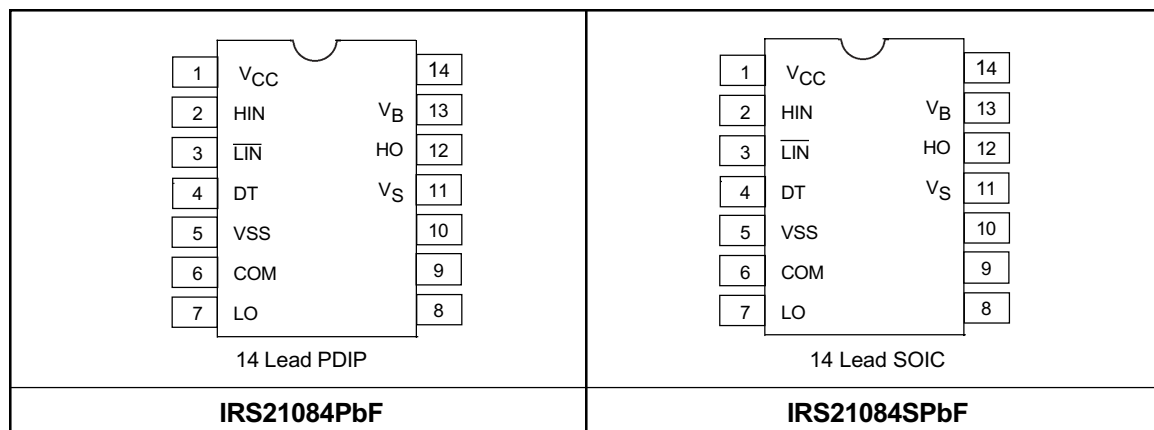
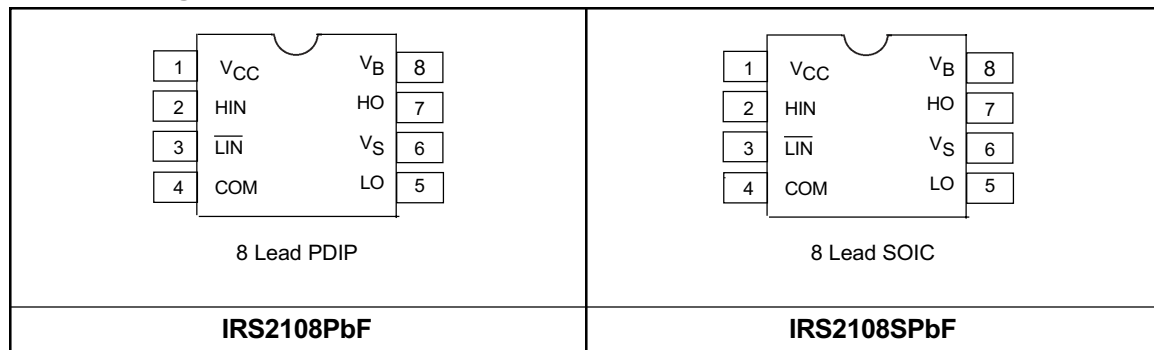
$V_{BIAS} (V_{CC}, V_{BS}) = 15\text{ V}$, $V_{SS} = \text{COM}$, $DT = V_{SS}$ and $T_A = 25\text{ }^\circ\text{C}$ unless otherwise specified. The V_{IL} , V_{IH} , and I_{IN} parameters are referenced to V_{SS}/COM and are applicable to the respective input leads: HIN and LIN. The V_O , I_O , and R_{on} parameters are referenced to COM and are applicable to the respective output leads: HO and LO.

Symbol	Definition	Min.	Typ.	Max.	Units	Test Conditions
V_{IH}	Logic "1" input voltage for HIN & logic "0" for LIN	2.5	—	—	V	$V_{CC} = 10\text{ V to } 20\text{ V}$
V_{IL}	Logic "0" input voltage for HIN & logic "1" for LIN	—	—	0.8		
V_{OH}	High level output voltage, $V_{BIAS} - V_O$	—	0.05	0.2		$I_O = 2\text{ mA}$
V_{OL}	Low level output voltage, V_O	—	0.02	0.1	μA	$V_B = V_S = 600\text{ V}$
I_{LK}	Offset supply leakage current	—	—	50		$V_{IN} = 0\text{ V or } 5\text{ V}$
I_{QBS}	Quiescent V_{BS} supply current	20	75	130	mA	$V_{IN} = 0\text{ V or } 5\text{ V}$
I_{QCC}	Quiescent V_{CC} supply current	0.4	1.0	1.6		$R_{DT} = 0\ \Omega$
I_{IN+}	Logic "1" input bias current	—	5	20	μA	$HIN = 5\text{ V}, \overline{LIN} = 0\text{ V}$
I_{IN-}	Logic "0" input bias current	—	—	2		$HIN = 0\text{ V}, \overline{LIN} = 5\text{ V}$
V_{CCUV+} V_{BSUV+}	V_{CC} and V_{BS} supply undervoltage positive going threshold	8.0	8.9	9.8	V	
V_{CCUV-} V_{BSUV-}	V_{CC} and V_{BS} supply undervoltage negative going threshold	7.4	8.2	9.0		
V_{CCUVH} V_{BSUVH}	Hysteresis	0.3	0.7	—		
I_{O+}	Output high short circuit pulsed current	120	290	—	mA	$V_O = 0\text{ V},$ $PW \leq 10\ \mu\text{s}$
I_{O-}	Output low short circuit pulsed current	250	600	—		$V_O = 15\text{ V},$ $PW \leq 10\ \mu\text{s}$

Lead Definitions

Symbol	Description
HIN	Logic input for high side gate driver output (HO), in phase (referenced to COM for IRS2108 and VSS for IRS21084)
LIN	Logic input for low side gate driver output (LO), out of phase (referenced to COM for IRS2108 and VSS for IRS21084)
DT	Programmable dead-time lead, referenced to VSS (IR21084 only)
VSS	Logic ground (IRS21084 only)
V _B	High side floating supply
HO	High side gate driver output
V _S	High side floating supply return
V _{CC}	Low side and logic fixed supply
LO	Low side gate driver output
COM	Low side return

Lead Assignments



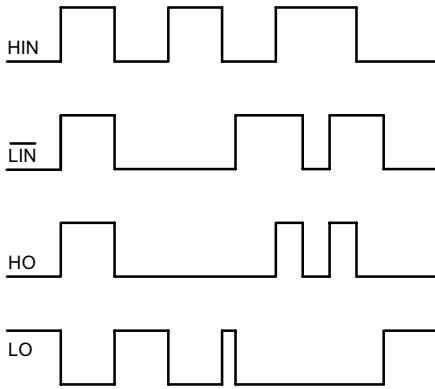


Figure 1. Input/Output Timing Diagram

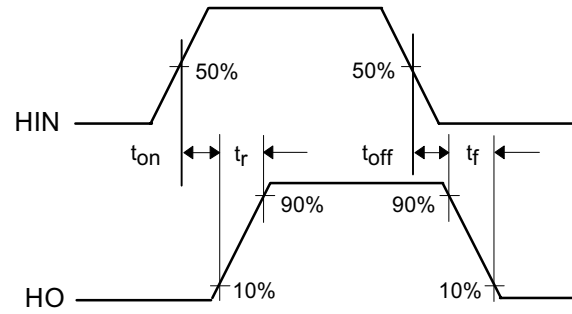
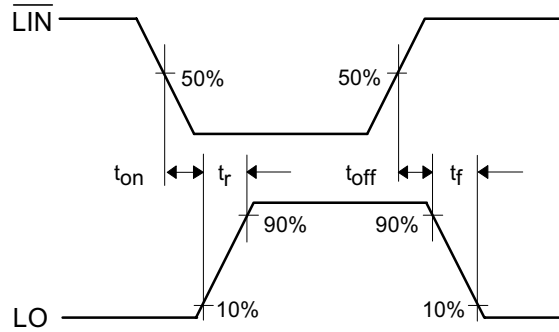


Figure 2. Switching Time Waveform Definitions

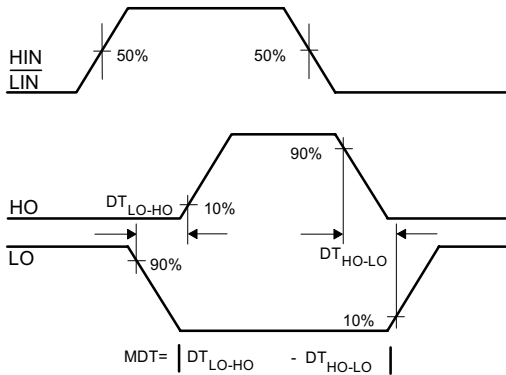


Figure 3. Deadtime Waveform Definitions

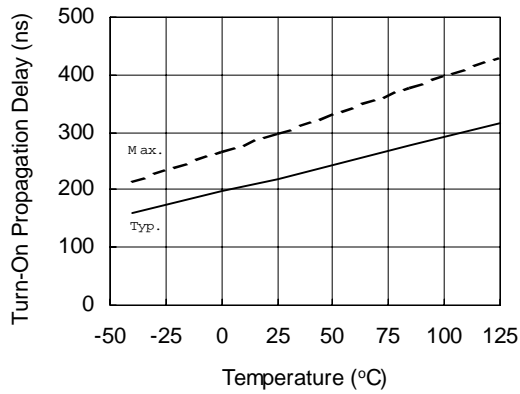


Figure 4A. Turn-On Propagation Delay vs. Temperature

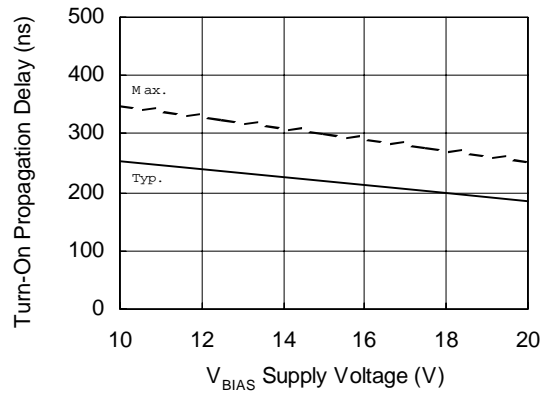


Figure 4B. Turn-On Propagation Delay vs. Supply Voltage

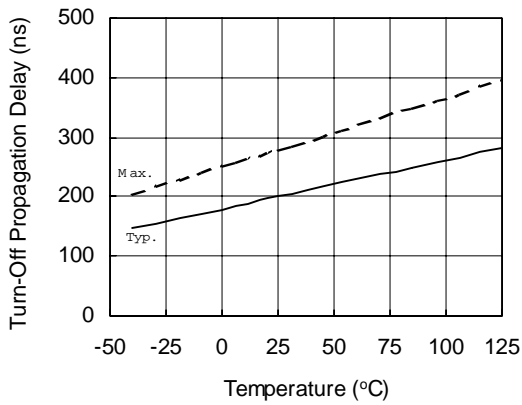


Figure 5A. Turn-Off Propagation Delay vs. Temperature

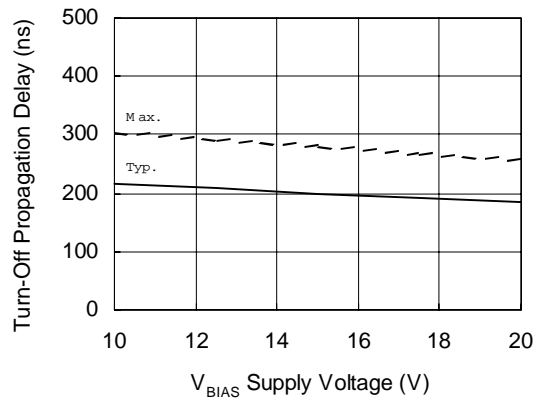


Figure 5B. Turn-Off Propagation Delay vs. Supply Voltage

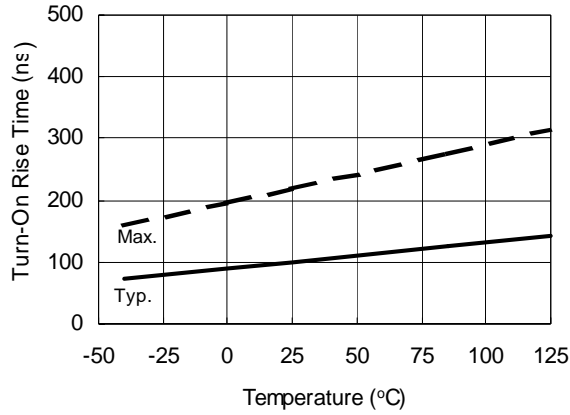


Figure 6A. Turn-On Rise Time vs. Temperature

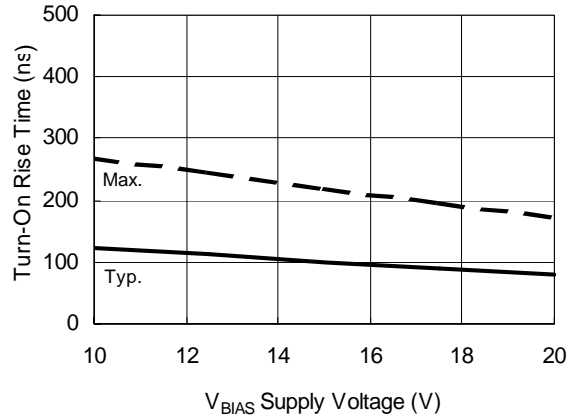


Figure 6B. Turn-On Rise Time vs. Supply Voltage

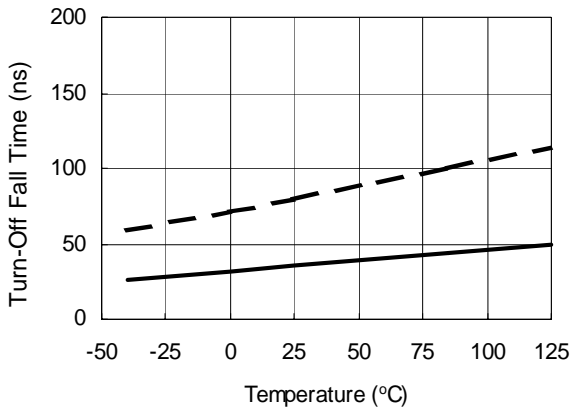


Figure 7A. Turn-Off Fall Time vs. Temperature

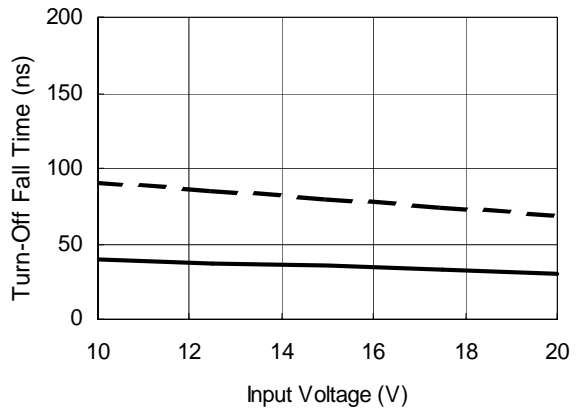


Figure 7B. Turn-Off Fall Time vs. Input voltage

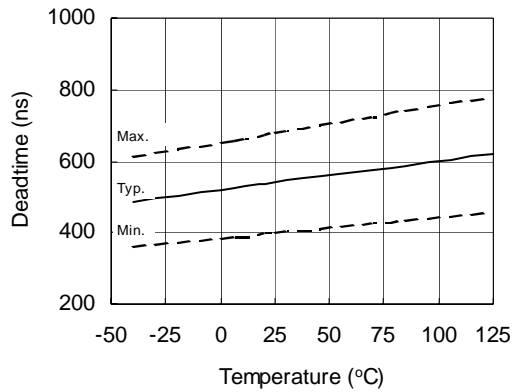


Figure 8A. Deadtime vs. Temperature

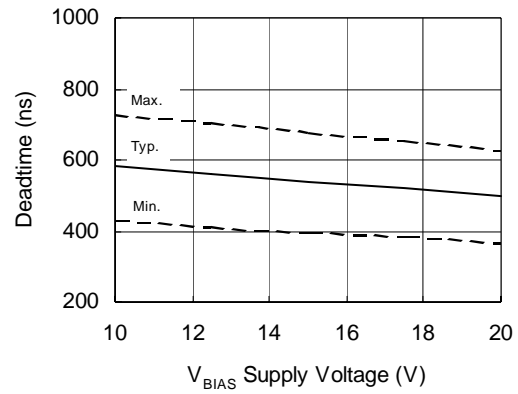


Figure 8B. Deadtime vs. Supply Voltage

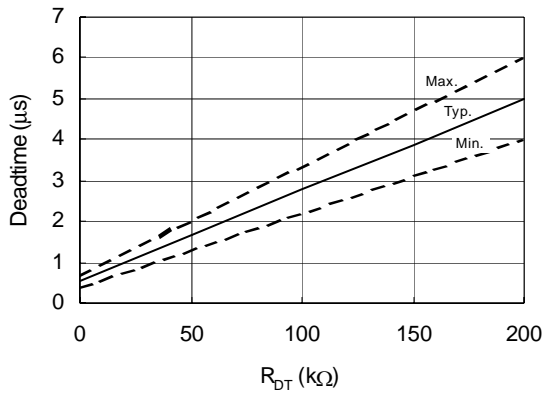


Figure 8C. Deadtime vs. R_{DT}
 (IR21084 Only)

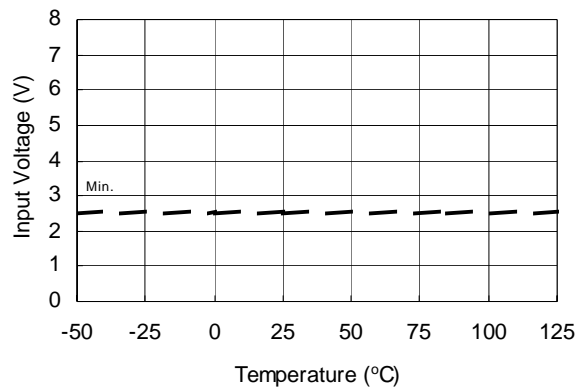


Figure 9A. Logic "1" Input Voltage
 vs. Temperature

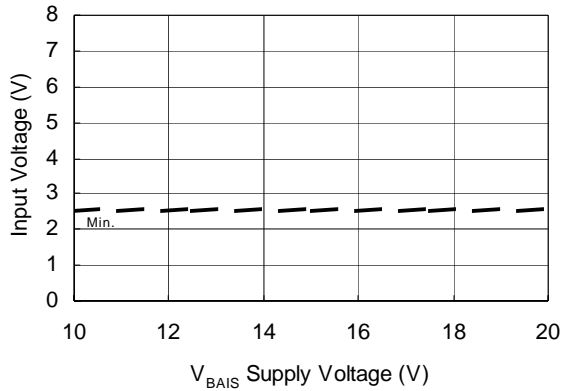


Figure 9B. Logic "1" Input Voltage vs. Supply Voltage

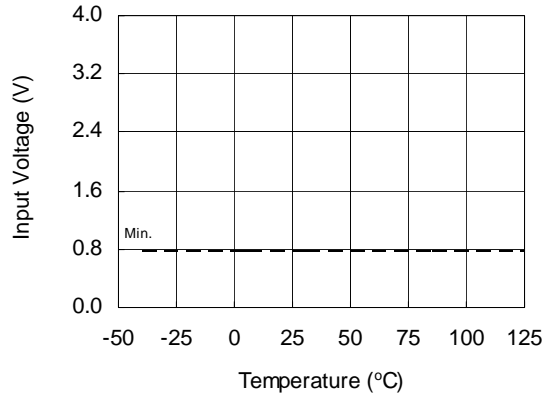


Figure 10A. Logic "0" Input Voltage vs. Temperature

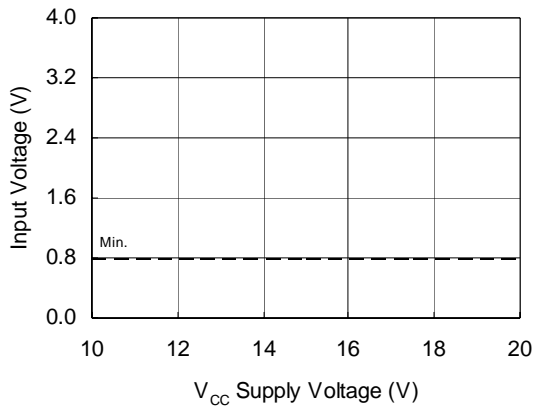


Figure 10B. Logic "0" Input Voltage vs. Supply Voltage

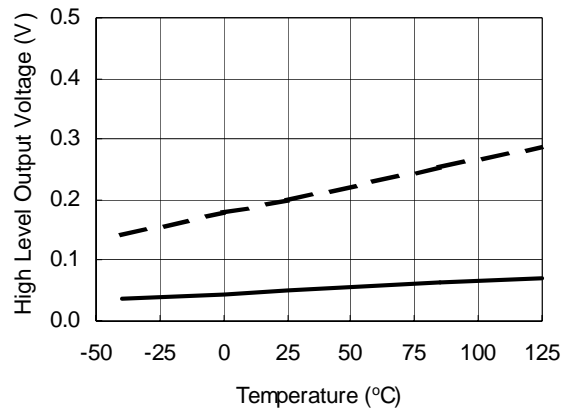


Figure 11A. High Level Output Voltage vs. Temperature

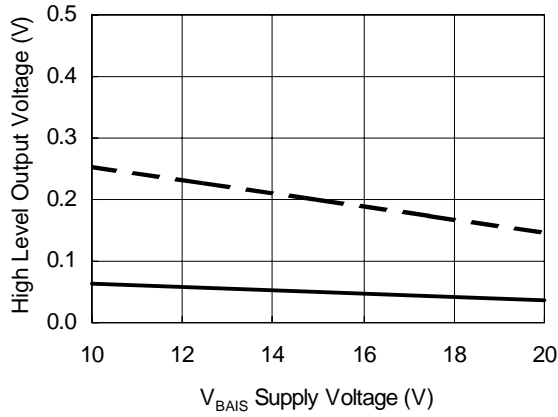


Figure 11B. High Level Output Voltage vs. Supply Voltage

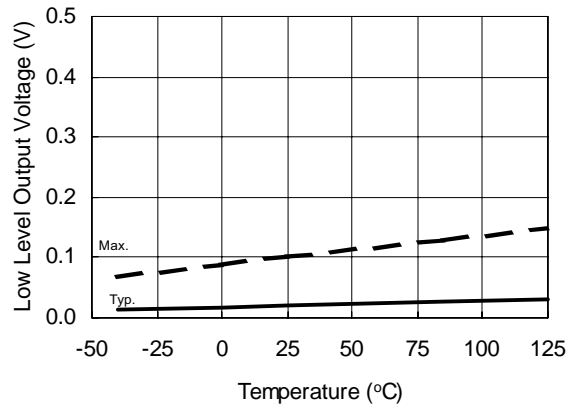


Figure 12A. Low Level Output Voltage vs. Temperature

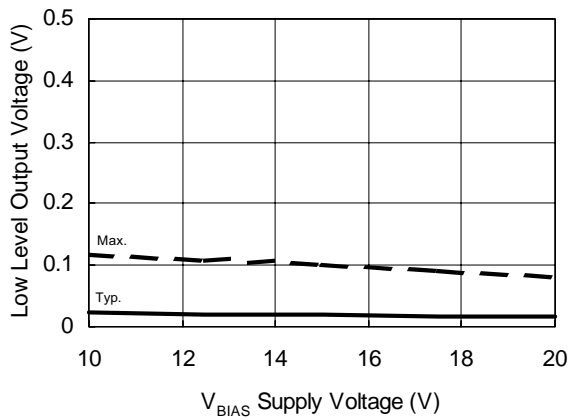


Figure 12B. Low Level Output Voltage vs. Supply Voltage

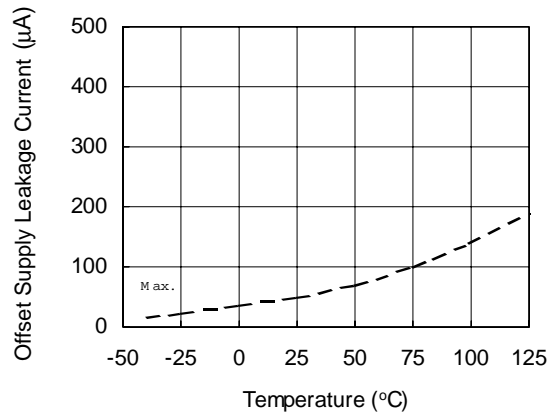


Figure 13A. Offset Supply Leakage Current vs. Temperature

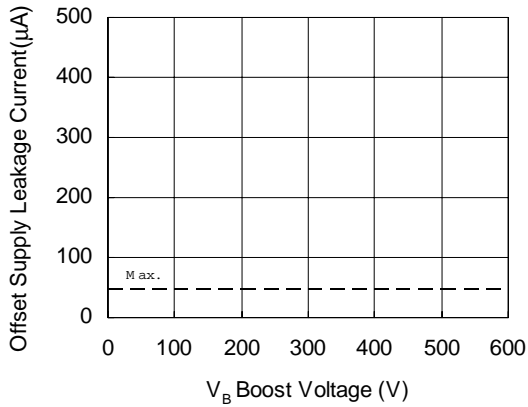


Figure 13B. Offset Supply Leakage Current vs. Temperature

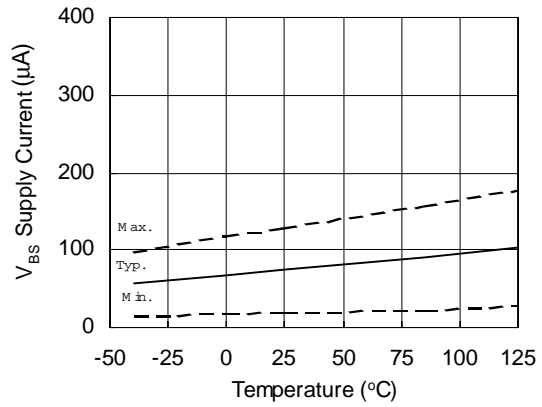


Figure 14A. V_{BS} Supply Current vs. Temperature

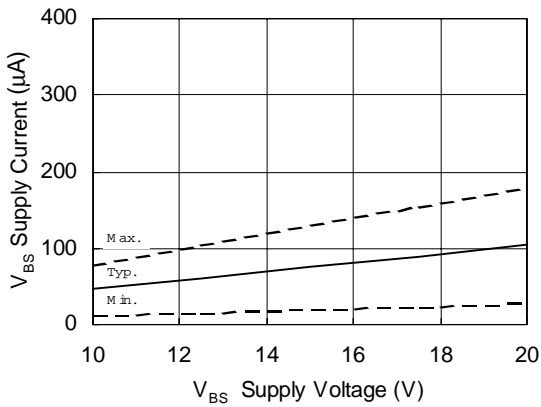


Figure 14B. V_{BS} Supply Current vs. Supply Voltage

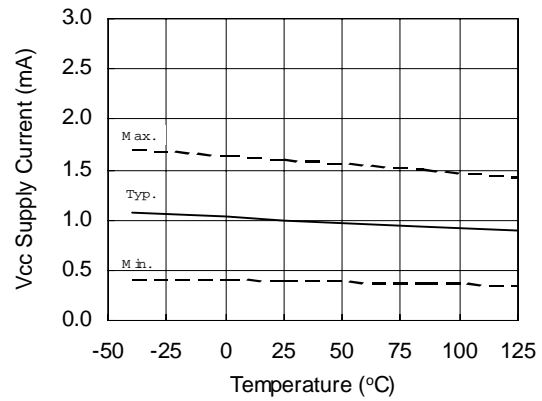


Figure 15A. V_{CC} Supply Current vs. Temperature

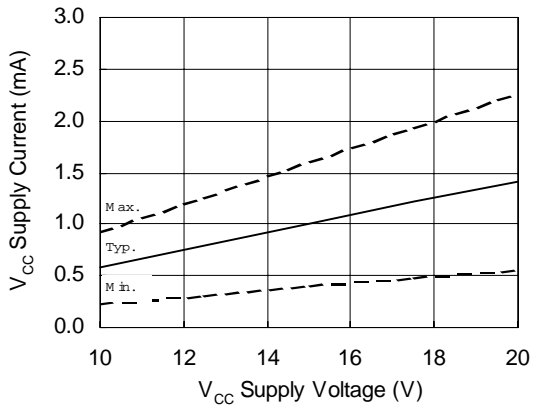


Figure 15B. V_{CC} Supply Current vs. Supply Voltage

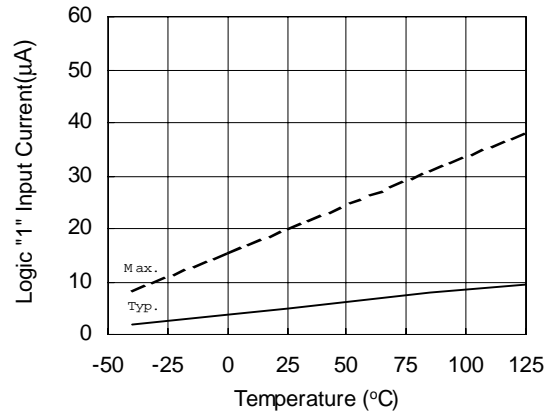


Figure 16A. Logic "1" Input Current vs. Temperature

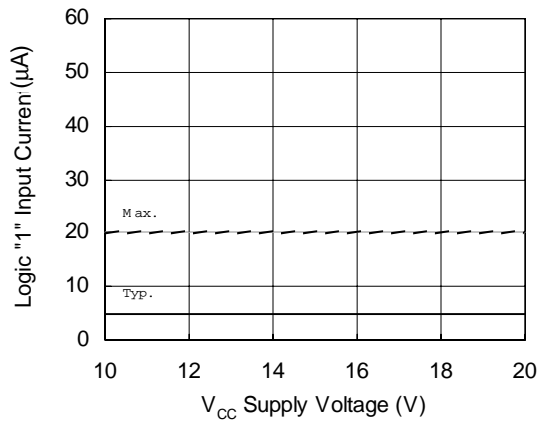


Figure 16B. Logic "1" Input Current vs. Supply Voltage

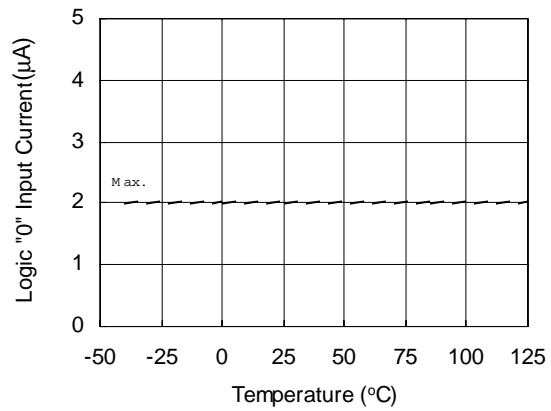


Figure 17A. Logic "0" Input Current vs. Temperature

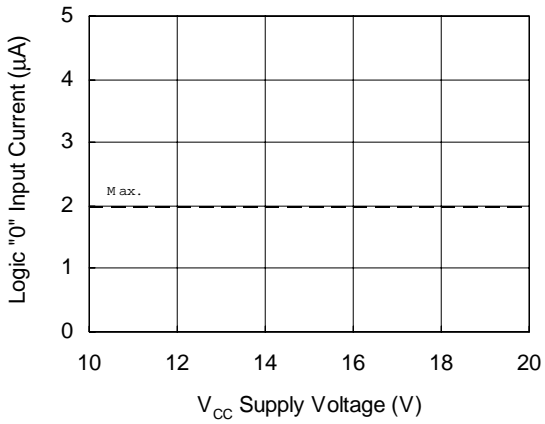


Figure 17B. Logic "0" Input Current vs. Supply Voltage

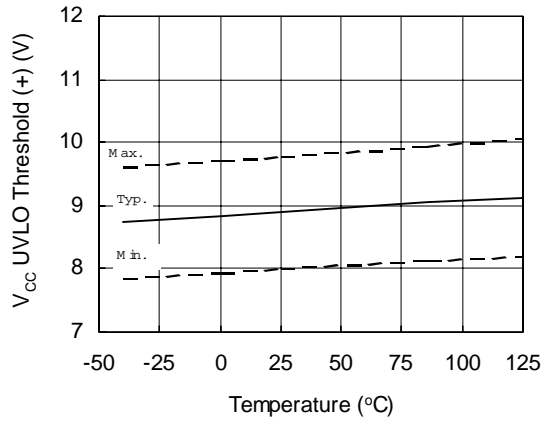


Figure 18. V_{CC} Undervoltage Threshold (+) vs. Temperature

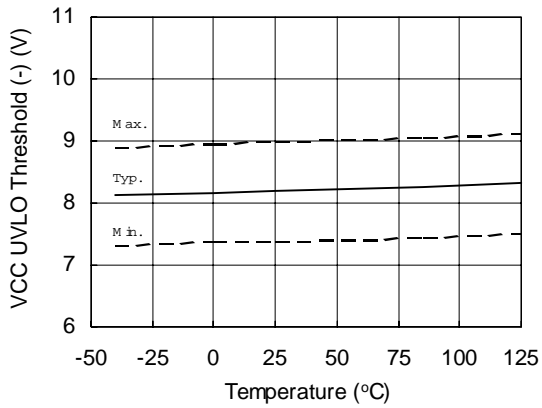


Figure 19. V_{CC} Undervoltage Threshold (-) vs. Temperature

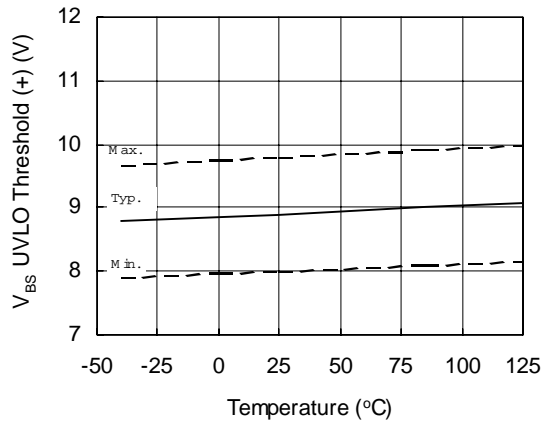


Figure 20. V_{BS} Undervoltage Threshold (+) vs. Temperature

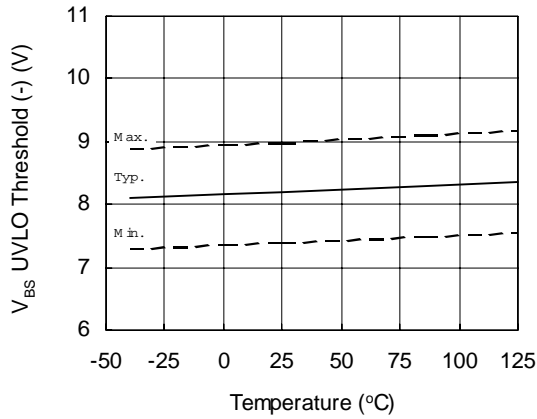


Figure 21. V_{BS} Undervoltage Threshold (-) vs. Temperature

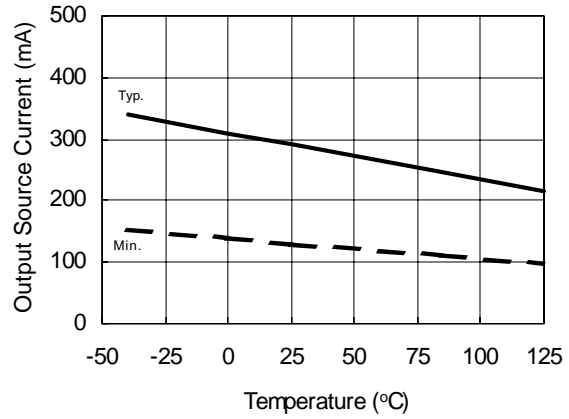


Figure 22A. Output Source Current vs. Temperature

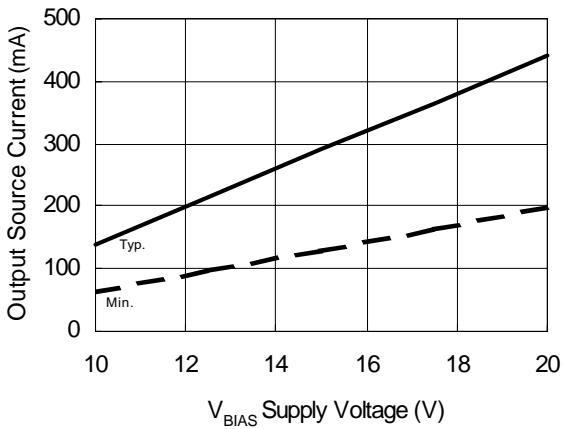


Figure 22B. Output Source Current vs. Supply Voltage

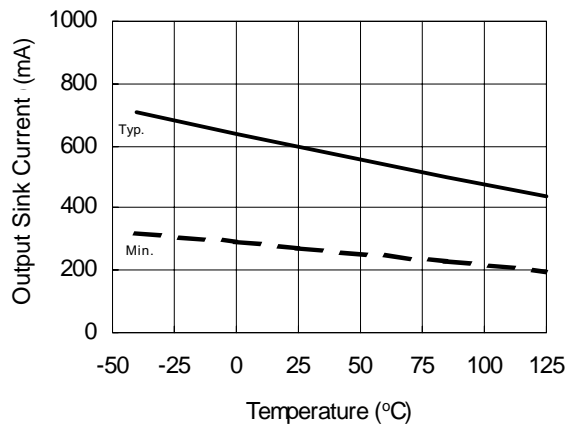


Figure 23A. Output Sink Current vs. Temperature

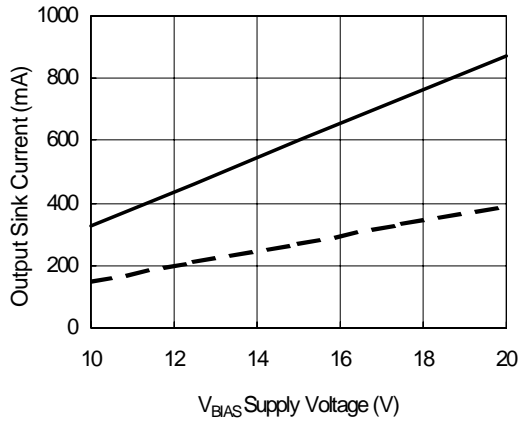


Figure 23B. Output Sink Current vs. Supply Voltage

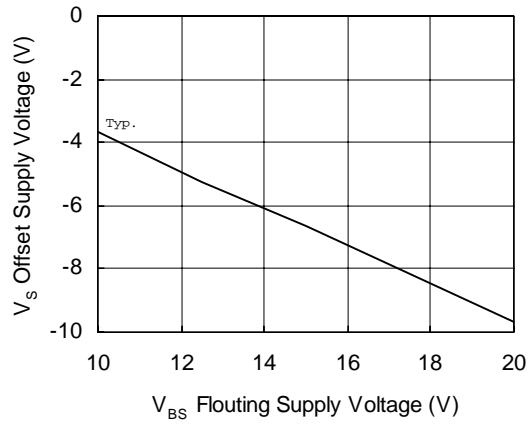
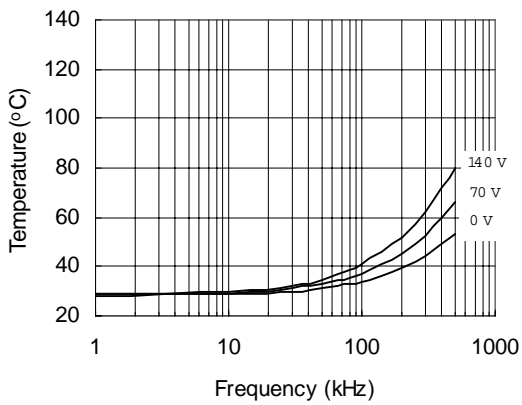
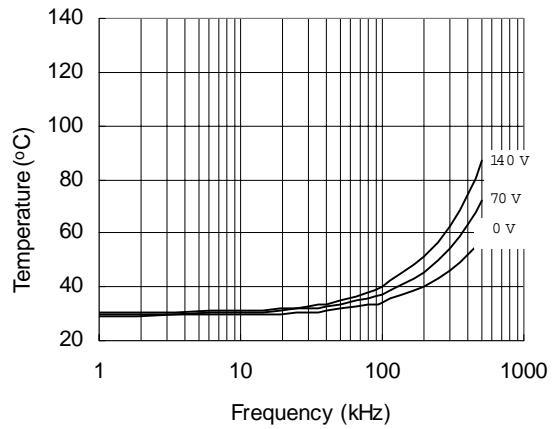


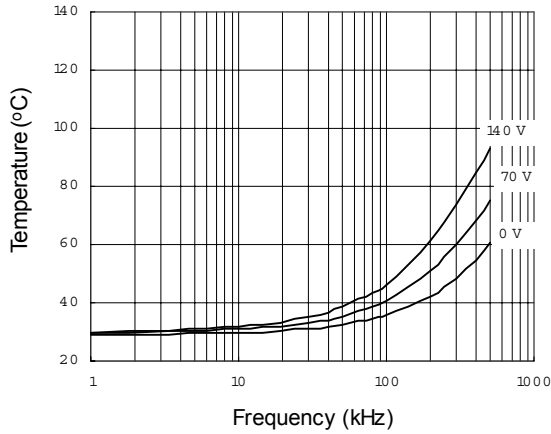
Figure 24. Maximum V_s Negative Offset vs. Supply Voltage



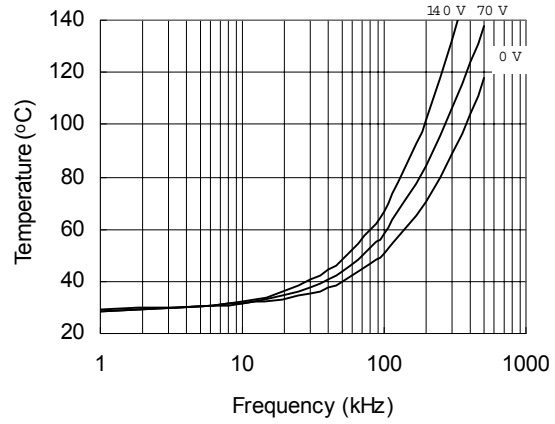
**Figure 25. IRS2108 vs. Frequency (IRFBC20),
 $R_{gate}=33\ \Omega$, $V_{cc}=15\ V$**



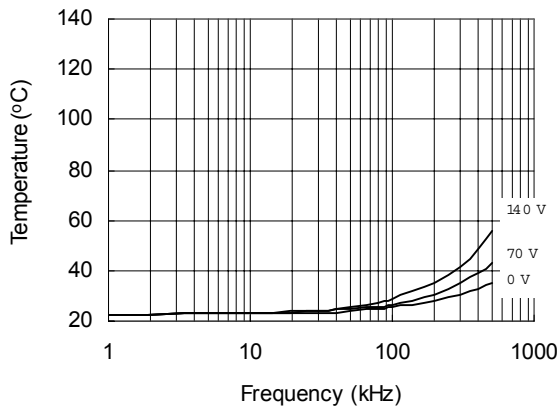
**Figure 26. IRS2108 vs. Frequency (IRFBC30),
 $R_{gate}=22\ \Omega$, $V_{cc}=15\ V$**



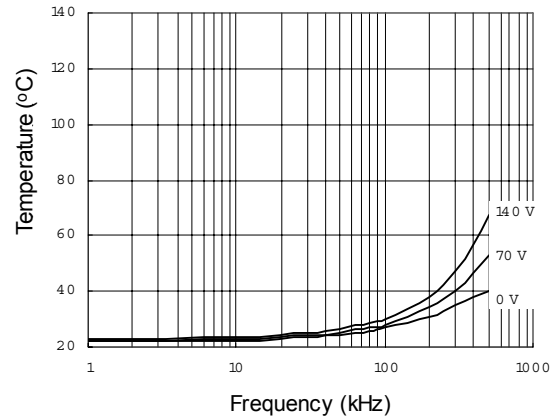
**Figure 27. IRS2108 vs. Frequency (IRFBC40),
 $R_{gate}=15 \Omega$, $V_{CC}=15 V$**



**Figure 28. IRS2108 vs. Frequency (IRFPE50),
 $R_{gate}=10 \Omega$, $V_{CC}=15 V$**

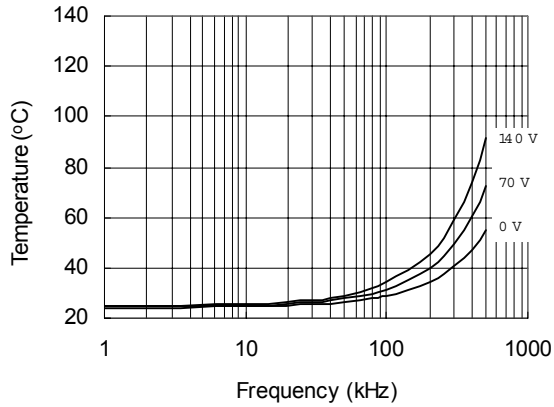


**Figure 29. IRS21084 vs. Frequency (IRFBC20),
 $R_{gate}=33 \Omega$, $V_{CC}=15 V$**

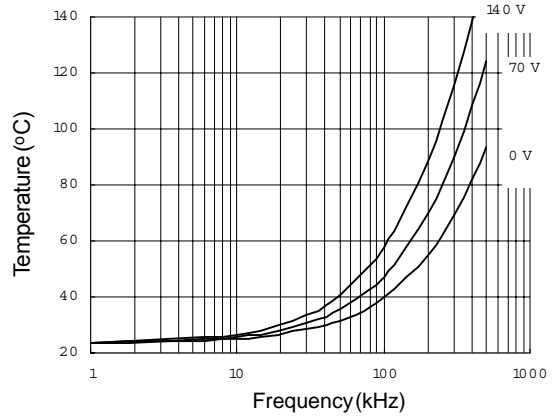


**Figure 30. IRS21084 vs. Frequency (IRFBC30),
 $R_{gate}=22 \Omega$, $V_{CC}=15 V$**

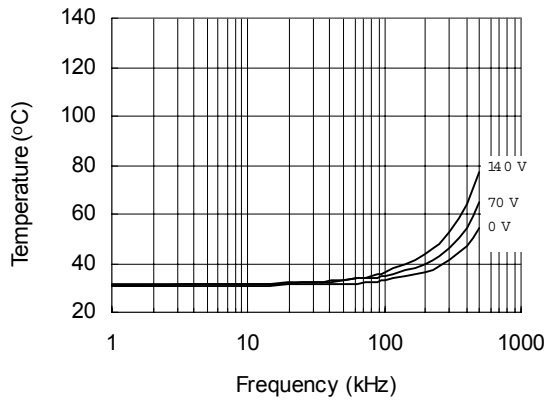
IRS2108/IRS21084(S)PbF



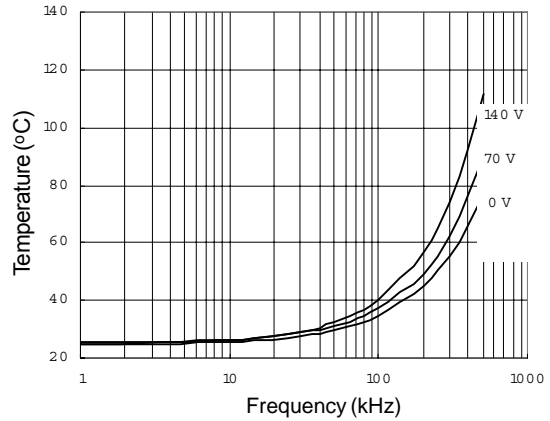
**Figure 31. IRS21084 vs. Frequency (IRFBC40),
 $R_{gate}=15 \Omega, V_{CC}=15 V$**



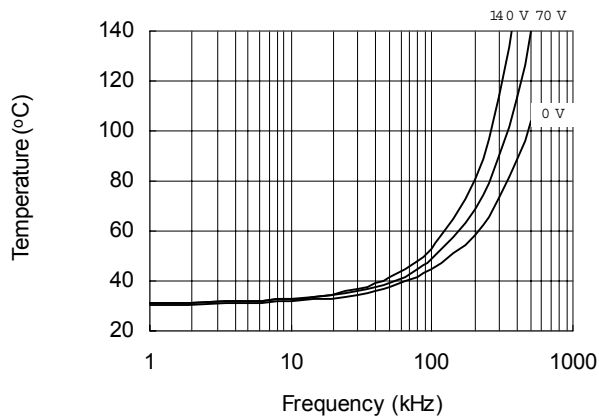
**Figure 32. IRS21084 vs. Frequency (IRFPE50),
 $R_{gate}=10 \Omega, V_{CC}=15 V$**



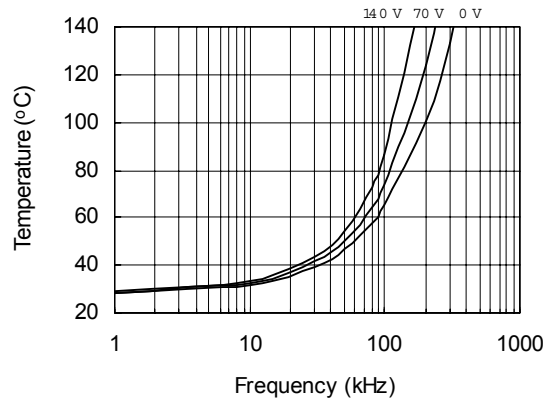
**Figure 33. IRS2108S vs. Frequency (IRFBC20),
 $R_{gate}=33 \Omega, V_{CC}=15 V$**



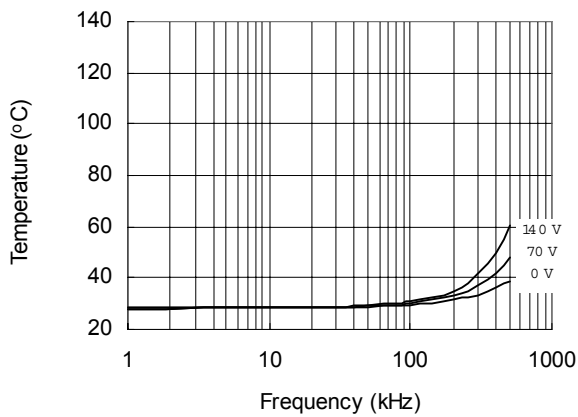
**Figure 34. IRS2108S vs. Frequency (IRFBC30),
 $R_{gate}=22 \Omega, V_{CC}=15 V$**



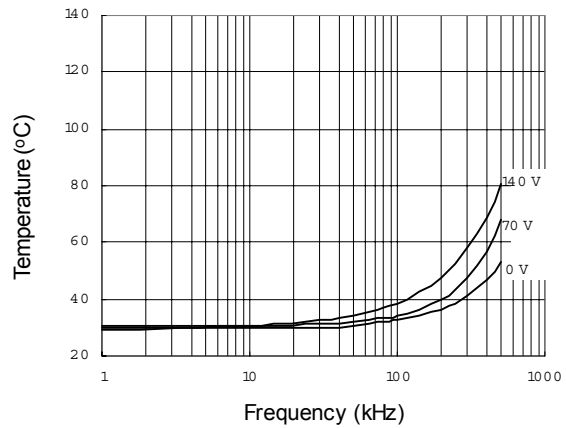
**Figure 35. IRS2108S vs. Frequency (IRFBC40),
 $R_{gate}=15 \Omega$, $V_{CC}=15 V$**



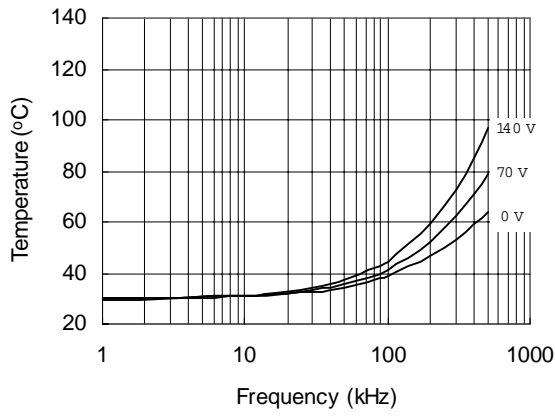
**Figure 36. IRS2108S vs. Frequency (IRFPE50),
 $R_{gate}=10 \Omega$, $V_{CC}=15 V$**



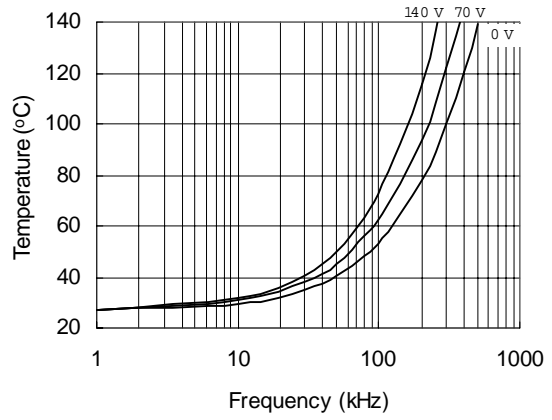
**Figure 37. IRS21084S vs. Frequency (IRFBC20),
 $R_{gate}=33 \Omega$, $V_{CC}=15 V$**



**Figure 38. IRS21084S vs. Frequency (IRFBC30),
 $R_{gate}=22 \Omega$, $V_{CC}=15 V$**

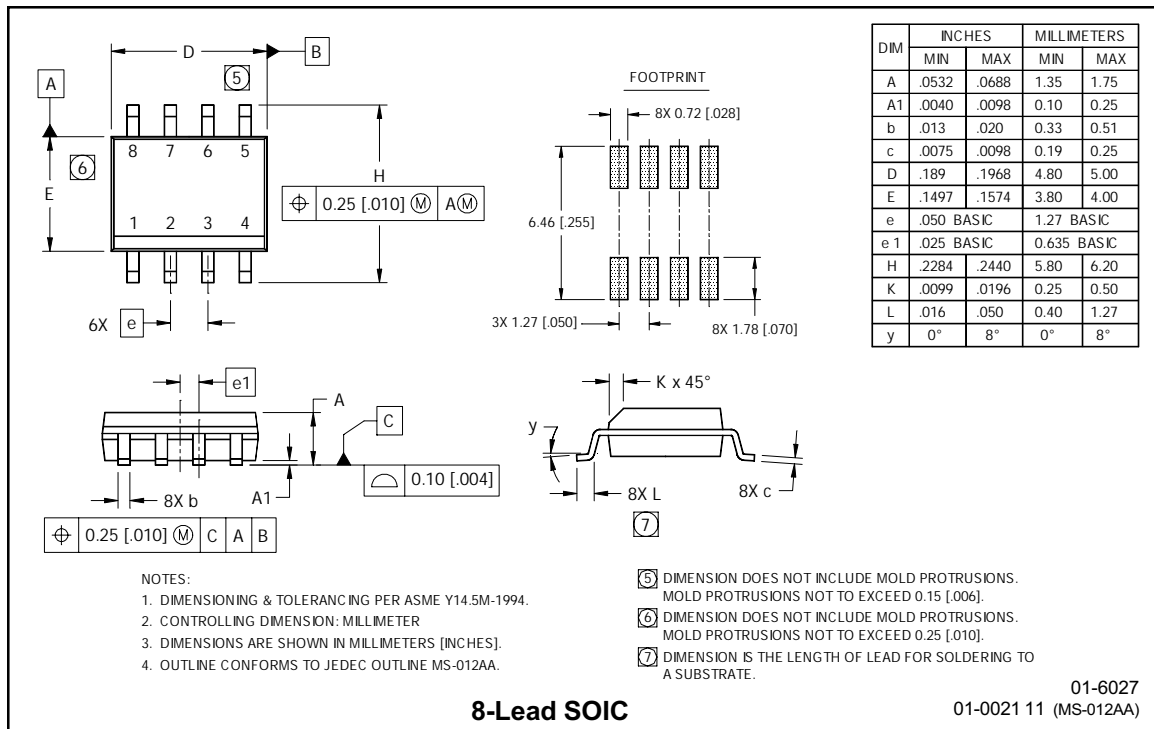
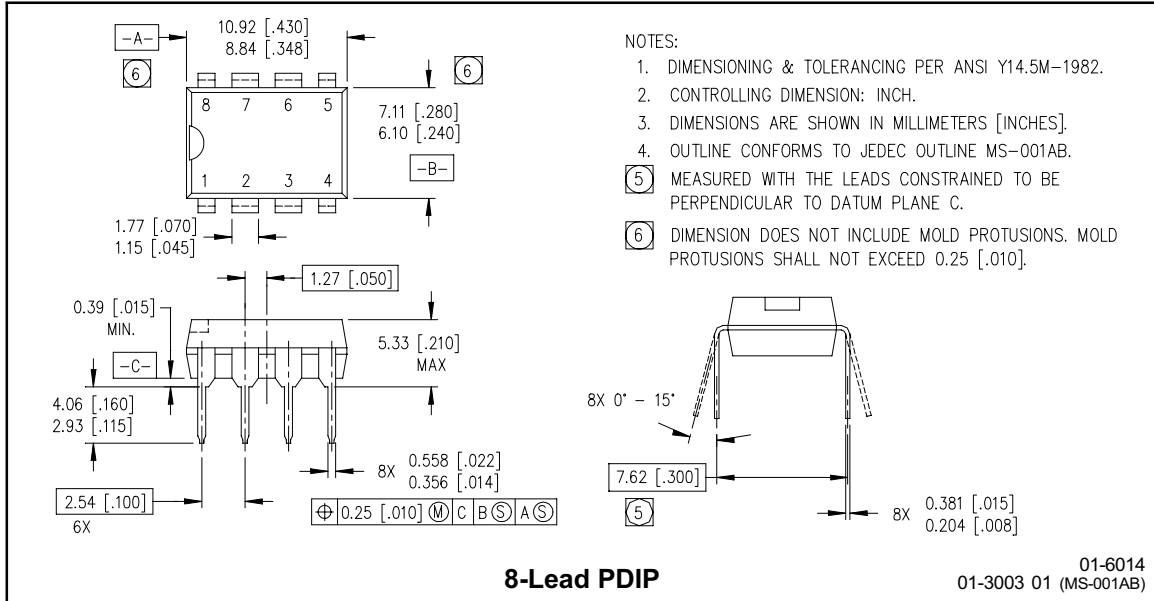


**Figure 39. IRS21084S vs. Frequency (IRFBC40),
 $R_{gate}=15 \Omega$, $V_{CC}=15 V$**

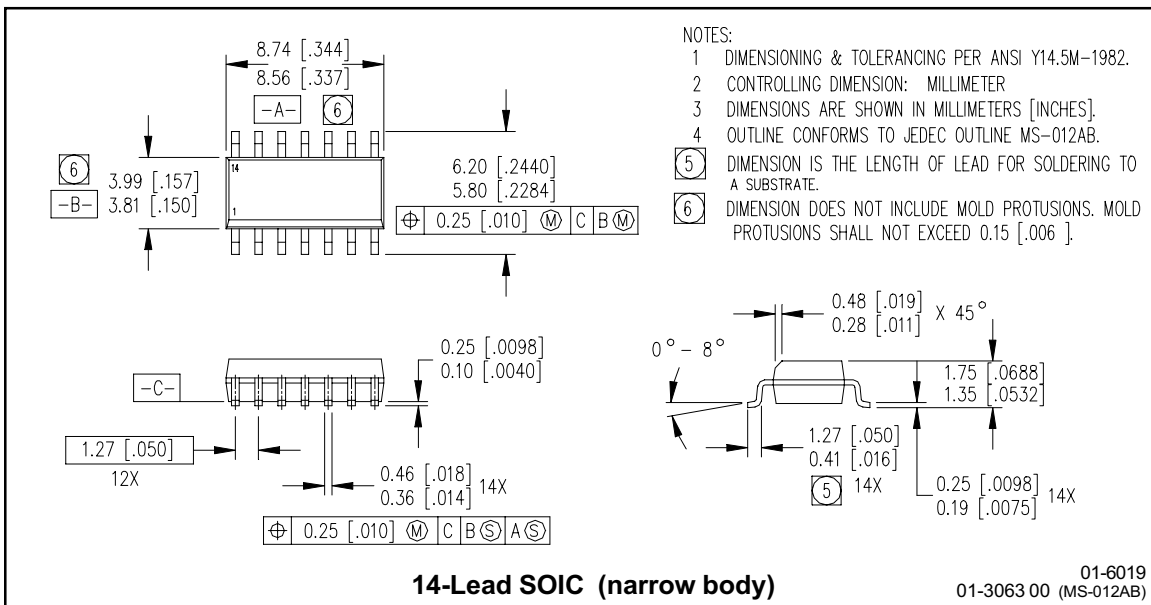
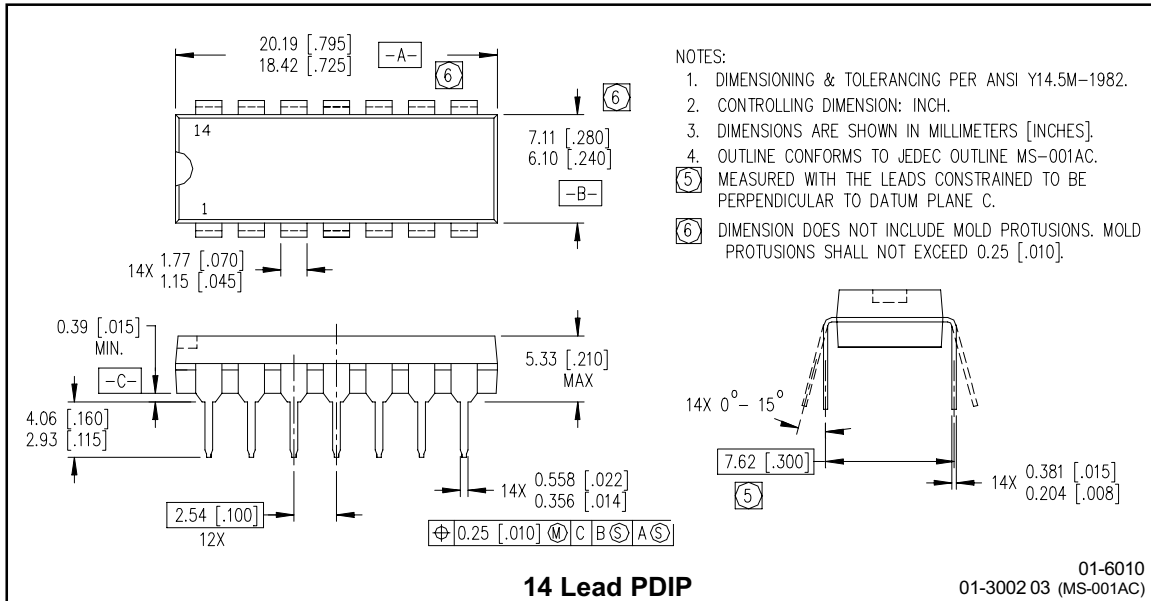


**Figure 40. IRS21084S vs. Frequency (IRFPE50),
 $R_{gate}=10 \Omega$, $V_{CC}=15 V$**

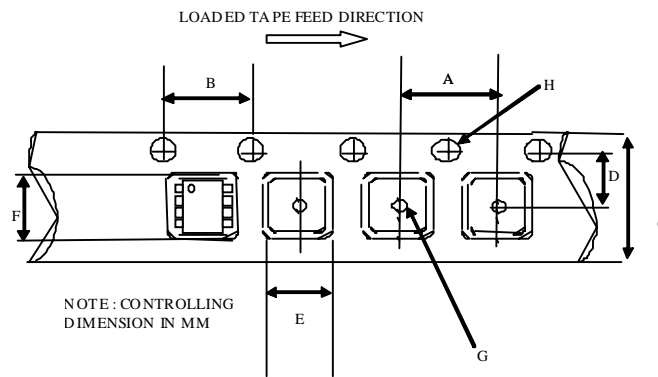
Case outlines



IRS2108/IRS21084(S)PbF

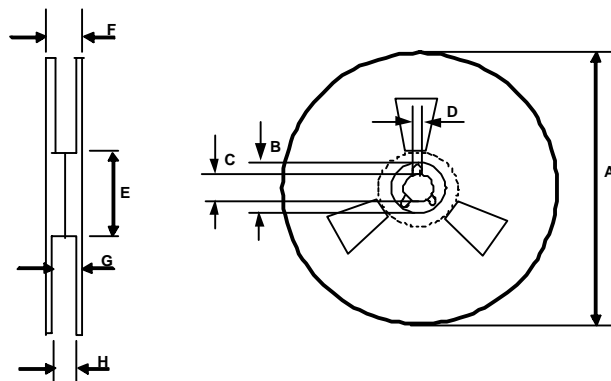


Tape & Reel 8-lead SOIC



CARRIER TAPE DIMENSION FOR 8SOICN

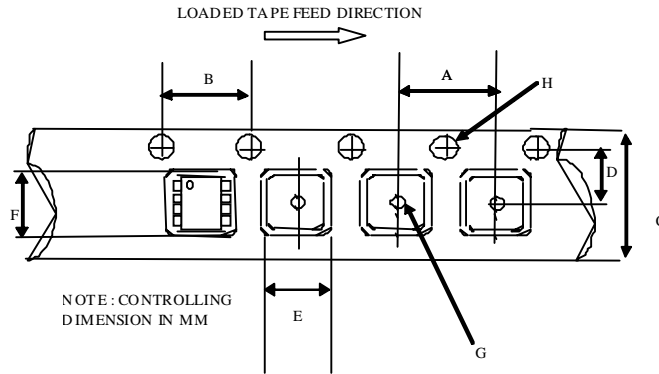
Code	Metric		Imperial	
	Min	Max	Min	Max
A	7.90	8.10	0.311	0.318
B	3.90	4.10	0.153	0.161
C	11.70	12.30	0.46	0.484
D	5.45	5.55	0.214	0.218
E	6.30	6.50	0.248	0.255
F	5.10	5.30	0.200	0.208
G	1.50	n/a	0.059	n/a
H	1.50	1.60	0.059	0.062



REEL DIMENSIONS FOR 8SOICN

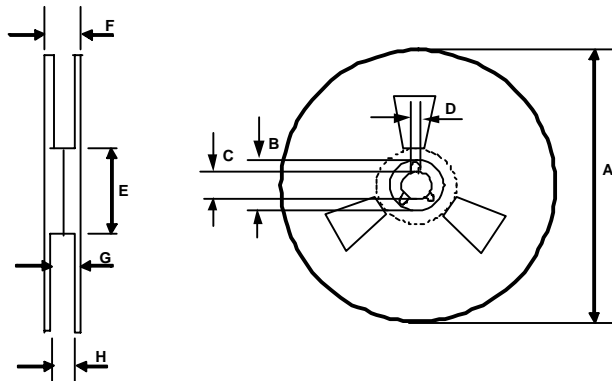
Code	Metric		Imperial	
	Min	Max	Min	Max
A	329.60	330.25	12.976	13.001
B	20.95	21.45	0.824	0.844
C	12.80	13.20	0.503	0.519
D	1.95	2.45	0.767	0.096
E	98.00	102.00	3.858	4.015
F	n/a	18.40	n/a	0.724
G	14.50	17.10	0.570	0.673
H	12.40	14.40	0.488	0.566

Tape & Reel 14-lead SOIC



CARRIER TAPE DIMENSION FOR 14SOICN

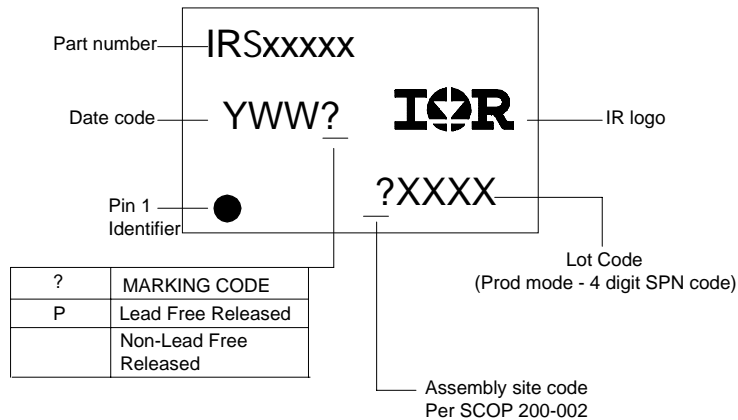
Code	Metric		Imperial	
	Min	Max	Min	Max
A	7.90	8.10	0.311	0.318
B	3.90	4.10	0.153	0.161
C	15.70	16.30	0.618	0.641
D	7.40	7.60	0.291	0.299
E	6.40	6.60	0.252	0.260
F	9.40	9.60	0.370	0.378
G	1.50	n/a	0.059	n/a
H	1.50	1.60	0.059	0.062



REEL DIMENSIONS FOR 14SOICN

Code	Metric		Imperial	
	Min	Max	Min	Max
A	329.60	330.25	12.976	13.001
B	20.95	21.45	0.824	0.844
C	12.80	13.20	0.503	0.519
D	1.95	2.45	0.767	0.096
E	98.00	102.00	3.858	4.015
F	n/a	22.40	n/a	0.881
G	18.50	21.10	0.728	0.830
H	16.40	18.40	0.645	0.724

LEADFREE PART MARKING INFORMATION



ORDER INFORMATION

- | | |
|---------------------------------------|---|
| 8-Lead PDIP IRS2108PbF | 14-Lead PDIP IRS21084PbF |
| 8-Lead SOIC IRS2108SPbF | 14-Lead SOIC IRS21084SPbF |
| 8-Lead SOIC Tape & Reel IRS2108STRPbF | 14-Lead SOIC Tape & Reel IRS21084STRPbF |