

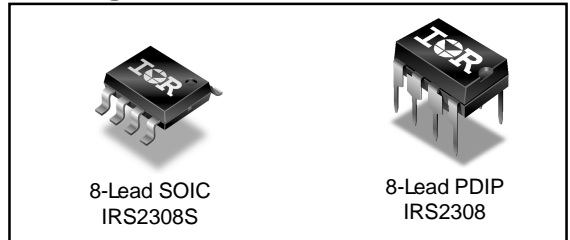
IRS2308(S)PbF

HALF-BRIDGE DRIVER

Features

- Floating channel designed for bootstrap operation
- Fully operational to +600 V
- Tolerant to negative transient voltage, dV/dt immune
- Gate drive supply range from 10 V to 20 V
- Undervoltage lockout for both channels
- 3.3 V, 5 V, and 15 V input logic compatible
- Cross-conduction prevention logic
- Matched propagation delay for both channels
- Outputs in phase with inputs
- Logic and power ground +/- 5 V offset.
- Internal 540 ns deadtime
- Lower di/dt gate driver for better noise immunity

Packages



Description

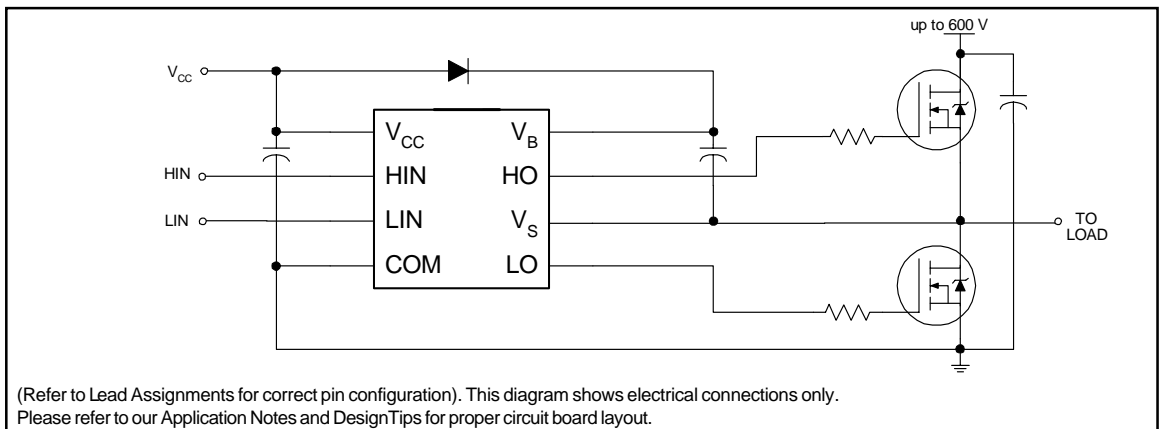
The IRS2308/IRS23084 are high voltage, high speed power MOSFET and IGBT drivers with dependent high and low side referenced output channels. Proprietary HVIC and latch immune CMOS technologies enable ruggedized monolithic construction. The logic input

is compatible with standard CMOS or LSTTL output, down to 3.3 V logic. The output drivers feature a high pulse current buffer stage designed for minimum driver cross-conduction. The floating channel can be used to drive an N-channel power MOSFET or IGBT in the high side configuration which operates up to 600 V.

Feature Comparison

| Part | Input logic | Cross-conduction prevention logic | Deadtime (ns) | Ground Pins | Ton/Toff (ns) |
|-------|-------------|-----------------------------------|-------------------------|----------------------|---------------|
| 2106 | HIN/LIN | no | none | COM | 220/200 |
| 21064 | | | | V _{ss} /COM | |
| 2108 | | | | COM | |
| 21084 | HIN/LIN | yes | Internal 540 | V _{ss} /COM | 220/200 |
| 2109 | IN/SD | yes | Programmable 540 - 5000 | COM | |
| 21094 | | | Internal 540 | V _{ss} /COM | 750/200 |
| 2304 | HIN/LIN | yes | Internal 100 | COM | 160/140 |
| 2308 | HIN/LIN | yes | Internal 540 | COM | 220/200 |

Typical Connection



Absolute Maximum Ratings

Absolute maximum ratings indicate sustained limits beyond which damage to the device may occur. All voltage parameters are absolute voltages referenced to COM. The thermal resistance and power dissipation ratings are measured under board mounted and still air conditions.

| Symbol | Definition | Min. | Max. | Units | |
|---------------------|---|-----------------------|-----------------------|-------|------|
| V _B | High side floating absolute voltage | -0.3 | 625 | V | |
| V _S | High side floating supply offset voltage | V _B - 25 | V _B + 0.3 | | |
| V _{HO} | High side floating output voltage | V _S - 0.3 | V _B + 0.3 | | |
| V _{CC} | Low side and logic fixed supply voltage | -0.3 | 25 | | |
| V _{LO} | Low side output voltage | -0.3 | V _{CC} + 0.3 | | |
| V _{IN} | Logic input voltage (HIN & LIN) | V _{SS} - 0.3 | V _{CC} + 0.3 | | |
| dV _S /dt | Allowable offset supply voltage transient | — | 50 | V/ns | |
| P _D | Package power dissipation @ T _A ≤ +25 °C | (8 lead PDIP) | — | 1.0 | W |
| | | (8 lead SOIC) | — | 0.625 | |
| R _{thJA} | Thermal resistance, junction to ambient | (8 lead PDIP) | — | 125 | °C/W |
| | | (8 lead SOIC) | — | 200 | |
| T _J | Junction temperature | — | 150 | °C | |
| T _S | Storage temperature | -50 | 150 | | |
| T _L | Lead temperature (soldering, 10 seconds) | — | 300 | | |

Recommended Operating Conditions

The input/output logic timing diagram is shown in Fig. 1. For proper operation the device should be used within the recommended conditions. The V_S and V_{SS} offset rating are tested with all supplies biased at a 15 V differential.

| Symbol | Definition | Min. | Max. | Units |
|-----------------|--|---------------------|---------------------|-------|
| V _B | High side floating supply absolute voltage | V _S + 10 | V _S + 20 | V |
| V _S | High side floating supply offset voltage | Note 1 | 600 | |
| V _{HO} | High side floating output voltage | V _S | V _B | |
| V _{CC} | Low side and logic fixed supply voltage | 10 | 20 | |
| V _{LO} | Low side output voltage | 0 | V _{CC} | |
| V _{IN} | Logic input voltage | COM | V _{CC} | |
| T _A | Ambient temperature | -40 | 125 | °C |

Note 1: Logic operational for V_S of -5 V to +600 V. Logic state held for V_S of -5 V to -V_{BS}. (Please refer to the Design Tip DT97-3 for more details).

Dynamic Electrical Characteristics

V_{BIAS} (V_{CC} , V_{BS}) = 15 V, V_{SS} = COM, C_L = 1000 pF, T_A = 25 °C, DT = V_{SS} unless otherwise specified.

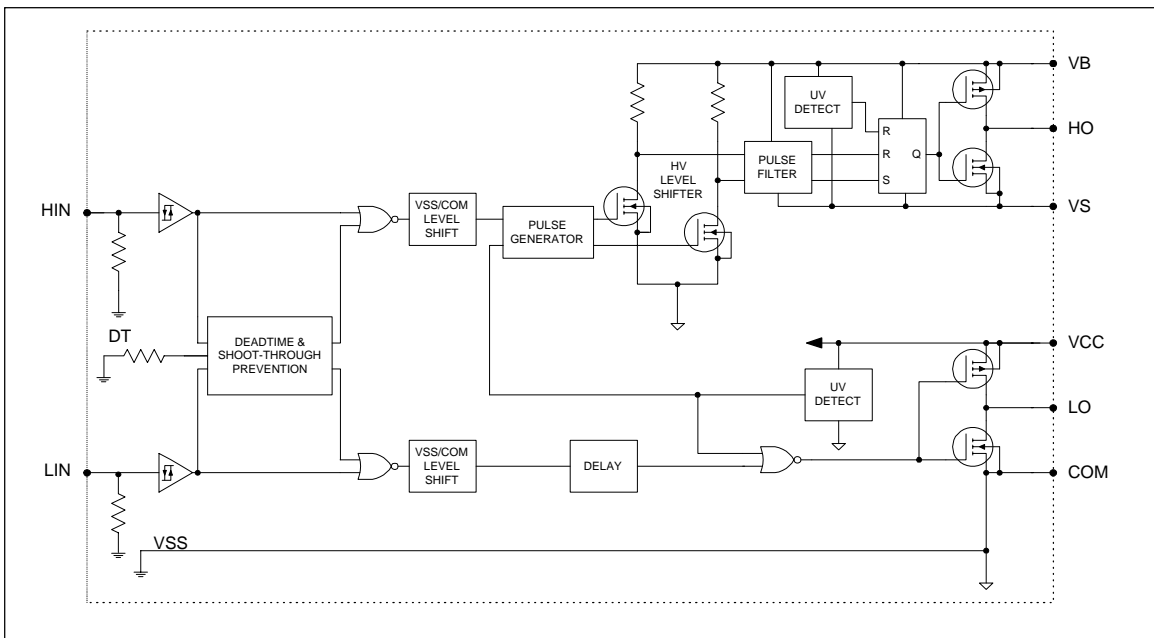
| Symbol | Definition | Min. | Typ. | Max. | Units | Test Conditions |
|-----------|--|------|------|------|-------|----------------------|
| t_{on} | Turn-on propagation delay | — | 220 | 300 | ns | $V_S = 0$ V |
| t_{off} | Turn-off propagation delay | — | 200 | 280 | | $V_S = 0$ V or 600 V |
| MT | Delay matching $ t_{on} - t_{off} $ | — | 0 | 46 | | |
| t_r | Turn-on rise time | — | 100 | 220 | | $V_S = 0$ V |
| t_f | Turn-off fall time | — | 35 | 80 | | |
| DT | Deadtime: LO turn-off to HO turn-on(DT _{LO-HO}) & HO turn-off to LO turn-on (DT _{HO-LO}) | 400 | 540 | 680 | | |
| MDT | Deadtime matching = $ DT_{LO-HO} - DT_{HO-LO} $ | — | 0 | 60 | | |

Static Electrical Characteristics

V_{BIAS} (V_{CC} , V_{BS}) = 15 V, V_{SS} = COM, DT = V_{SS} and T_A = 25 °C unless otherwise specified. The V_{IL} , V_{IH} , and I_{IN} parameters are referenced to V_{SS}/COM and are applicable to the respective input leads: HIN and LIN. The V_O , I_O , and R_{on} parameters are referenced to COM and are applicable to the respective output leads: HO and LO.

| Symbol | Definition | Min. | Typ. | Max. | Units | Test Conditions |
|----------------------------|--|------|------|------|---------|---|
| V_{IH} | Logic "1" input voltage for HIN & LIN | 2.5 | — | — | V | $V_{CC} = 10$ V to 20 V $I_O = 2$ mA |
| V_{IL} | Logic "0" input voltage for HIN & LIN | — | — | 0.8 | | |
| V_{OH} | High level output voltage, $V_{BIAS} - V_O$ | — | 0.05 | 0.2 | | |
| V_{OL} | Low level output voltage, V_O | — | 0.02 | 0.1 | | |
| I_{LK} | Offset supply leakage current | — | — | 50 | μ A | $V_B = V_S = 600$ V |
| I_{QBS} | Quiescent V_{BS} supply current | 20 | 60 | 150 | μ A | $V_{IN} = 0$ V or 5 V |
| I_{QCC} | Quiescent V_{CC} supply current | 0.4 | 1.0 | 1.6 | mA | |
| I_{IN+} | Logic "1" input bias current | — | 5 | 20 | μ A | $HIN = 5$ V, $LIN = 5$ V |
| I_{IN-} | Logic "0" input bias current | — | 1 | 2 | | $HIN = 0$ V, $LIN = 0$ V |
| V_{CCUV+} V_{BSUV+} | V_{CC} and V_{BS} supply undervoltage positive going threshold | 8.0 | 8.9 | 9.8 | V | |
| V_{CCUV-} V_{BSUV-} | V_{CC} and V_{BS} supply undervoltage negative going threshold | 7.4 | 8.2 | 9.0 | | |
| V_{CCUVH} V_{BSUVH} | Hysteresis | 0.3 | 0.7 | — | | |
| I_{O+} | Output high short circuit pulsed current | 97 | 290 | — | mA | $V_O = 0$ V, $PW \leq 10$ μ s |
| I_{O-} | Output low short circuit pulsed current | 250 | 600 | — | | $V_O = 15$ V, $PW \leq 10$ μ s |

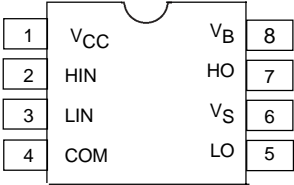
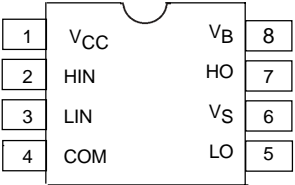
Functional Block Diagram



Lead Definitions

| Symbol | Description |
|-----------------|---|
| HIN | Logic input for high side gate driver output (HO), in phase |
| LIN | Logic input for low side gate driver output (LO), in phase |
| V _B | High side floating supply |
| HO | High side gate driver output |
| V _S | High side floating supply return |
| V _{CC} | Low side and logic fixed supply |
| LO | Low side gate driver output |
| COM | Low side return |

Lead Assignments

| | |
|--|---|
|  <p>8 Lead PDIP</p> |  <p>8 Lead SOIC</p> |
| IRS2308PbF | IRS2308SPbF |

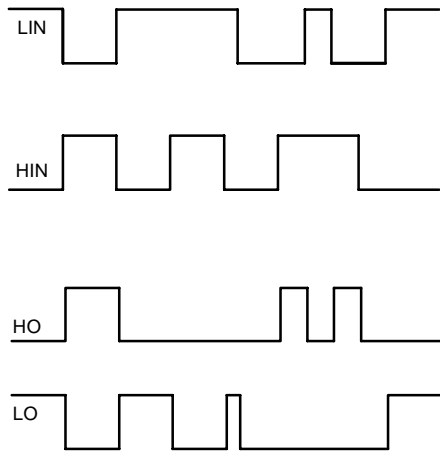


Figure 1. Input/Output Timing Diagram

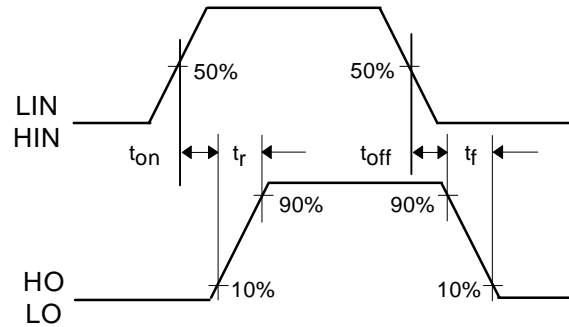


Figure 2. Switching Time Waveform Definitions

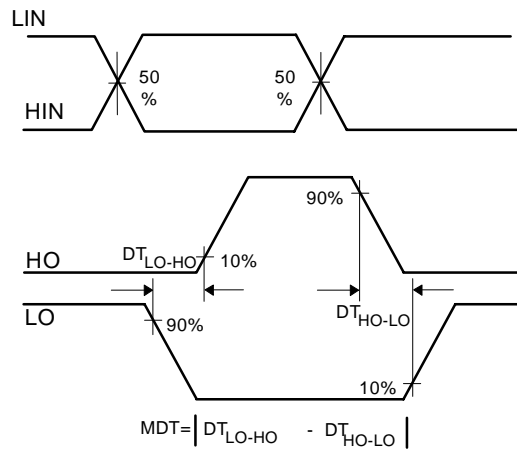


Figure 3. Deadtime Waveform Definitions

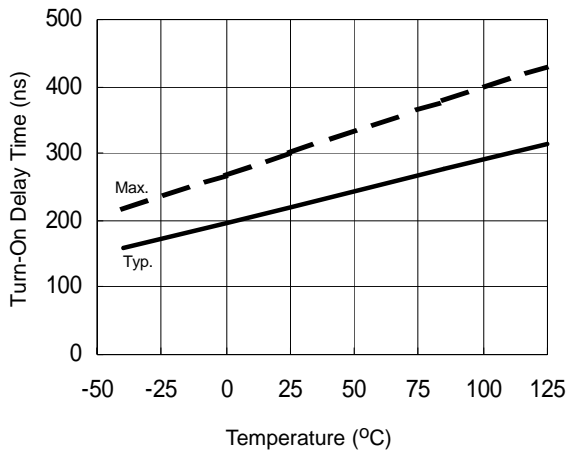


Figure 4A. Turn-On Time vs. Temperature

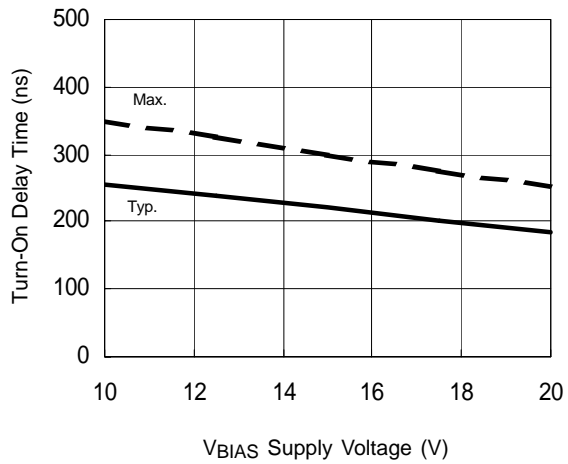


Figure 4B. Turn-On Time vs. Supply Voltage

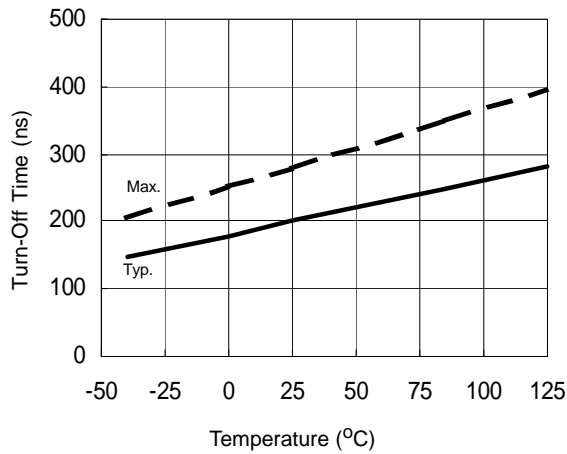


Figure 5A. Turn-Off Propagation Delay vs. Temperature

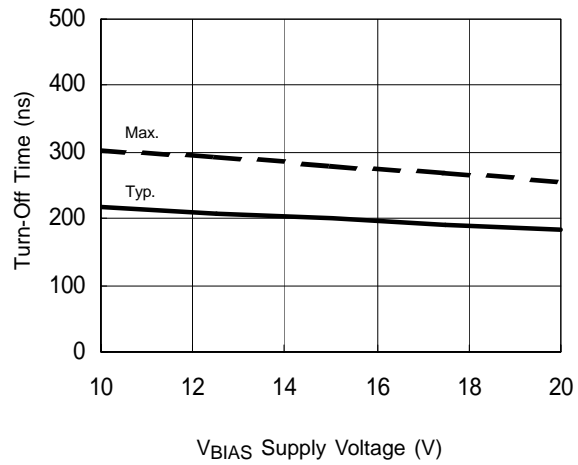


Figure 5B. Turn-Off Propagation Delay vs. Supply Voltage

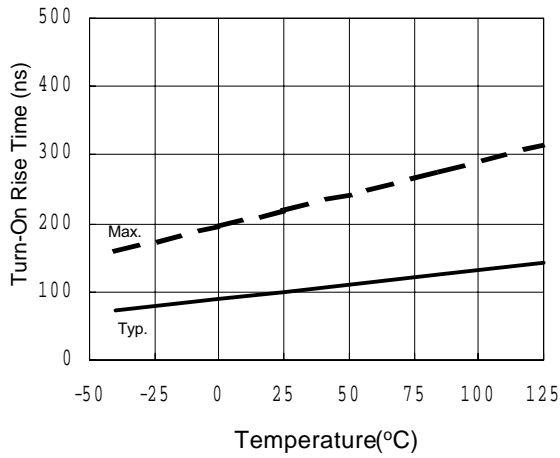


Figure 6A. Turn-On Rise Time vs. Temperature

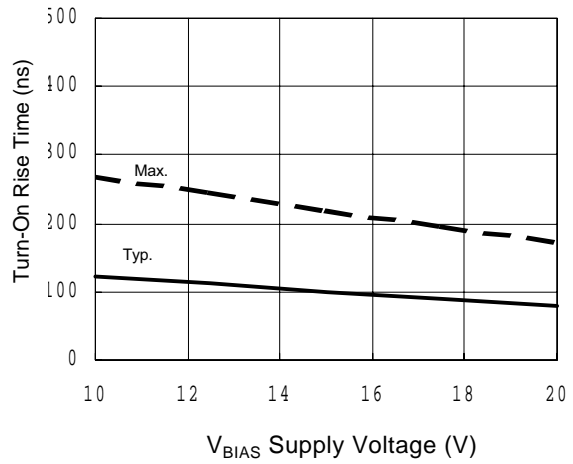


Figure 6B. Turn-On Rise Time vs. Supply Voltage

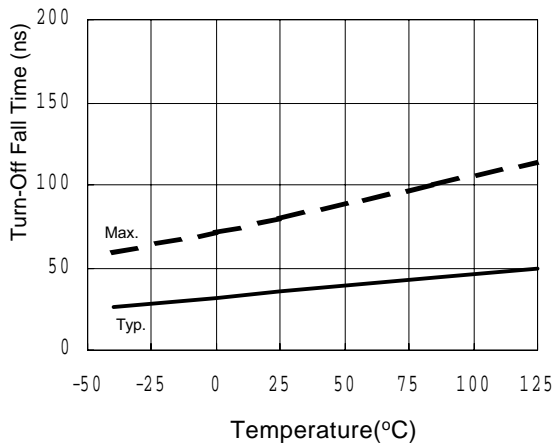


Figure 7A. Turn-Off Fall Time vs. Temperature

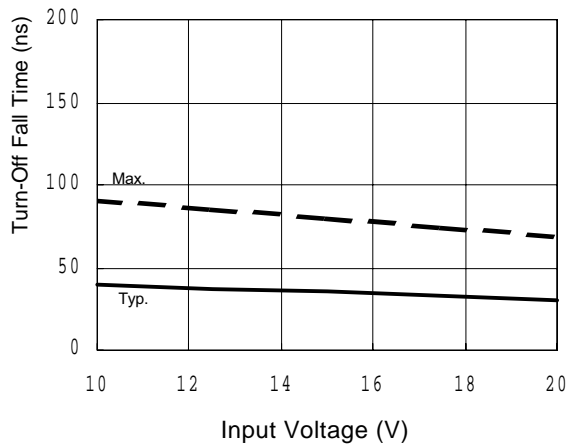


Figure 7B. Turn-Off Fall Time vs. Supply Voltage

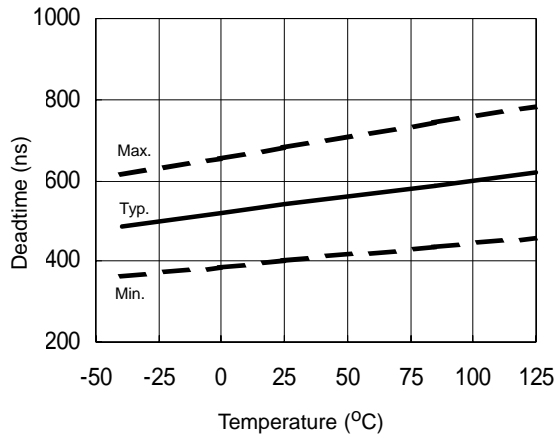


Figure 8A. Deadtime vs. Temperature

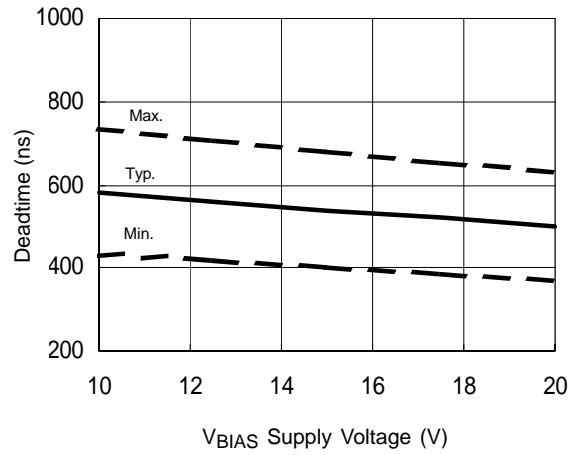


Figure 8A. Deadtime vs. Supply Voltage

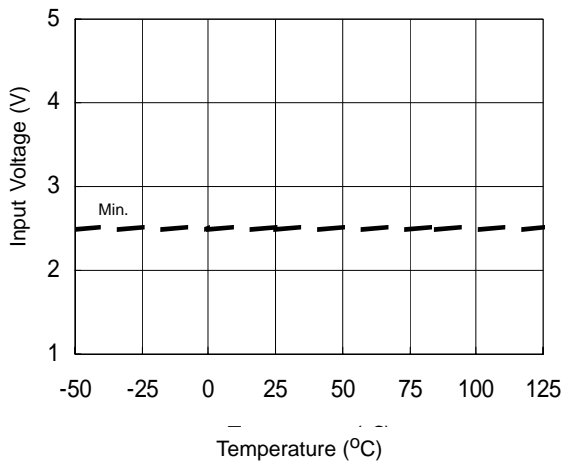


Figure 9A. Logic "1" Input Voltage vs. Temperature

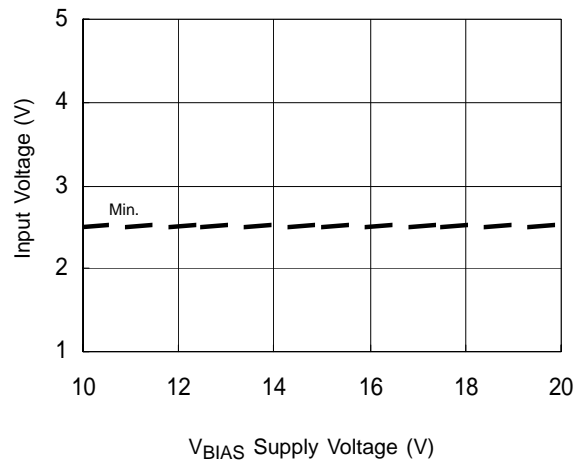


Figure 9B. Logic "1" Input Voltage vs. Supply Voltage

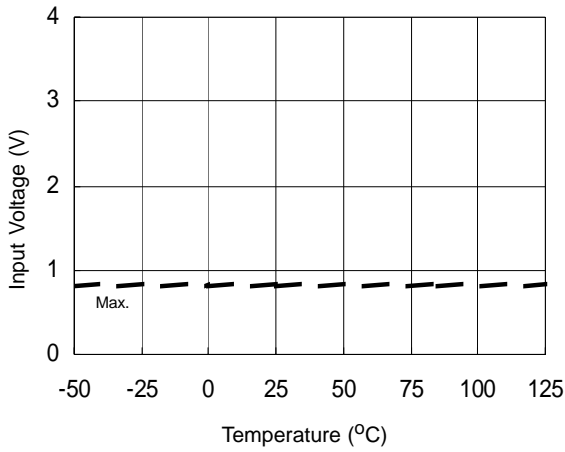


Figure 10A. Logic "0" Input Voltage vs. Temperature

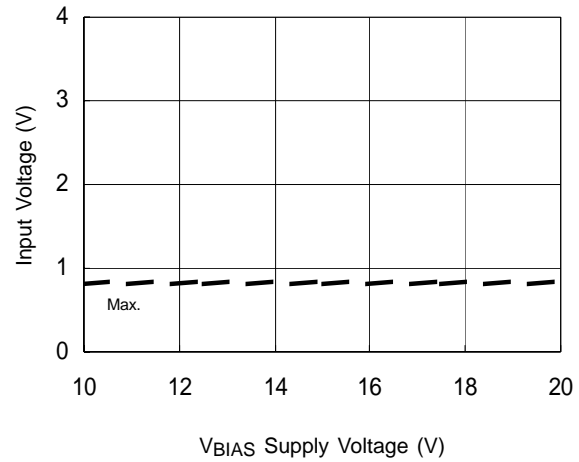


Figure 10A. Logic "0" Input Voltage vs. Supply Voltage

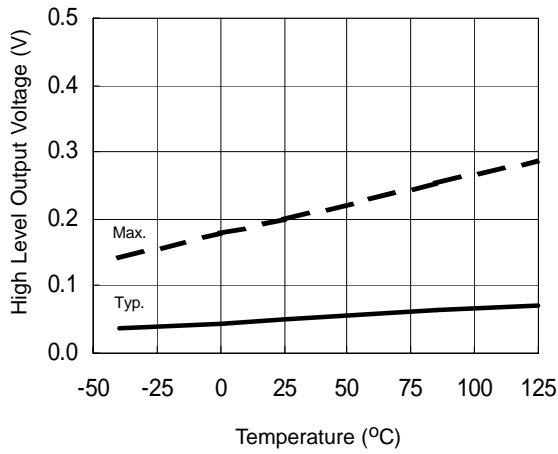


Figure 11A. High Level Output Voltage vs. Temperature

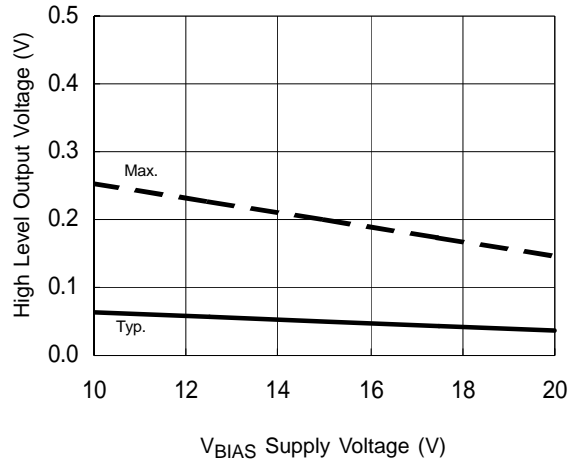


Figure 11A. High Level Output Voltage vs. Supply Voltage

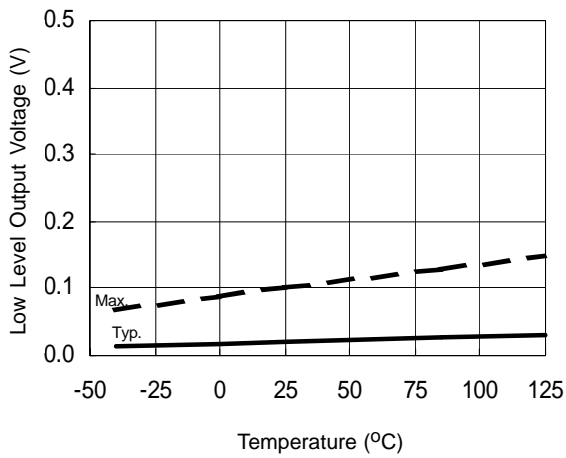


Figure 12A. Low Level Output Voltage vs. Temperature

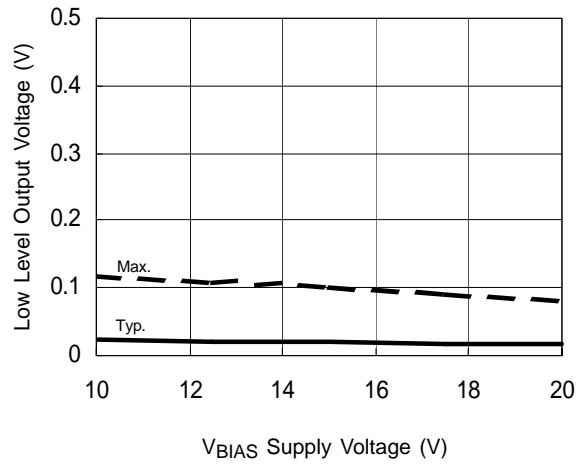


Figure 12B. Low Level Output Voltage vs. Supply Voltage

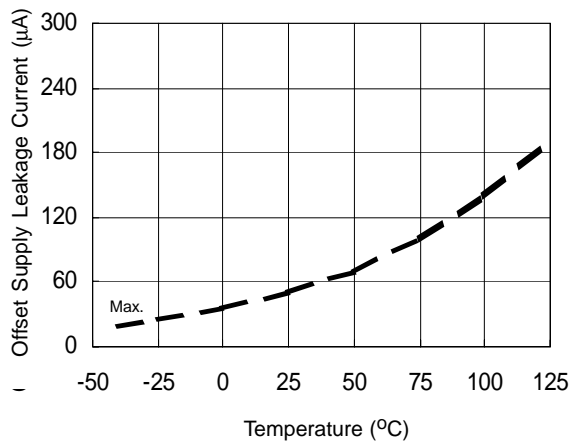


Figure 13A. Offset Supply Leakage Current vs. Temperature

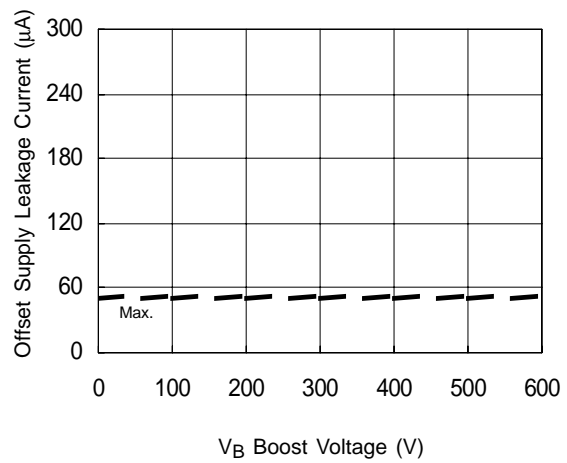


Figure 13B. Offset Supply Leakage Current vs. Supply Voltage

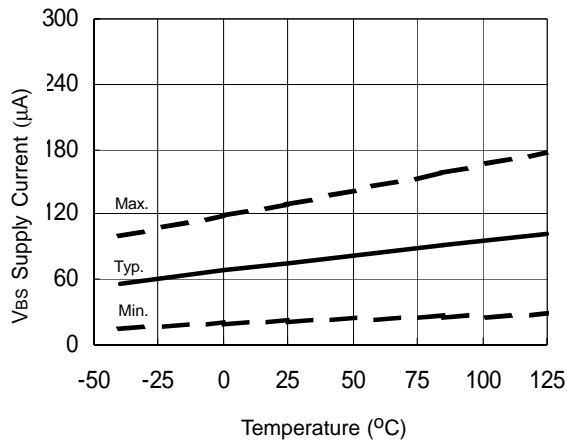


Figure 14A. V_{BS} Supply Current vs. Temperature

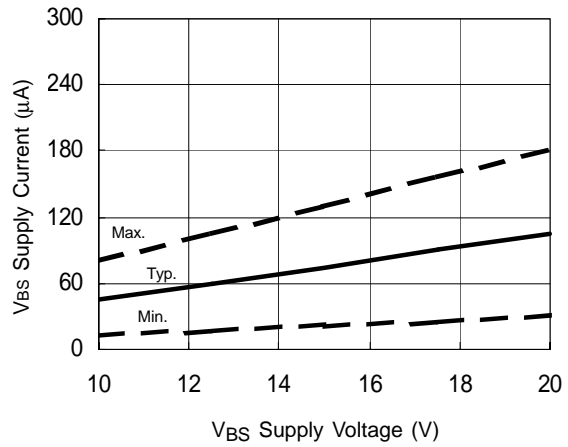


Figure 14B. V_{BS} Supply Current vs. Supply Voltage

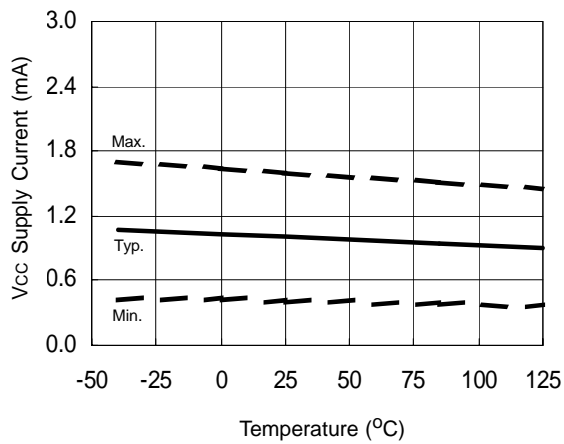


Figure 15A. V_{CC} Supply Current vs. Temperature

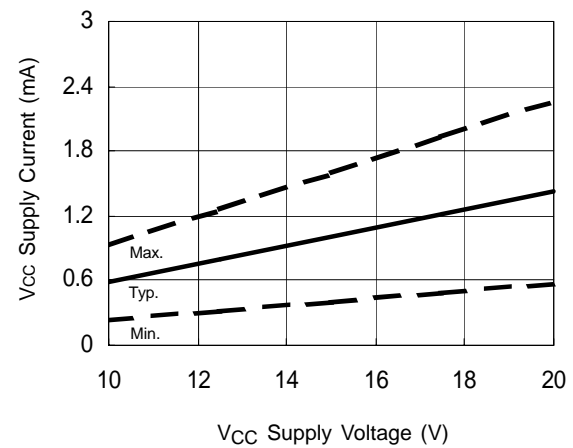


Figure 14B. V_{CC} Supply Current vs. Supply Voltage

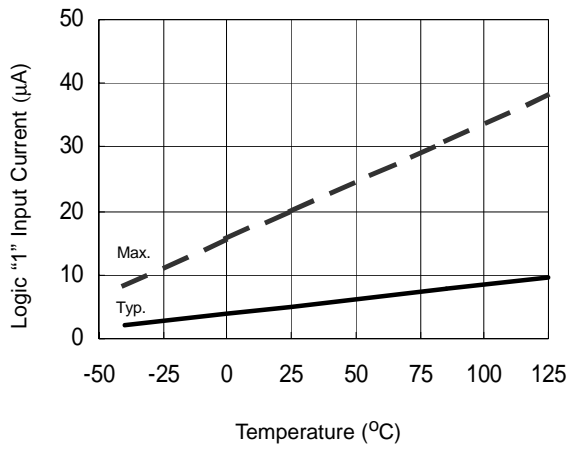


Figure 16A. Logic "1" Input Current vs. Temperature

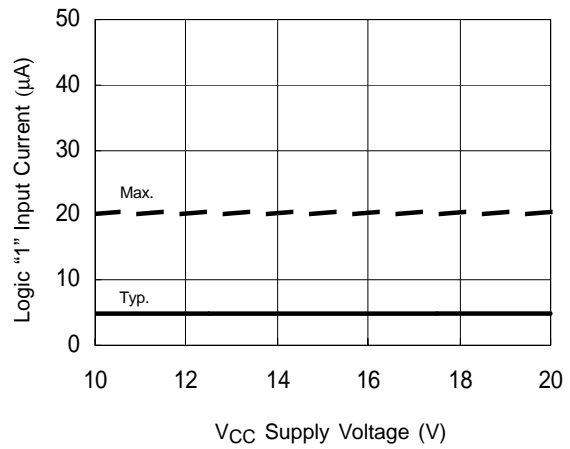


Figure 16B. Logic "1" Input Current vs. Supply Voltage

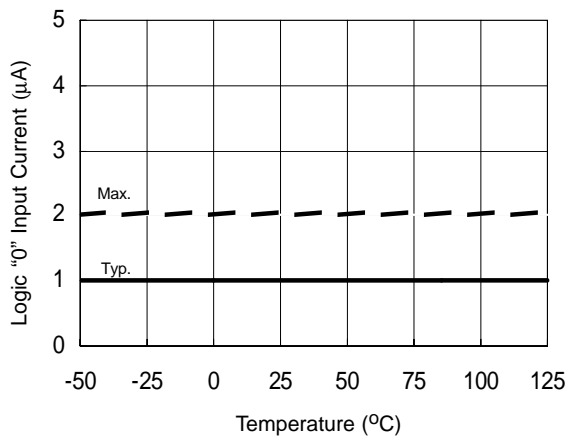


Figure 17A. Logic "0" Input Current vs. Temperature

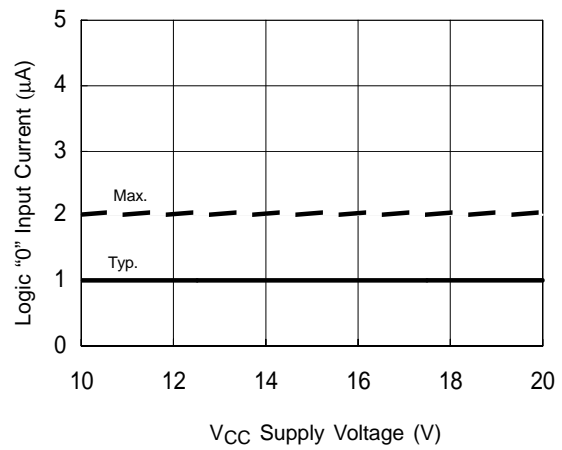


Figure 17B. Logic "0" Input Current vs. Supply Voltage

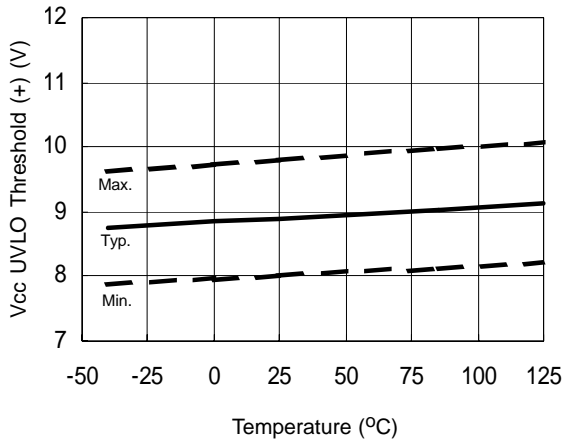


Figure 18. V_{CC} Undervoltage Threshold (+) vs. Temperature

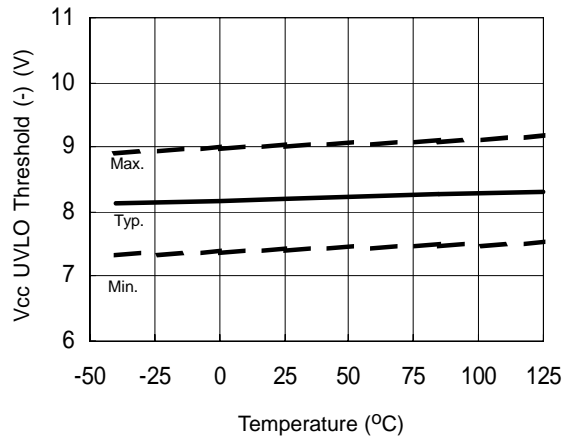


Figure 19. V_{CC} Undervoltage Threshold (-) vs. Temperature

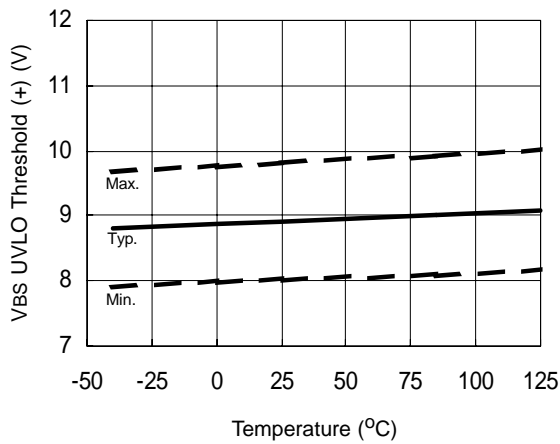


Figure 20. V_{BS} Undervoltage Threshold (+) vs. Temperature

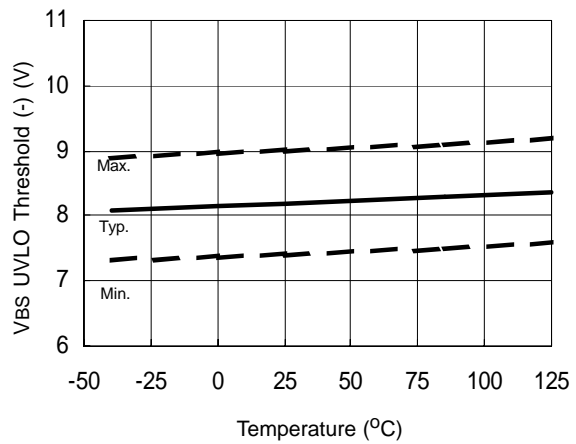


Figure 21. V_{BS} Undervoltage Threshold (-) vs. Temperature

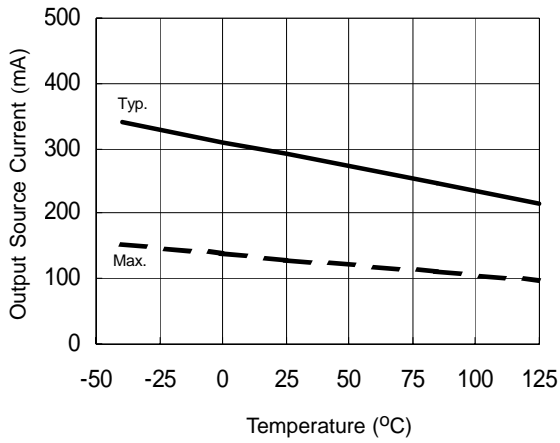


Figure 22A. Output Source Current vs. Temperature

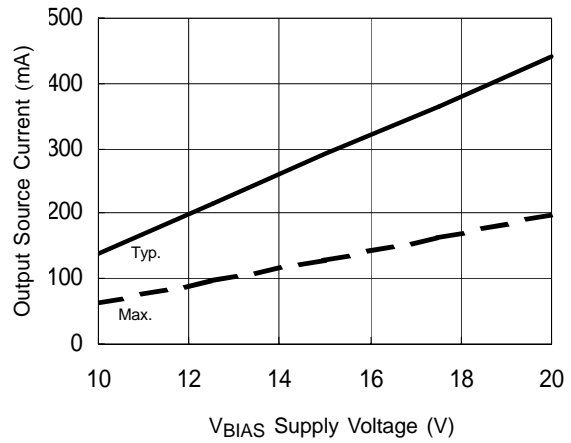


Figure 22B. Output Source Current vs. Supply Voltage

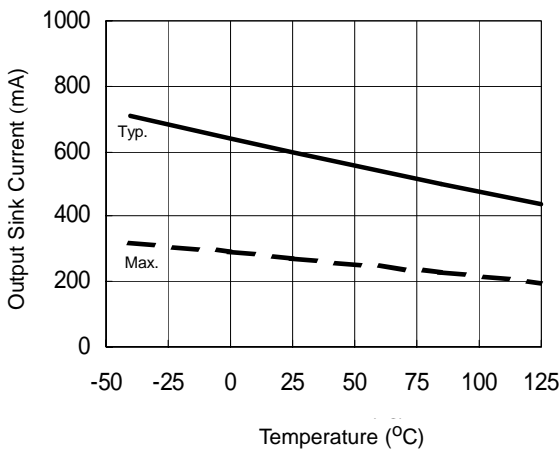


Figure 23A. Output Sink Current vs. Temperature

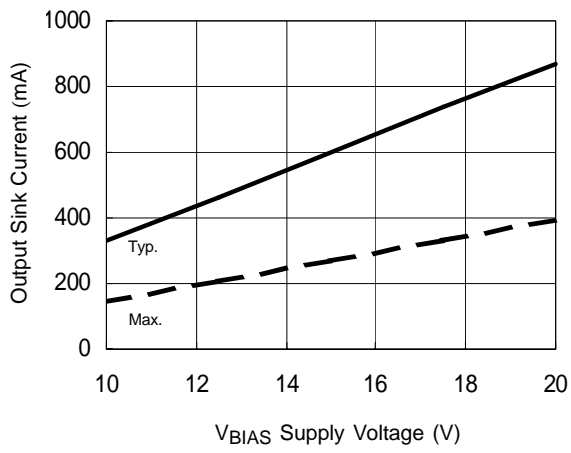


Figure 23B. Output Sink Current vs. Supply Voltage

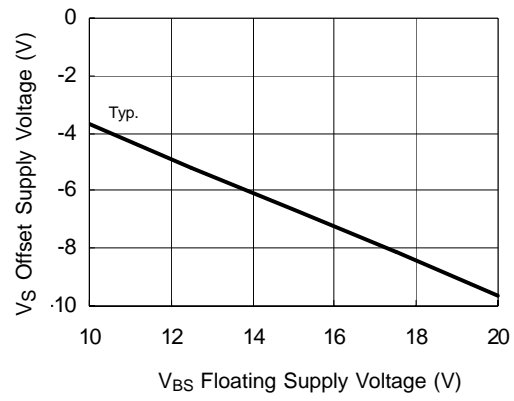


Figure 24. Maximum V_S Negative Offset vs. Supply Voltage

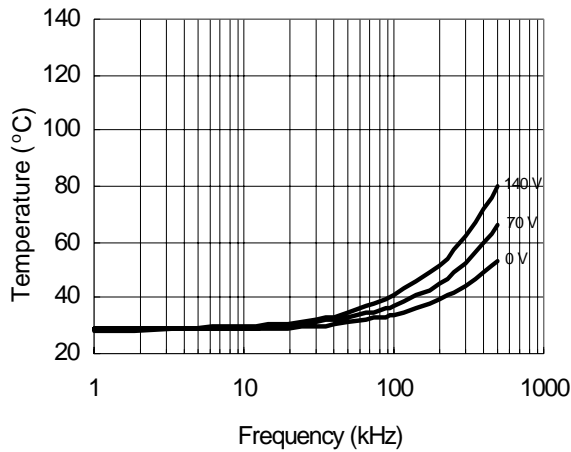


Figure 25. IRS2308 vs. Frequency (IRFBC20),
 $R_{gate}=33\Omega, V_{CC}=15\text{ V}$

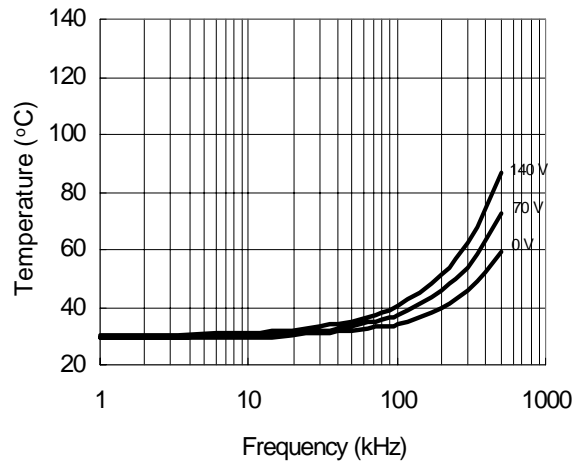


Figure 26. IRS2308 vs. Frequency (IRFBC30),
 $R_{gate}=22\Omega, V_{CC}=15\text{ V}$

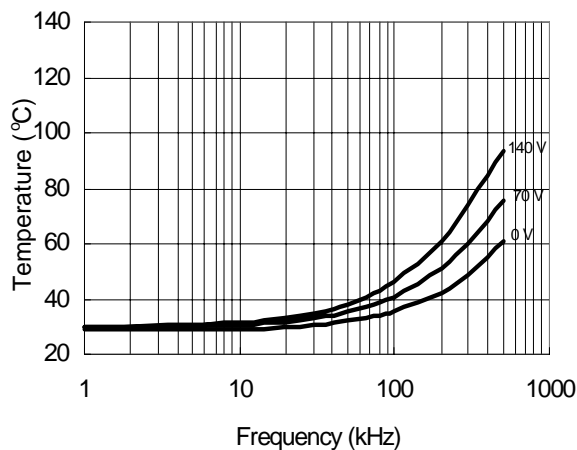


Figure 27. IRS2308 vs. Frequency (IRFBC40),
 $R_{gate}=15\Omega, V_{CC}=15\text{ V}$

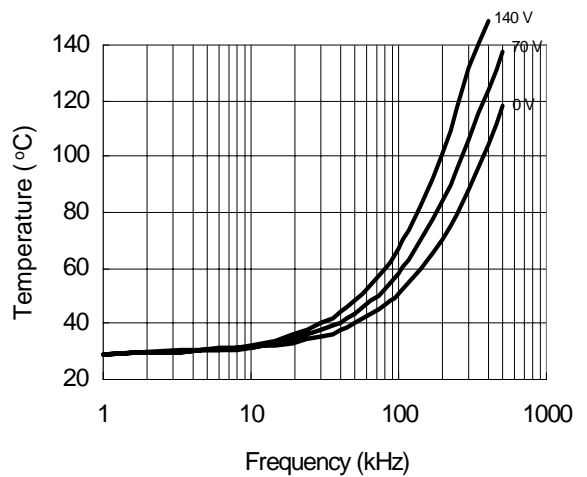
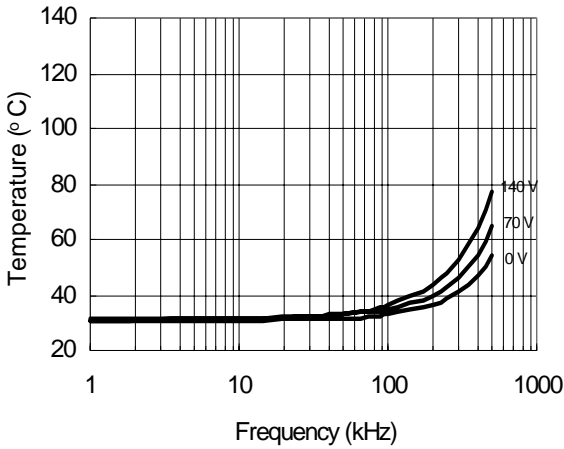
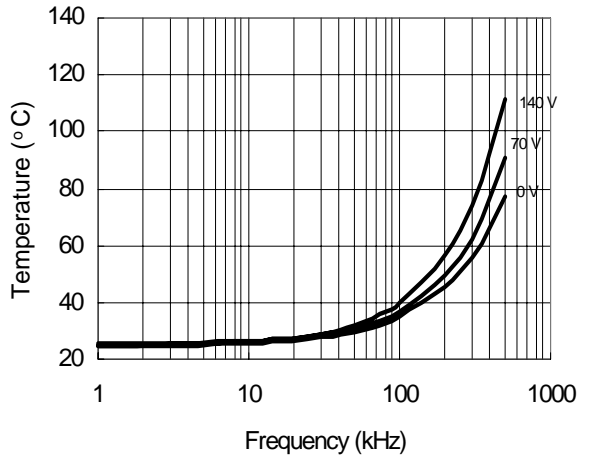


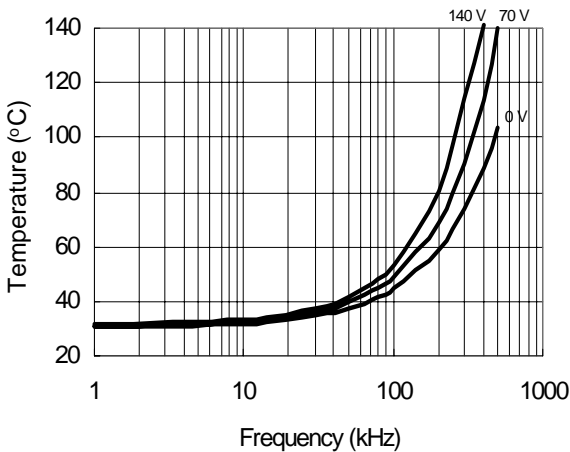
Figure 28. IRS2308 vs. Frequency (IRFPE50),
 $R_{gate}=10\Omega, V_{CC}=15\text{ V}$



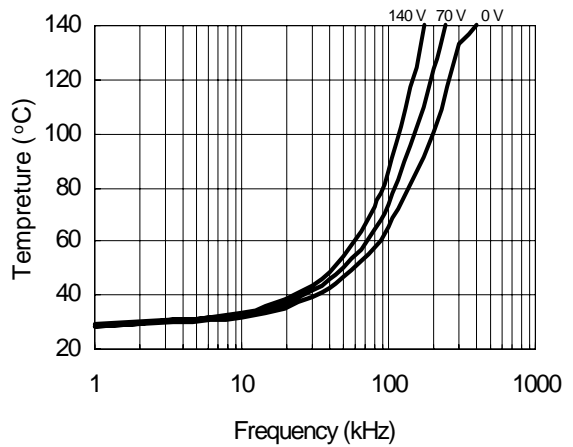
**Figure 29. IRS2308S vs. Frequency (IRFBC20),
 $R_{gate}=33\Omega$, $V_{CC}=15\text{ V}$**



**Figure 30. IRS2308S vs. Frequency (IRFBC30),
 $R_{gate}=22\Omega$, $V_{CC}=15\text{ V}$**

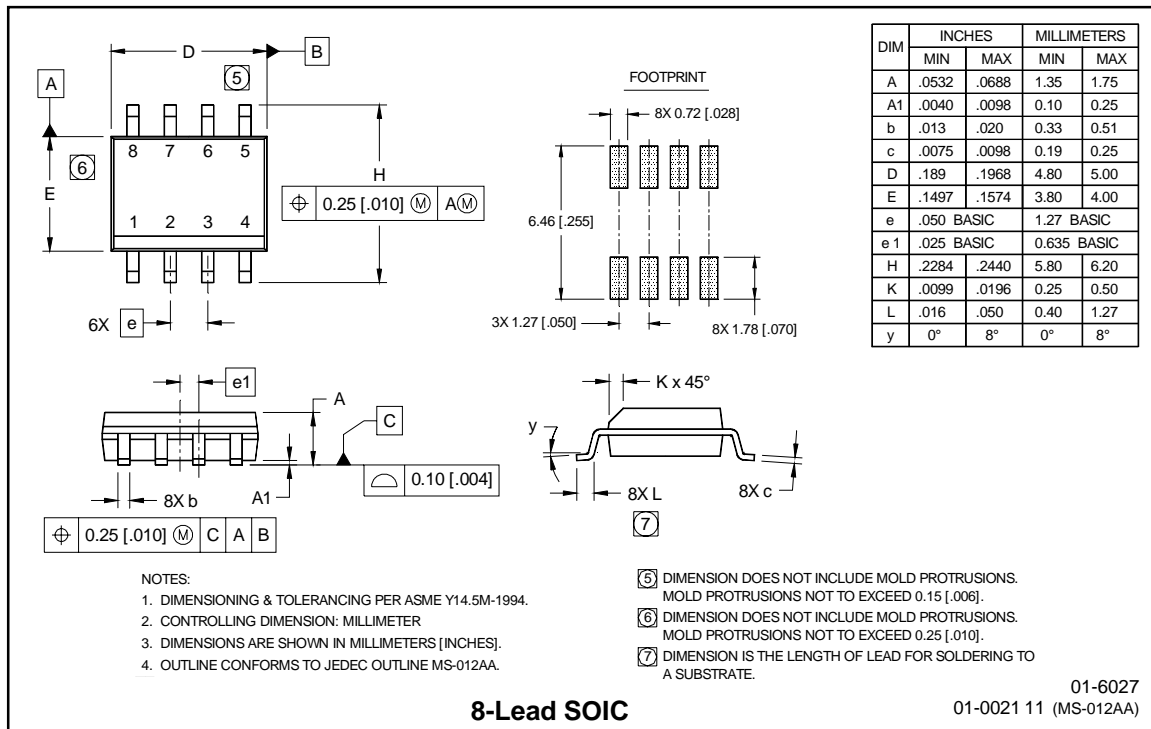
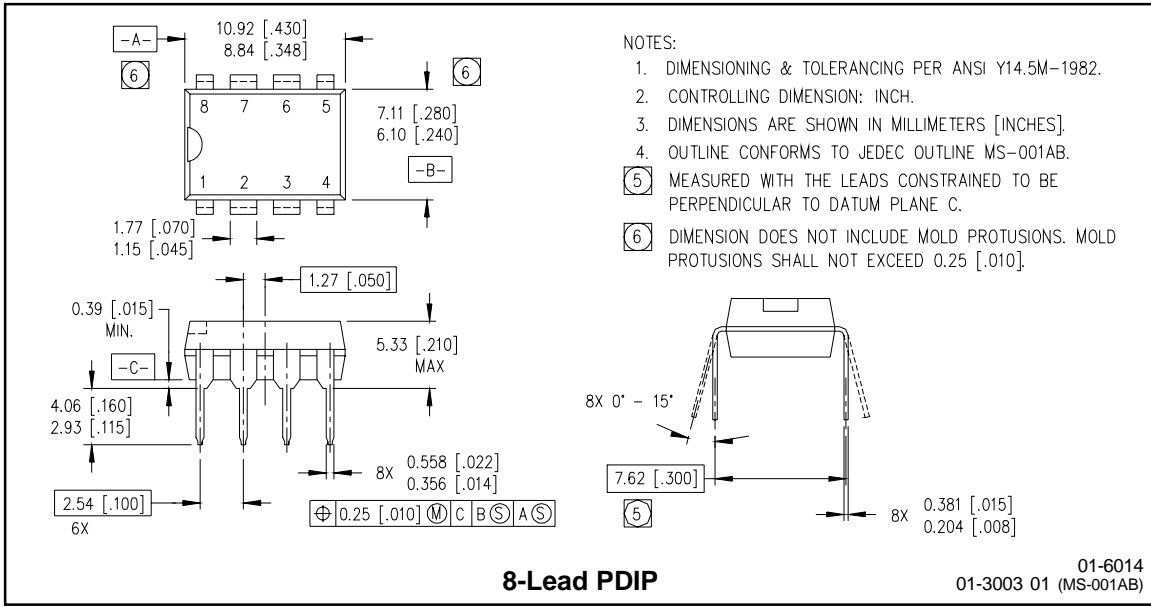


**Figure 31. IRS2308S vs. Frequency (IRFBC40),
 $R_{gate}=15\Omega$, $V_{CC}=15\text{ V}$**

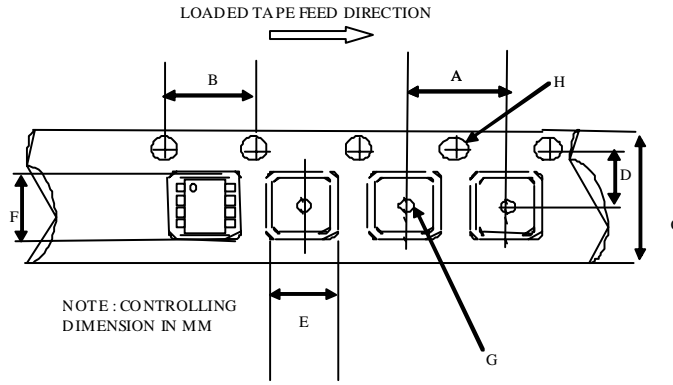


**Figure 32. IRS2308S vs. Frequency (IRFPE50),
 $R_{gate}=10\Omega$, $V_{CC}=15\text{ V}$**

Case outlines

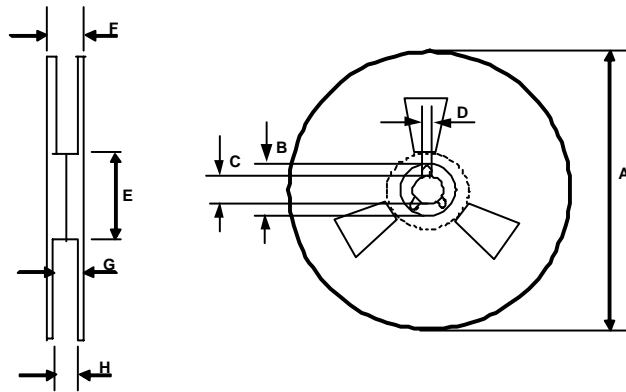


**Tape & Reel
 8-Lead SOIC**



CARRIER TAPE DIMENSION FOR 8SOICN

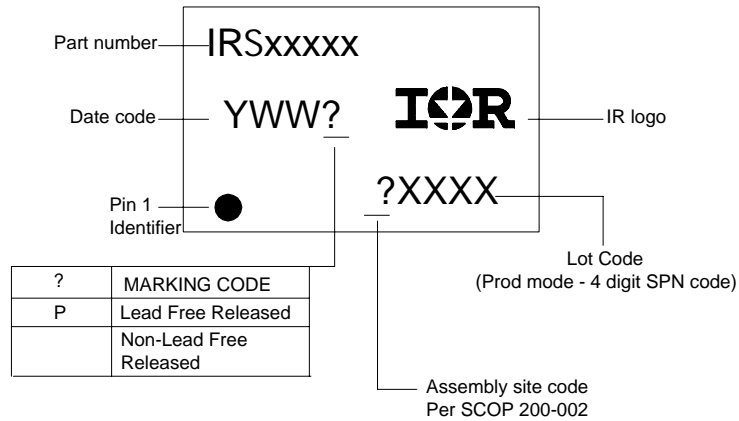
| Code | Metric | | Imperial | |
|------|--------|-------|----------|-------|
| | Min | Max | Min | Max |
| A | 7.90 | 8.10 | 0.311 | 0.318 |
| B | 3.90 | 4.10 | 0.153 | 0.161 |
| C | 11.70 | 12.30 | 0.46 | 0.484 |
| D | 5.45 | 5.55 | 0.214 | 0.218 |
| E | 6.30 | 6.50 | 0.248 | 0.255 |
| F | 5.10 | 5.30 | 0.200 | 0.208 |
| G | 1.50 | n/a | 0.059 | n/a |
| H | 1.50 | 1.60 | 0.059 | 0.062 |



REEL DIMENSIONS FOR 8SOICN

| Code | Metric | | Imperial | |
|------|--------|--------|----------|--------|
| | Min | Max | Min | Max |
| A | 329.60 | 330.25 | 12.976 | 13.001 |
| B | 20.95 | 21.45 | 0.824 | 0.844 |
| C | 12.80 | 13.20 | 0.503 | 0.519 |
| D | 1.95 | 2.45 | 0.767 | 0.096 |
| E | 98.00 | 102.00 | 3.858 | 4.015 |
| F | n/a | 18.40 | n/a | 0.724 |
| G | 14.50 | 17.10 | 0.570 | 0.673 |
| H | 12.40 | 14.40 | 0.488 | 0.566 |

LEADFREE PART MARKING INFORMATION



ORDER INFORMATION

- 8-Lead PDIP IRS2308PbF
- 8-Lead SOIC IRS2308SPbF
- 8-Lead SOIC Tape & Reel IRS2308STRPbF