

0.5mm and 1mm Pitch Connectors For FPC/FFC

FH12 Series

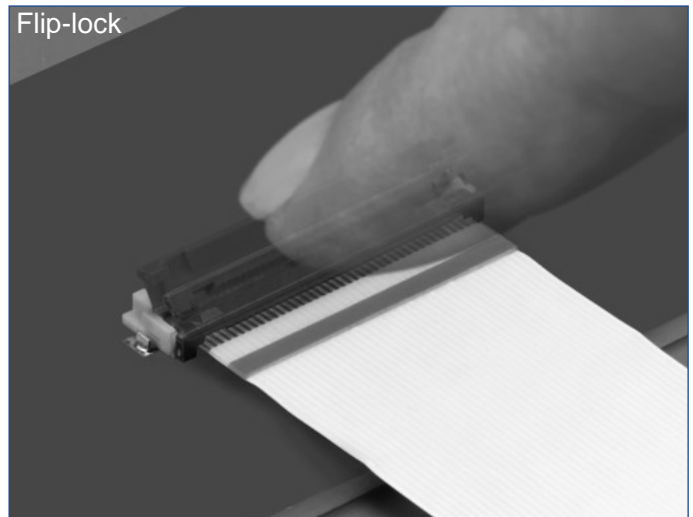
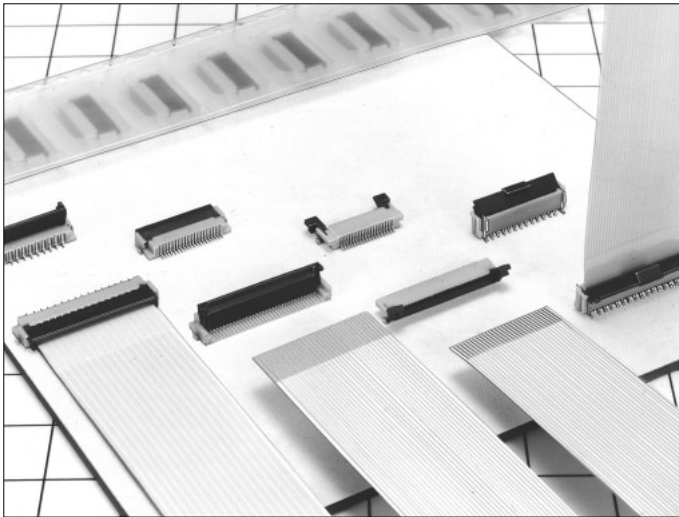

■ Features

1. Ease of Use and Space Savings

Only one finger or 6.9N (Newtons) of force is required to lock Hirose's rotational actuator (flip-lock) as compared to using 2 fingers and 39.2N to close a FFC/FPC connector from our competition.

The Flip-Lock design also allows customers to place 2 or more connectors side by side as there is no need to waste additional board space for a side latch.

2. Strengthened Flip-lock Actuator

The standard Flip-Lock requires only 2.0mm height above the board. A strengthened lock lever is available which only requires an additional 0.4mm.

3. Supports Thin FPC (0.18mm)

Hirose does not require double-sided FPC to have any additional strengthening plate or stiffener and can therefore support a thickness of as little as 0.18mm +/- 0.05.

4. Hirose Ensures Reliability

Hirose's patented half tuning fork contacts maintain the required normal force without relying on the connector housing. With our competitor's conventional products the housing walls support the contact force, which does not provide for long-term reliability.

5. Prevention of Solder Bridge

Excess solder cavity absorbs excessive solder and avoids solder bridging.

6. Three different assembly types

FH12 is offered in Top & Bottom Contact and Vertical Mount and offered in both a 0.5mm contact pitch as well as a 1.0mm contact pitch (bottom contact only).

■ Applications

Notebook computers, printers, PDAs, digital cameras and other compact devices for interconnecting the main circuit board with the LCD, HDD or other device.

Rotating One-touch Mechanism

①

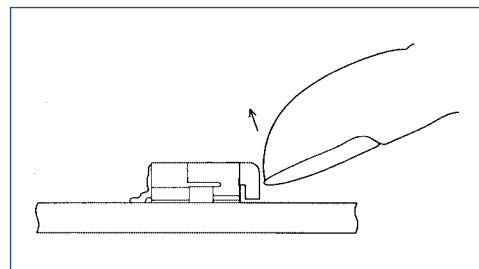

②

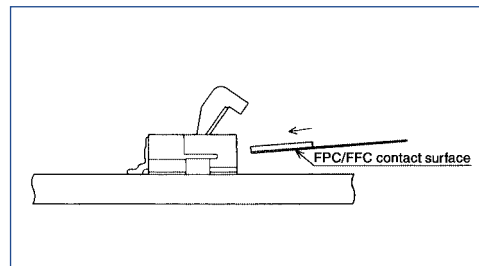

③

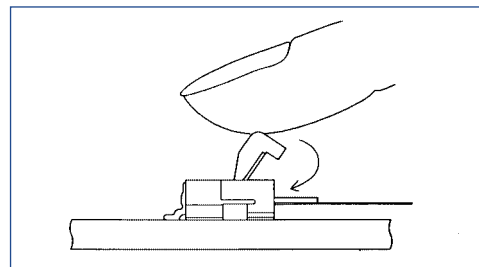

Product Specifications

Rating	Current rating: 0.4A DC	Operating Temperature Range: -40 to +70°C (Note 1)	Storage Temperature Range: -10 to +50°C (Note 2)
	Voltage rating: 50V AC	Operating Humidity Range: Relative humidity, 90% max. (Not dewed)	Storage Humidity Range: Relative humidity, 90% max. (Not dewed)

Applicable FPC	t=0.3±0.05 Tin-lead plated (Note 3)	t=0.18 ± 0.05 for FH12F-*S-0.5SH
----------------	-------------------------------------	----------------------------------

Item	Specification	Conditions
1. Insulation resistance	500M ohms minimum	100V DC
2. Withstanding voltage	No flashover or insulation breakdown.	150V AC/1 minute
3. Contact resistance	50m ohms maximum	1mA
4. Durability (Insertion/withdrawal)	Contact resistance: 50m ohms maximum No damage, cracks, or parts dislocation.	20 cycles
5. Vibration	No electrical discontinuity of 1μs or more Contact resistance: 50m ohms maximum. No damage, cracks, or parts dislocation.	Frequency: 10 to 55 Hz, single amplitude of 0.75 mm, 2 hours in each of the 3 directions.
6. Shock	No electrical discontinuity of 1μs or more Contact resistance: 50m ohms maximum. No damage, cracks, or parts dislocation.	Acceleration of 490 m/s ² , 11 ms duration, sine half-wave waveform, 3 cycles in each of the 3 axis.
7. Humidity (Steady state)	Contact resistance: 50m ohms maximum. Insulation resistance: 50M ohms minimum. No damage, cracks, or parts dislocation.	96 hours at temperature of 40°C and humidity of 90% to 95%
8. Temperature Cycle	Contact resistance: 50m ohms maximum. Insulation resistance: 50M ohms minimum. No damage, cracks, or parts dislocation.	5 cycles under conditions as follows; Temperature: -40°C → 15 to 35°C → 85°C → 15 to 35°C, Time: 30 → 5 max. → 30 → 5 max. (minutes)
9. Resistance to Soldering heat	No deformation of components affecting performance.	Reflow: At the recommended temperature profile Manual soldering: 350±5°C for 3 seconds

Note 1: Includes temperature rise caused by current flow.

Note 2: The term "storage" refers to products stored for long period of time prior to mounting and use. Operating Temperature Range and Humidity range covers nonconducting condition of installed connectors in storage, shipment or during transportation.

Note 3: When FPC is gold plated, the connector contacts should be also gold plated: Select the (55) specification.

Material

Part	Material	Finish	Remarks
Insulator	Polyamide, LCP(60 pos.)	Color : Beige	UL94V-0
	PPS	Color : Dark brown	
Contact	Phosphor bronze	Tin-lead plated	_____
Metal Fittings	Brass	Tin-lead plated	

Ordering Information

FH12 **A** - **10** (**4**) - **S** **A** - **0.5** **SH** (**55**)

①
②
③
④
⑤
⑥
⑦
⑧
⑨

① Series Name : FH12	⑤ Contact alignment: Single
② Blank : standard type A : Top contact type S : Type with strengthened flip-lock actuator F : Type with 0.18mm FPC End Thickness	⑥ Eccentric direction: Blank : standard type A : Eccentric type
③ Standard type : Number of contacts Eccentric type : Number of contacts in 0.5mm housing	⑦ Contacts Pitch : 0.5mm, 1mm
④ Standard type : Blank Eccentric type : Number of contacts	⑧ Contact type SH : SMT horizontal mounting type SV : SMT vertical mounting type
	⑨ Plating specification Blank : Tin-lead plated (55) : Gold plated

◆ Series Configuration

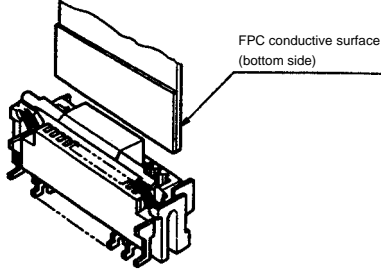
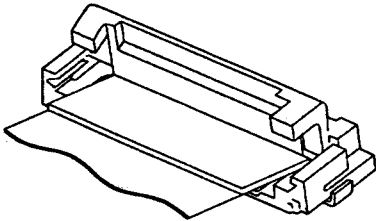
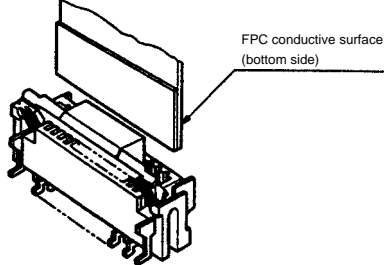
Pitch	Bottom Contact Type	Top Contact Type	Vertical mounting Type
0.5mm	 <p>FH12- ** S-0.5SH P.12</p> <p>Number of contacts 6, 10, 11, 12, 13, 14, 15, 16, 17, 18, 19, 20, 22, 24, 25, 26, 28, 30, 32, 33, 34, 36, 40, 45, 50, 53</p>		
	<p>Type with Strengthened Lock Lever</p>		
	<p>FH12S- ** S-0.5SH P.13</p> <p>Number of contacts 30, 40, 45, 50, 53</p>		
	<p>Type with 0.18mm FPC End Thickness</p> <p>FH12F- ** S-0.5SH P.14</p> <p>Number of contacts 6, 10, 12, 13, 14, 15, 16, 18, 20, 22, 24, 26, 28, 30, 32, (33), 34, 36, 40</p>		
1mm	 <p>Standard FH12- ** S-1SH P.18</p> <p>Eccentric FH12- ** (***) S-1SH Standard</p> <p>Number of contacts 5, 6, 7, 8, 9, 11, 16, 22, 26</p> <p>Eccentric</p> <p>Number of contacts 4, 6, 8, 10, 11, 14, 19, 24</p>		 <p>FH12- ** S-1SV P.19</p> <p>Number of contacts 6, 7, 8, 16, 20, 22, 24</p>

◆ Connector Operating Instructions, precautions and recommendations
 ● Bottom Contact Type (common for 0.5mm/1mm)

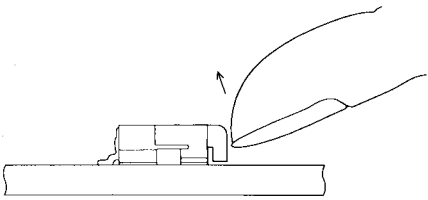
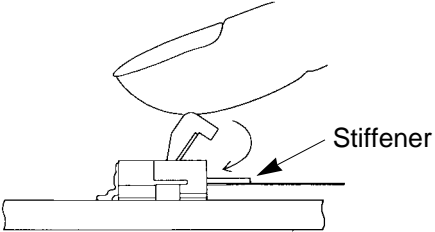
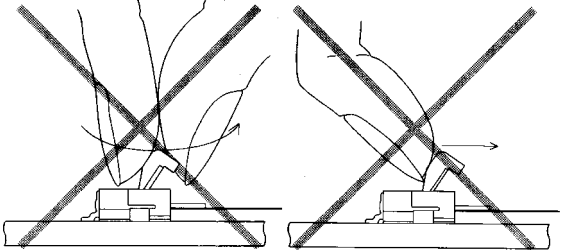
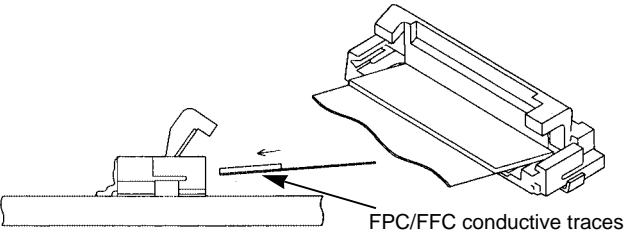
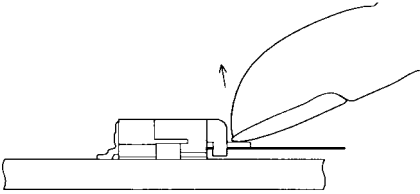
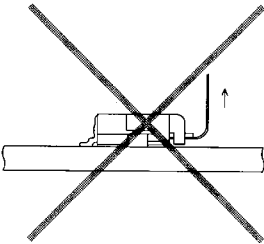
Operation	Precautions
<p>1. FPC/FFC Termination procedure. Connector installed on the board.</p> <p>1) Lift up the actuator. Use thumb or index finger.</p>  <p>2) Rotate down the actuator until firmly closed. It is critical that the inserted FPC/FFC is not moved and remains fully inserted. Should the FPC/FFC be moved, open the actuator and repeat the process, starting with Step 1 above.</p> 	<p>1) Avoid grasping the actuator with two fingers or lifting the actuator with fingernail.</p>  <p>2) Fully insert the FPC/FFC parallel to mounting surface, with the exposed conductive traces facing down.</p> 
<p>2. FPC/FFC Removal</p> <p>1) Lift up the actuator.</p> <p>2) Carefully remove the FPC/FFC.</p> 	<p>3) Due to the structure of the connectors, they do not have strong resistance to upward pulling; therefore, support the FPC/FFC when a pulling force is applied to it.</p> 

■0.5mm Pitch Bottom Contact Type with Strengthened Flip-lock Actuator

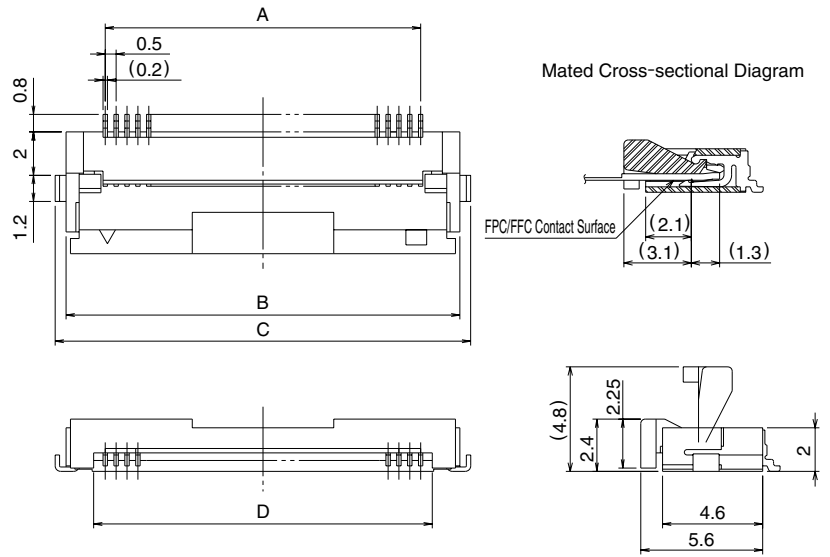

Unit:mm

Part Number	CL No.	Number of Contacts	A	B	C	D
FH12S-30S-0.5SH	586-0667-6	30	14.5	18.1	19.1	15.57
FH12S-40S-0.5SH	586-0640-0	40	19.5	23.1	24.1	20.57
FH12S-45S-0.5SH	586-0665-0	45	22.0	25.6	26.6	23.07
FH12S-50S-0.5SH	586-0642-5	50	24.5	28.1	29.1	25.57
FH12S-53S-0.5SH	586-0691-0	53	26.0	29.6	30.6	27.07

Note: Embossed tape reel packaging (2,000 pieces/reel).
Order by number of reels.

◆ Recommended FPC/FFC dimensions and Land/Metal Mask dimensions

● 0.5mm Pitch Product

	FPC/FFC dimensions	Land / Metal Mask dimensions																																																																																																																																																																																																																								
0.5mm Pitch Bottom Contact Type 0.5mm Pitch Top Contact Type	<table border="1"> <thead> <tr> <th>Product Type</th> <th>C Dimension</th> </tr> </thead> <tbody> <tr> <td>Types other than those below</td> <td>0.3±0.05min Stiffener thickness should be 0.188 mm (7.5 mil) min</td> </tr> <tr> <td>Types with an FPC end thickness of 0.18 mm</td> <td>0.18±0.05</td> </tr> </tbody> </table> <p style="text-align: right;">Unit: mm</p> <table border="1"> <thead> <tr> <th>Dimension</th> <th>A</th> <th>B</th> <th>Dimension</th> <th>A</th> <th>B</th> </tr> </thead> <tbody> <tr><td>6</td><td>2.5</td><td>3.5</td><td>25</td><td>12.0</td><td>13.0</td></tr> <tr><td>10</td><td>4.5</td><td>5.5</td><td>26</td><td>12.5</td><td>13.5</td></tr> <tr><td>11</td><td>5.0</td><td>6.0</td><td>28</td><td>13.5</td><td>14.5</td></tr> <tr><td>12</td><td>5.5</td><td>6.5</td><td>29</td><td>14.0</td><td>15.0</td></tr> <tr><td>13</td><td>6.0</td><td>7.0</td><td>30</td><td>14.5</td><td>15.5</td></tr> <tr><td>14</td><td>6.5</td><td>7.5</td><td>32</td><td>15.5</td><td>16.5</td></tr> <tr><td>15</td><td>7.0</td><td>8.0</td><td>33</td><td>16.0</td><td>17.0</td></tr> <tr><td>16</td><td>7.5</td><td>8.5</td><td>34</td><td>16.5</td><td>17.5</td></tr> <tr><td>17</td><td>8.0</td><td>9.0</td><td>36</td><td>17.5</td><td>18.5</td></tr> <tr><td>18</td><td>8.5</td><td>9.5</td><td>40</td><td>19.5</td><td>20.5</td></tr> <tr><td>19</td><td>9.0</td><td>10.0</td><td>42</td><td>20.5</td><td>21.5</td></tr> <tr><td>20</td><td>9.5</td><td>10.5</td><td>45</td><td>22.0</td><td>23.0</td></tr> <tr><td>22</td><td>10.5</td><td>11.5</td><td>50</td><td>24.5</td><td>25.5</td></tr> <tr><td>24</td><td>11.5</td><td>12.5</td><td>53</td><td>26.0</td><td>27.0</td></tr> </tbody> </table>	Product Type	C Dimension	Types other than those below	0.3±0.05min Stiffener thickness should be 0.188 mm (7.5 mil) min	Types with an FPC end thickness of 0.18 mm	0.18±0.05	Dimension	A	B	Dimension	A	B	6	2.5	3.5	25	12.0	13.0	10	4.5	5.5	26	12.5	13.5	11	5.0	6.0	28	13.5	14.5	12	5.5	6.5	29	14.0	15.0	13	6.0	7.0	30	14.5	15.5	14	6.5	7.5	32	15.5	16.5	15	7.0	8.0	33	16.0	17.0	16	7.5	8.5	34	16.5	17.5	17	8.0	9.0	36	17.5	18.5	18	8.5	9.5	40	19.5	20.5	19	9.0	10.0	42	20.5	21.5	20	9.5	10.5	45	22.0	23.0	22	10.5	11.5	50	24.5	25.5	24	11.5	12.5	53	26.0	27.0	<p style="text-align: center;">Recommended metal mask thickness : 0.15mm</p> <p style="text-align: right;">Unit: mm</p> <table border="1"> <thead> <tr> <th>Dimension</th> <th>A</th> <th>B</th> <th>C</th> <th>Dimension</th> <th>A</th> <th>B</th> <th>C</th> </tr> </thead> <tbody> <tr><td>6</td><td>2.5</td><td>8.1</td><td>4.5</td><td>25</td><td>12.0</td><td>17.6</td><td>14.0</td></tr> <tr><td>10</td><td>4.5</td><td>10.1</td><td>6.5</td><td>26</td><td>12.5</td><td>18.1</td><td>14.5</td></tr> <tr><td>11</td><td>5.0</td><td>10.6</td><td>7.0</td><td>28</td><td>13.5</td><td>19.1</td><td>15.5</td></tr> <tr><td>12</td><td>5.5</td><td>11.1</td><td>7.5</td><td>29</td><td>14.0</td><td>19.6</td><td>16.0</td></tr> <tr><td>13</td><td>6.0</td><td>11.6</td><td>8.0</td><td>30</td><td>14.5</td><td>20.1</td><td>16.5</td></tr> <tr><td>14</td><td>6.5</td><td>12.1</td><td>8.5</td><td>32</td><td>15.5</td><td>21.1</td><td>17.5</td></tr> <tr><td>15</td><td>7.0</td><td>12.6</td><td>9.0</td><td>33</td><td>16.0</td><td>21.6</td><td>18.0</td></tr> <tr><td>16</td><td>7.5</td><td>13.1</td><td>9.5</td><td>34</td><td>16.5</td><td>22.1</td><td>18.5</td></tr> <tr><td>17</td><td>8.0</td><td>13.6</td><td>10.0</td><td>36</td><td>17.5</td><td>23.1</td><td>19.5</td></tr> <tr><td>18</td><td>8.5</td><td>14.1</td><td>10.5</td><td>40</td><td>19.5</td><td>25.1</td><td>21.5</td></tr> <tr><td>19</td><td>9.0</td><td>14.6</td><td>11.0</td><td>42</td><td>20.5</td><td>26.1</td><td>22.5</td></tr> <tr><td>20</td><td>9.5</td><td>15.1</td><td>11.5</td><td>45</td><td>22.0</td><td>27.6</td><td>24.0</td></tr> <tr><td>22</td><td>10.5</td><td>16.1</td><td>12.5</td><td>50</td><td>24.5</td><td>30.1</td><td>26.5</td></tr> <tr><td>24</td><td>11.5</td><td>17.1</td><td>13.5</td><td>53</td><td>26.0</td><td>31.6</td><td>28.0</td></tr> </tbody> </table>	Dimension	A	B	C	Dimension	A	B	C	6	2.5	8.1	4.5	25	12.0	17.6	14.0	10	4.5	10.1	6.5	26	12.5	18.1	14.5	11	5.0	10.6	7.0	28	13.5	19.1	15.5	12	5.5	11.1	7.5	29	14.0	19.6	16.0	13	6.0	11.6	8.0	30	14.5	20.1	16.5	14	6.5	12.1	8.5	32	15.5	21.1	17.5	15	7.0	12.6	9.0	33	16.0	21.6	18.0	16	7.5	13.1	9.5	34	16.5	22.1	18.5	17	8.0	13.6	10.0	36	17.5	23.1	19.5	18	8.5	14.1	10.5	40	19.5	25.1	21.5	19	9.0	14.6	11.0	42	20.5	26.1	22.5	20	9.5	15.1	11.5	45	22.0	27.6	24.0	22	10.5	16.1	12.5	50	24.5	30.1	26.5	24	11.5	17.1	13.5	53	26.0	31.6	28.0
	Product Type	C Dimension																																																																																																																																																																																																																								
Types other than those below	0.3±0.05min Stiffener thickness should be 0.188 mm (7.5 mil) min																																																																																																																																																																																																																									
Types with an FPC end thickness of 0.18 mm	0.18±0.05																																																																																																																																																																																																																									
Dimension	A	B	Dimension	A	B																																																																																																																																																																																																																					
6	2.5	3.5	25	12.0	13.0																																																																																																																																																																																																																					
10	4.5	5.5	26	12.5	13.5																																																																																																																																																																																																																					
11	5.0	6.0	28	13.5	14.5																																																																																																																																																																																																																					
12	5.5	6.5	29	14.0	15.0																																																																																																																																																																																																																					
13	6.0	7.0	30	14.5	15.5																																																																																																																																																																																																																					
14	6.5	7.5	32	15.5	16.5																																																																																																																																																																																																																					
15	7.0	8.0	33	16.0	17.0																																																																																																																																																																																																																					
16	7.5	8.5	34	16.5	17.5																																																																																																																																																																																																																					
17	8.0	9.0	36	17.5	18.5																																																																																																																																																																																																																					
18	8.5	9.5	40	19.5	20.5																																																																																																																																																																																																																					
19	9.0	10.0	42	20.5	21.5																																																																																																																																																																																																																					
20	9.5	10.5	45	22.0	23.0																																																																																																																																																																																																																					
22	10.5	11.5	50	24.5	25.5																																																																																																																																																																																																																					
24	11.5	12.5	53	26.0	27.0																																																																																																																																																																																																																					
Dimension	A	B	C	Dimension	A	B	C																																																																																																																																																																																																																			
6	2.5	8.1	4.5	25	12.0	17.6	14.0																																																																																																																																																																																																																			
10	4.5	10.1	6.5	26	12.5	18.1	14.5																																																																																																																																																																																																																			
11	5.0	10.6	7.0	28	13.5	19.1	15.5																																																																																																																																																																																																																			
12	5.5	11.1	7.5	29	14.0	19.6	16.0																																																																																																																																																																																																																			
13	6.0	11.6	8.0	30	14.5	20.1	16.5																																																																																																																																																																																																																			
14	6.5	12.1	8.5	32	15.5	21.1	17.5																																																																																																																																																																																																																			
15	7.0	12.6	9.0	33	16.0	21.6	18.0																																																																																																																																																																																																																			
16	7.5	13.1	9.5	34	16.5	22.1	18.5																																																																																																																																																																																																																			
17	8.0	13.6	10.0	36	17.5	23.1	19.5																																																																																																																																																																																																																			
18	8.5	14.1	10.5	40	19.5	25.1	21.5																																																																																																																																																																																																																			
19	9.0	14.6	11.0	42	20.5	26.1	22.5																																																																																																																																																																																																																			
20	9.5	15.1	11.5	45	22.0	27.6	24.0																																																																																																																																																																																																																			
22	10.5	16.1	12.5	50	24.5	30.1	26.5																																																																																																																																																																																																																			
24	11.5	17.1	13.5	53	26.0	31.6	28.0																																																																																																																																																																																																																			
0.5mm Pitch Vertical Mounting Type	<p style="text-align: center;">*Set the stiffener thickness to 0.188 (7.5mil) min.</p> <p style="text-align: right;">Unit: mm</p> <table border="1"> <thead> <tr> <th>Dimension</th> <th>A</th> <th>B</th> <th>Dimension</th> <th>A</th> <th>B</th> </tr> </thead> <tbody> <tr><td>10</td><td>4.5</td><td>5.5</td><td>26</td><td>12.5</td><td>13.5</td></tr> <tr><td>12</td><td>5.5</td><td>6.5</td><td>30</td><td>14.5</td><td>15.5</td></tr> <tr><td>13</td><td>6.0</td><td>7.0</td><td>32</td><td>15.5</td><td>16.5</td></tr> <tr><td>15</td><td>7.0</td><td>8.0</td><td>33</td><td>16.0</td><td>17.0</td></tr> <tr><td>16</td><td>7.5</td><td>8.5</td><td>34</td><td>16.5</td><td>17.5</td></tr> <tr><td>17</td><td>8.0</td><td>9.0</td><td>36</td><td>17.5</td><td>18.5</td></tr> <tr><td>18</td><td>8.5</td><td>9.5</td><td>40</td><td>19.5</td><td>20.5</td></tr> <tr><td>20</td><td>9.5</td><td>10.5</td><td>45</td><td>22.0</td><td>23.0</td></tr> <tr><td>22</td><td>10.5</td><td>11.5</td><td>49</td><td>24.0</td><td>25.0</td></tr> <tr><td>24</td><td>11.5</td><td>12.5</td><td>50</td><td>24.5</td><td>25.5</td></tr> <tr><td></td><td></td><td></td><td>60</td><td>29.5</td><td>30.5</td></tr> </tbody> </table>	Dimension	A	B	Dimension	A	B	10	4.5	5.5	26	12.5	13.5	12	5.5	6.5	30	14.5	15.5	13	6.0	7.0	32	15.5	16.5	15	7.0	8.0	33	16.0	17.0	16	7.5	8.5	34	16.5	17.5	17	8.0	9.0	36	17.5	18.5	18	8.5	9.5	40	19.5	20.5	20	9.5	10.5	45	22.0	23.0	22	10.5	11.5	49	24.0	25.0	24	11.5	12.5	50	24.5	25.5				60	29.5	30.5	<p style="text-align: center;">Recommended metal mask thickness : 0.15mm</p> <p style="text-align: right;">Unit: mm</p> <table border="1"> <thead> <tr> <th>Dimension</th> <th>A</th> <th>B</th> <th>Dimension</th> <th>A</th> <th>B</th> </tr> </thead> <tbody> <tr><td>10</td><td>6.5</td><td>4.5</td><td>26</td><td>14.5</td><td>12.5</td></tr> <tr><td>12</td><td>7.5</td><td>5.5</td><td>30</td><td>16.5</td><td>14.5</td></tr> <tr><td>13</td><td>8.0</td><td>6.0</td><td>32</td><td>17.5</td><td>15.5</td></tr> <tr><td>15</td><td>9.0</td><td>7.0</td><td>33</td><td>18.0</td><td>16.0</td></tr> <tr><td>16</td><td>9.5</td><td>7.5</td><td>34</td><td>18.5</td><td>16.5</td></tr> <tr><td>17</td><td>10.0</td><td>8.0</td><td>36</td><td>19.5</td><td>17.5</td></tr> <tr><td>18</td><td>10.5</td><td>8.5</td><td>40</td><td>21.5</td><td>19.5</td></tr> <tr><td>20</td><td>11.5</td><td>9.5</td><td>45</td><td>24.0</td><td>22.0</td></tr> <tr><td>22</td><td>12.5</td><td>10.5</td><td>49</td><td>26.0</td><td>24.0</td></tr> <tr><td>24</td><td>13.5</td><td>11.5</td><td>50</td><td>26.5</td><td>24.5</td></tr> <tr><td></td><td></td><td></td><td>60</td><td>31.5</td><td>29.5</td></tr> </tbody> </table>	Dimension	A	B	Dimension	A	B	10	6.5	4.5	26	14.5	12.5	12	7.5	5.5	30	16.5	14.5	13	8.0	6.0	32	17.5	15.5	15	9.0	7.0	33	18.0	16.0	16	9.5	7.5	34	18.5	16.5	17	10.0	8.0	36	19.5	17.5	18	10.5	8.5	40	21.5	19.5	20	11.5	9.5	45	24.0	22.0	22	12.5	10.5	49	26.0	24.0	24	13.5	11.5	50	26.5	24.5				60	31.5	29.5																																																																								
Dimension	A	B	Dimension	A	B																																																																																																																																																																																																																					
10	4.5	5.5	26	12.5	13.5																																																																																																																																																																																																																					
12	5.5	6.5	30	14.5	15.5																																																																																																																																																																																																																					
13	6.0	7.0	32	15.5	16.5																																																																																																																																																																																																																					
15	7.0	8.0	33	16.0	17.0																																																																																																																																																																																																																					
16	7.5	8.5	34	16.5	17.5																																																																																																																																																																																																																					
17	8.0	9.0	36	17.5	18.5																																																																																																																																																																																																																					
18	8.5	9.5	40	19.5	20.5																																																																																																																																																																																																																					
20	9.5	10.5	45	22.0	23.0																																																																																																																																																																																																																					
22	10.5	11.5	49	24.0	25.0																																																																																																																																																																																																																					
24	11.5	12.5	50	24.5	25.5																																																																																																																																																																																																																					
			60	29.5	30.5																																																																																																																																																																																																																					
Dimension	A	B	Dimension	A	B																																																																																																																																																																																																																					
10	6.5	4.5	26	14.5	12.5																																																																																																																																																																																																																					
12	7.5	5.5	30	16.5	14.5																																																																																																																																																																																																																					
13	8.0	6.0	32	17.5	15.5																																																																																																																																																																																																																					
15	9.0	7.0	33	18.0	16.0																																																																																																																																																																																																																					
16	9.5	7.5	34	18.5	16.5																																																																																																																																																																																																																					
17	10.0	8.0	36	19.5	17.5																																																																																																																																																																																																																					
18	10.5	8.5	40	21.5	19.5																																																																																																																																																																																																																					
20	11.5	9.5	45	24.0	22.0																																																																																																																																																																																																																					
22	12.5	10.5	49	26.0	24.0																																																																																																																																																																																																																					
24	13.5	11.5	50	26.5	24.5																																																																																																																																																																																																																					
			60	31.5	29.5																																																																																																																																																																																																																					

◆ Packaging Specification

Embossed Carrier Tape Dimensions

Horizontal Type (Common to Bottom/Top Contact, 0.5mm/1mm Pitch)

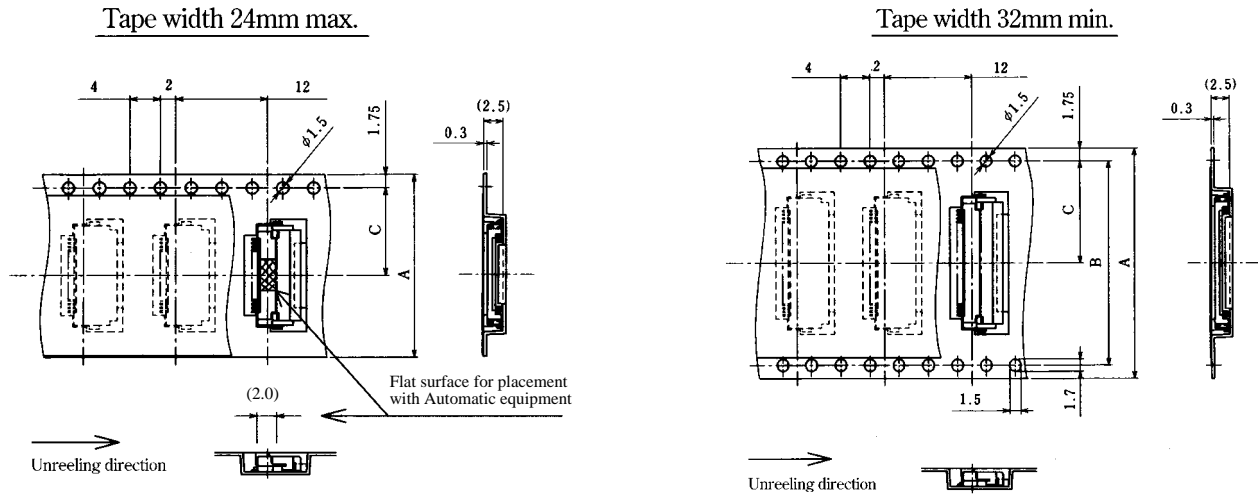

● 0.5mm Pitch Bottom/Top Contact Type

Unit:mm

Dimension Number of Contacts	A	B	C	D	Dimension Number of Contacts	A	B	C	D
6	16	—	7.5	16.5	25	24	—	11.5	24.5
10	16	—	7.5	16.5	26	24	—	11.5	24.5
11	16	—	7.5	16.5	28	32	28.4	14.2	32.5
12	24	—	11.5	24.5	29	32	28.4	14.2	32.5
13	24	—	11.5	24.5	30	32	28.4	14.2	32.5
14	24	—	11.5	24.5	32	32	28.4	14.2	32.5
15	24	—	11.5	24.5	33	32	28.4	14.2	32.5
16	24	—	11.5	24.5	34	32	28.4	14.2	32.5
17	24	—	11.5	24.5	36	44	40.4	20.2	44.5
18	24	—	11.5	24.5	40	44	40.4	20.2	44.5
19	24	—	11.5	24.5	42	44	40.4	20.2	44.5
20	24	—	11.5	24.5	45	44	40.4	20.2	44.5
22	24	—	11.5	24.5	50	44	40.4	20.2	44.5
24	24	—	11.5	24.5	53	44	40.4	20.2	44.5

Note: 2,000 pieces per reel.

● 1mm Pitch Bottom Contact Type

Unit:mm

Dimension Number of Contacts	A	B	C	D	Dimension Number of Contacts	A	B	C	D		
Standard Type	5	16	—	7.5	16.5	Eccentric Type	4	16	—	7.5	16.5
	6	24	—	11.5	24.5		6	24	—	11.5	24.5
	7	24	—	11.5	24.5		8	24	—	11.5	24.5
	8	24	—	11.5	24.5		10	24	—	11.5	24.5
	9	24	—	11.5	24.5		11	24	—	11.5	24.5
	11	24	—	11.5	24.5		14	32	28.4	14.2	32.5
	16	32	28.4	14.2	32.5		19	44	40.4	20.2	44.5
	22	44	40.4	20.2	44.5		24	44	40.4	20.2	44.5
26	44	40.4	20.2	44.5							

Note: 2,000 pieces per reel.

Reel Dimensions (Common to All Types)

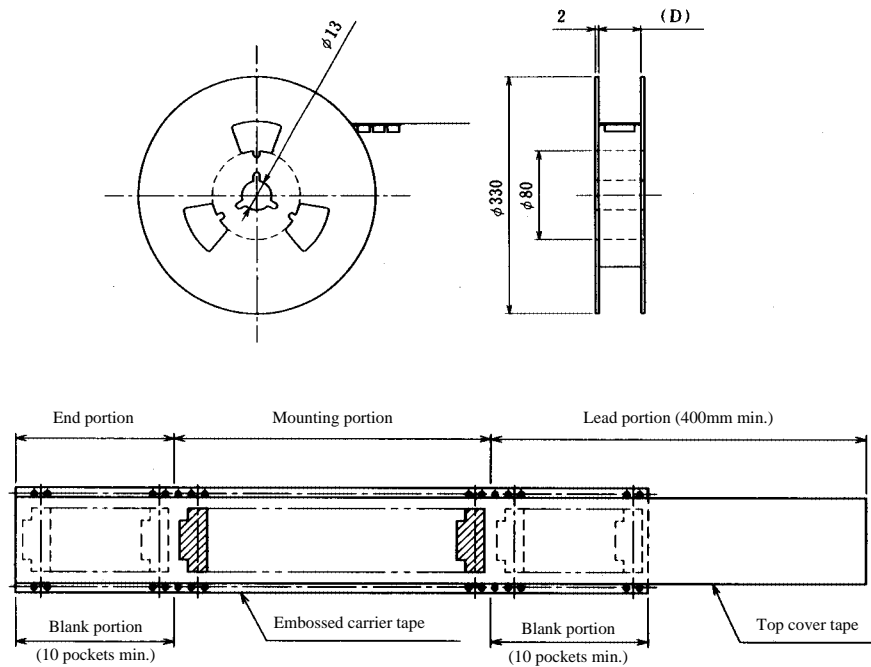

Recommended Temperature Profile

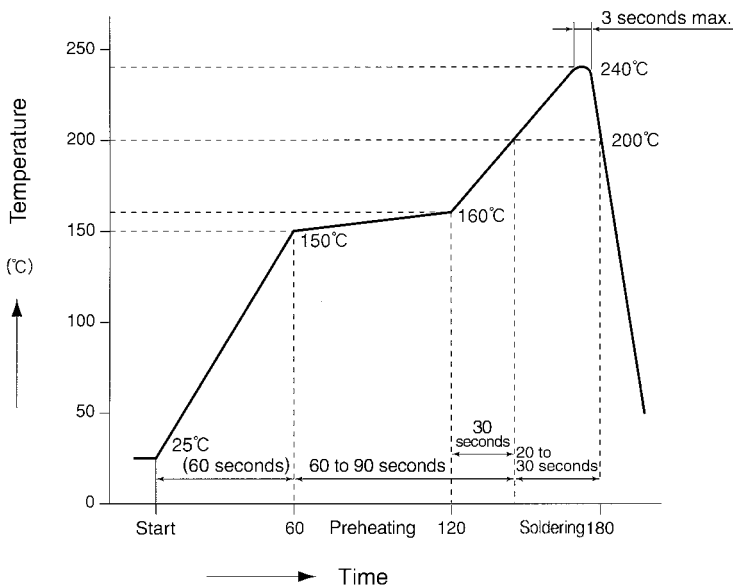

HRS test conditions

Solder method	:Reflow, IR/hot air (Nihon Den-netsu Co., Ltd.'s Part Number: SENSBY NR- II)
Environment:	:Room air
Solder composition	:Paste, 63%Sn/37%Pb (Senju Metal Industry, Co., Ltd.'s Part Number: OZ63-201C-50-9)
Test board	:Glass epoxy 40mm×80mm×1.6mm thick
Land dimensions	:Top and bottom contact type 0.3mm×1.3mm Vertical mounting type 0.6mm×1.5mm
Metal mask	:Top and bottom contact type 0.25mm×1.3mm×0.15mm thick Vertical mounting type 0.5mm×1.5mm×0.15mm thick

This temperature profile is based on the above conditions. In individual applications the actual temperature may vary, depending on solder paste type, volume/thickness and board size/thickness. Consult your solder paste and equipment manufacturer for specific recommendations.

◆FH12 Series FPC/FFC Construction (Recommended Specifications)

1. FFC

FFC : Flexible Flat Cable

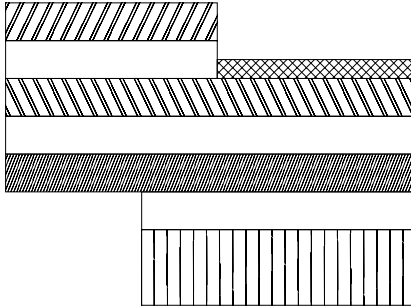

Material Name	Material	Thickness (μm)
---------------	----------	----------------

Hard copper foil with tin plating		35
Adhesive	Polyester type	30
Polyester		12
Adhesive	Polyester type	30
Stiffener	Polyester type	188 (Note)
Total		295

*Real tolerance of thickness dimension is on the order of $\pm 20 \mu\text{m}$ (275 to 315 μm)

Note: Use of a thicker FFC results in a stiffer lock action and the lock is more easily released.

A factor that contributes to thicker FFC is the use of 250 μm stiffener which is thicker than the standard (188 μm) product. This results in a total thickness of 357 μm .

When using FFC, control of FFC thickness becomes easy if you indicate to us the thickness of the stiffener.

2. FPC

FPC : Flexible Printed Circuit

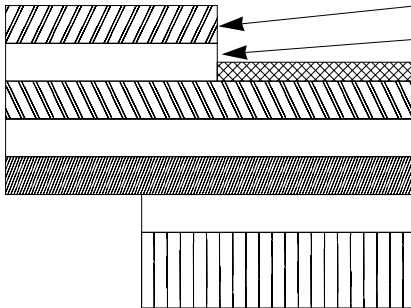

Material Name	Material	Thickness (μm)
---------------	----------	----------------

Covering layer film	Polyamide 1 mil	25
Cover adhesive		25
Surface treatment	Tin-lead	5
Copper foil	Cu 1oz	35
Base adhesive		25
Base film	Polyamide 1 mil	25
Reinforcement material adhesive	Heat-hardened adhesive	30
Stiffener	Polyamide 7 mil	175
Total		295

3. Precautions

1. This specification is a recommendation for the construction of the FH12 Series FPC and FFC ($t=0.3 \pm 0.05$).
2. For details about the construction, please contact the FPC/FFC manufacturers.