

# 1.25mm Pitch Miniature Crimping Connector

## DF13 Series

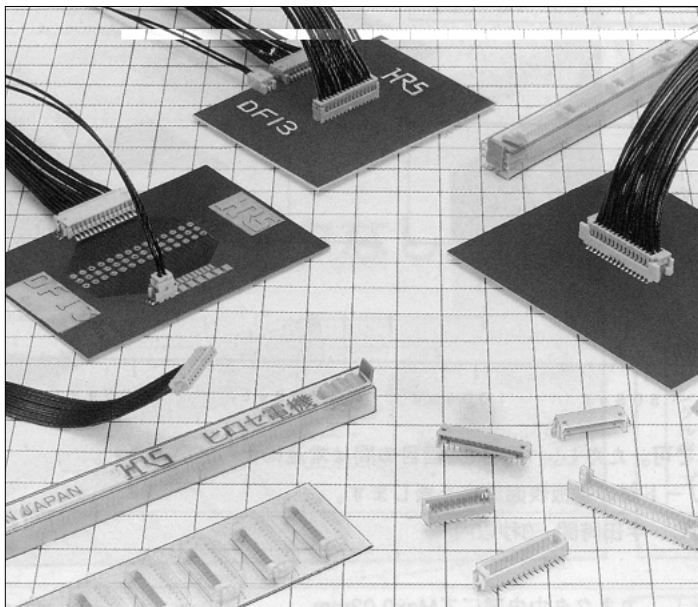

	Type	Mounting Type	Mounting Height
Straight Type	DIP		5.3mm
	SMT		5.8mm
Right Angle Type	DIP		3.6mm
	SMT		

### ■ Features

#### 1. Miniature Size

Designed in the low profile at mounting height 5.8mm.  
 (SMT mounting straight type)  
 (For DIP type, the mounting height is to 5.3mm to the straight and 3.6mm at the right angle)

#### 2. Multi-contact

The double row type achieves the multi-contact up to 40 contacts, and secures 30% higher density in the mounting area, compared with the single row type.

#### 3. Correspond to Automatic Mounting

The header provides the grade with the vacuum absorption area, and secures automatic mounting by the embossed tape packaging.  
 In addition, the tube packaging can be selected.

#### 4. Integral Basic Function Despite Miniature Size

The header is designed in a scoop-proof box structure, and completely prevents mis-insertion.  
 In addition, the surface mounting (SMT) header is equipped with the metal fitting to prevent solder peeling.

### ■ Applications

Note PC, mobile terminal, miniature type business equipment, and other various consumer equipment, including video camera

Correspond to Automatic Mounting  
 Secure the automatic plain area for the absorption type automatic mounting machine.

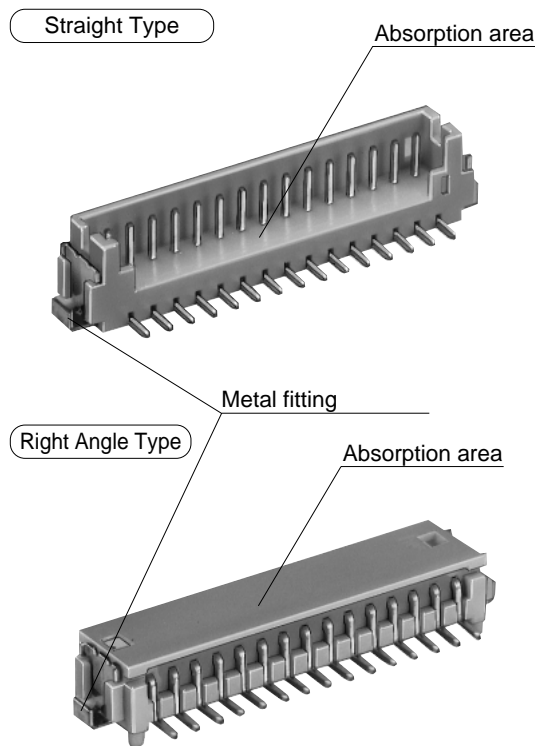

Figure 1

## Product Specifications

Rating	Current rating 1A	Operating Temperature Range: -35 to +85°C (Note 1)	Storage Temperature Range: -10 to +60°C (Note 2)
	Voltage rating 150V AC	Operating Moisture Range: 40 to 80%	Storage Moisture Range: 40 to 70% (Note 2)

Item	Specification	Condition
1. Insulation Resistance	500M ohms min.	100V DC
2. Withstanding voltage	No flashover or insulation breakdown.	500V AC/1 minute
3. Contact Resistance	30m ohms max.	100mA
4. Single Insertion/Extraction Force	0.3N (30gf) min., 3N (300gf) max.	Measured at the square steel pin of 0.35±0.002mm
5. Vibration	No electrical discontinuity of 1μs or more	Frequency: 10 to 55 Hz, single amplitude of 0.75 mm, 2 hours in each of the 3 directions.
6. Humidity (Steady state)	Contact resistance: 30m ohms max. Insulation resistance: 500M ohms min.	96 hours at temperature of 40°C and humidity of 90% to 95%
7. Temperature Cycle	Contact resistance: 30m ohms max. Insulation resistance: 500M ohms min.	(-55°C: 30 minutes → 5 to 35°C: 10 minutes → 85°C: 30 minutes → 5 to 35°C: 10 minutes) 5 cycles
8. Durability (Mating/un-mating)	Contact resistance: 30m ohms max.	Tin plating: 30 cycles Gold plating: 50 cycles
9. Resistance to Soldering heat	No deformation of components affecting performance.	Flow: 250°C for 10 seconds
		Manual soldering: 300°C for 3 seconds
		Reflow: At the recommended temperature profile
		Manual soldering: 300°C for 3 seconds

Note 1: Includes temperature rise caused by current flow.

Note 2: The term "storage" refers to products stored for long period of time prior to mounting and use. Operating Temperature Range and Humidity range covers non conducting condition of installed connectors in storage, shipment or during transportation.

## Material

Product	Part	Material	Finish	Remarks
Crimping Socket	Insulator	Polyamide	Beige	UL94V-0
Crimping Contact for Socket	Contact	Phosphor copper	Tin plated or gold plated	———
Pin Header (Through hole)	Insulator	Polyamide	Beige	UL94V-0
	Contact	Brass	Tin plated	———
Pin Header (SMT)	Insulator	Polyamide	Beige	UL94V-0
	Contact	Brass	Tin plated or gold plated	———
	Metal Fitting	Phosphor copper	Tin plated	———

## Ordering Information

### Connector

DF13
#
-
\*
S
-
1.25
C

①
②
③
④
⑤
⑥

① Series Name : DF13	③ Number of Contacts Single row: 2 to 12, 14, 15 Double row: 10, 20, 30, 40	⑤ Contact Pitch: 1.25mm
② Style Symbol : Blank: With boss A: Without boss V Type — B: With boss, embossed tape type — C: Without boss, embossed tape type	④ Connector Type S: Single row socket / P: Single row pin header DS: Double row socket / DP: Double row pin header	⑥ Contact Type C : Crimping socket / DSA : Straight through hole DS : Right angle through hole / V : Straight SMT H : Right angle SMT

### Contact

DF 13
-
2630
SCF
A

①
②
③

① Applicable Cable Size 2630: AWG26 to 30	③ Plating Type Blank: Tin plated A : Gold plated
② Packaging Type SCF: Socket Contact/Reel	

## Single Row Socket

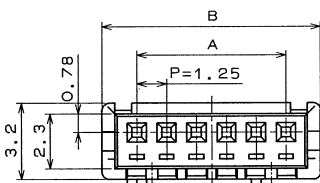
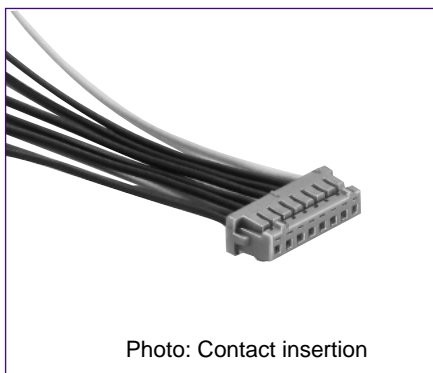

[Specific No.] - \*\*, (\*\*)  
 Blank: 1 bag: 100 pcs.

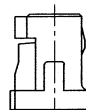
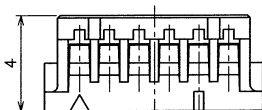

Contact No.1 mark

Marking per 5 contacts

Unit: mm

Part Number	CL No.	Number of Contacts	A	B	Part Number	CL No.	Number of Contacts	A	B
DF13-2S-1.25C(**)	536-0001-4-**	2	1.25	4.15	DF13- 9S-1.25C(**)	536-0008-3-**	9	10.00	12.90
DF13-3S-1.25C(**)	536-0002-7-**	3	2.50	5.40	DF13-10S-1.25C(**)	536-0009-6-**	10	11.25	14.15
DF13-4S-1.25C(**)	536-0003-0-**	4	3.75	6.65	DF13-11S-1.25C(**)	536-0010-5-**	11	12.50	15.40
DF13-5S-1.25C(**)	536-0004-2-**	5	5.00	7.90	DF13-12S-1.25C(**)	536-0011-8-**	12	13.75	16.65
DF13-6S-1.25C(**)	536-0005-5-**	6	6.25	9.15	DF13-14S-1.25C(**)	536-0013-3-**	14	16.25	19.15
DF13-7S-1.25C(**)	536-0006-8-**	7	7.50	10.40	DF13-15S-1.25C(**)	536-0014-6-**	15	17.50	20.40
DF13-8S-1.25C(**)	536-0007-0-**	8	8.75	11.65					

Note 1. The quantity at the specific No. "None" is delivered per bag (100 pcs.). If needed, please select and order the products per bag.

## Double Row Socket

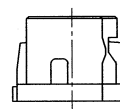
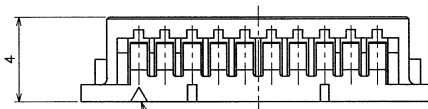
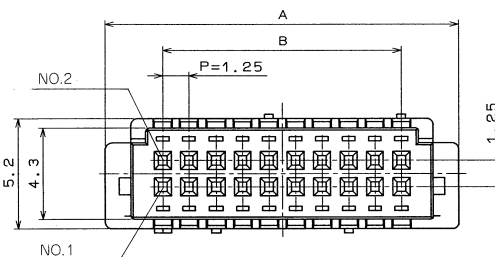
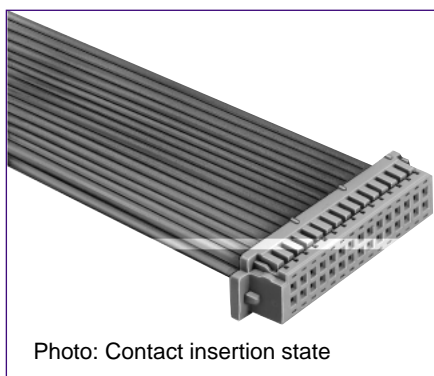

Contact No.1 mark

Unit: mm

[Specific No.] - \*\*, (\*\*)  
 Blank: 1 bag: 100 pcs.

Part Number	CL No.	Number of Contacts	A	B
DF13-10DS-1.25C(**)	536-0550-2-**	10	10.40	5.00
DF13-20DS-1.25C(**)	536-0555-6-**	20	16.65	11.25
DF13-30DS-1.25C(**)	536-0560-6-**	30	22.90	17.50
DF13-40DS-1.25C(**)	536-0565-0-**	40	29.15	23.75

Note: The quantity at the specific No. "Blank" is delivered per bag (100 pcs.). If needed, please select and order the products per bag.