















Multi Purpose Die Cast

Features:

- Rugged Aluminium.
- 4 sides PCB guides.
- Stand offs.
- Zink plated screws for tapped holes.
- Neoprene rubber gasket.
- Easy to machine.
- BS colour choice.

5000 Series

Version Code				Dimensions (mm)			PDF	DWG
Nylon Coated	Hammer Tone	Black	White	D/L	W	H		
5001/11-NC	5001/11-PAT	5001/11-BK	5001/11-WH	50	50	31		
5002/12-NC	5002/12-PAT	5002/12-BK	5002/12-WH	101	50	24.5		
5003/13-NC	5003/13-PAT	5003/13-BK	5003/13-WH	112	62	30.5		
5004/14-NC	5004/14-PAT	5004/14-BK	5004/14-WH	120	65.5	39.5		
5007/17-NC	5007/17-PAT	5007/17-BK	5007/17-WH	121	95	61		
5005/15-NC	5005/15-PAT	5005/15-BK	5005/15-WH	152	82	50		
5006/16-NAT	5006/16-PAT	5006/16-BK	5006/16-WH	191.5	111.5	60.5		

OVERALL ASSEMBLY DIMENSIONS:

EXTERNAL - 120 x 65.5 x 39.5

INTERNAL - 116.4 x 61.9 x 35.3

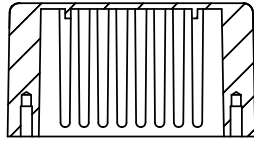

SECTION B-B

M3 CSK SCREW

LID

BASE

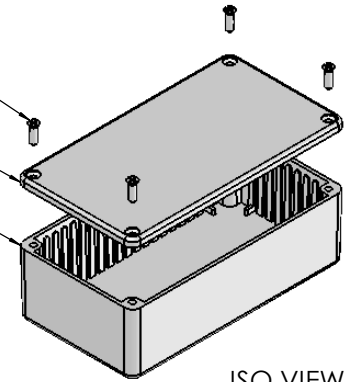

ISO VIEW
1:3

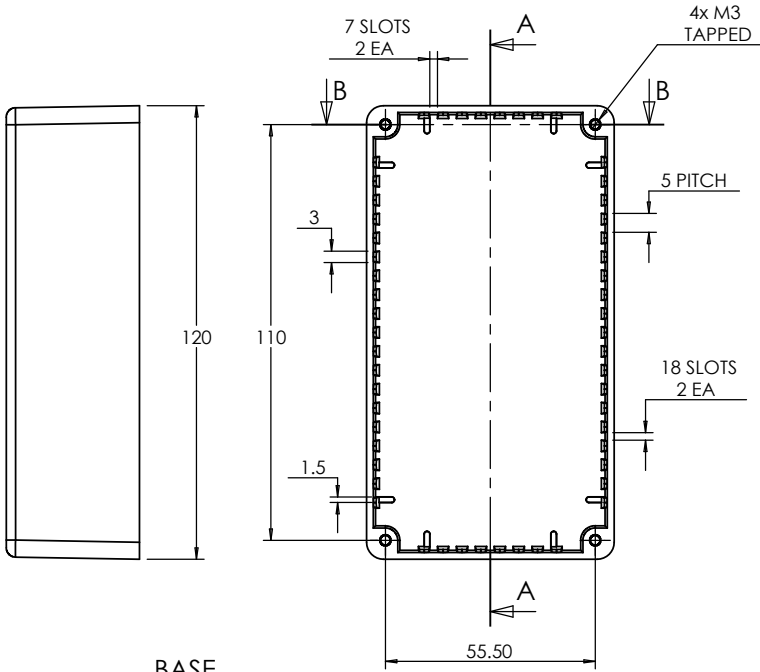

BASE

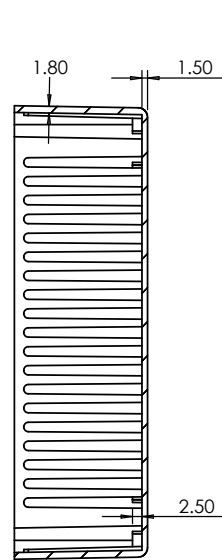

SECTION A-A

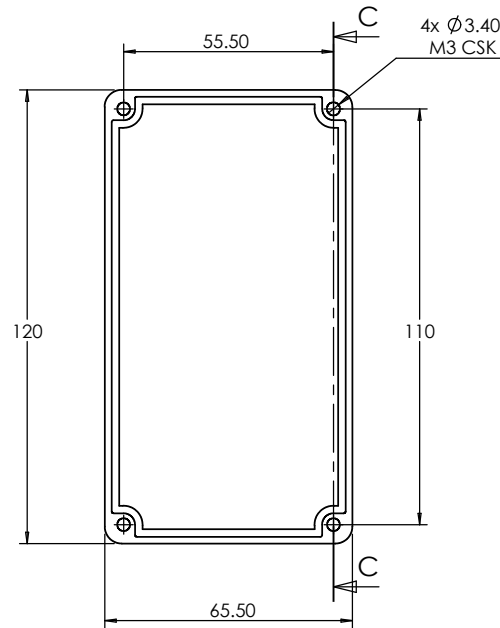

SECTION C-C

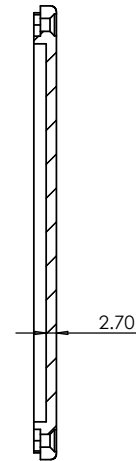

LID

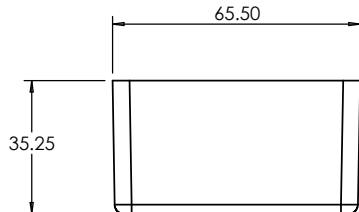

<p>JAMES CARTER RD, MILDENHALL, SUFFOLK. IP28 7DE TEL: 01638 716101 FAX: 01638 716554 EMAIL: SALES@BOSS-ENCLOSURES.CO.UK WEB: www.BOSS-ENCLOSURES.CO.UK</p>				UNLESS OTHERWISE SPECIFIED: DIMENSIONS ARE IN MILLIMETERS		DO NOT SCALE DRAWING		REVISION. 0	
				FINISH: SMOOTH		TITLE: ASSEMBLY DRG FOR 5004/14			
DRAWN S.HARDINGE		SIGNED SJH		DATE 06/12/05		MATERIAL: DIE-CAST ALUMINIUM		DWG NO. 5004,14	
CHK'D -		-		-		PROJECTION. 		SCALE: 1:2	
								SHEET 1 OF 1	

A4