

## CIRCUITS & DESIGN

## MEASUREMENT REPORT

Measured product:

**Board-to-Board Coaxial Connector  
619134-1 : 10mm**

Description: This report describes the RF performance of the 10mm BtB coaxial connector

Date: 08-08-2005  
Issued: 07-09-2005  
REF: 501-90024 rev. O51

Issued by:

Mr. Lieven Decrock  
Signal Integrity Engineer  
C&D EMEA

## Contents

<b>1</b>	<b>SAMPLE DESCRIPTION.....</b>	<b>3</b>
<b>2</b>	<b>PERFORMANCE REQUIREMENTS.....</b>	<b>3</b>
<b>3</b>	<b>MEASUREMENT SETUP .....</b>	<b>4</b>
3.1	MEASURING CONNECTORS WITH NETWORK ANALYZER.....	4
3.2	MOUNTING CONDITIONS.....	4
<b>4</b>	<b>MEASUREMENT RESULTS .....</b>	<b>5</b>
4.1	GATING PROCEDURE.....	5
4.2	RETURN LOSS.....	6
4.2.1	At minimal misalignment.....	6
4.2.2	At maximal misalignment.....	6
4.2.3	Influence of inclination.....	7
4.2.3.1	At minimal misalignment.....	7
4.2.3.2	At maximal misalignment.....	7
4.3	INSERTION LOSS.....	8
4.3.1	At minimal misalignment.....	8
4.3.2	At maximal misalignment.....	8
4.3.3	Influence of inclination.....	9
4.3.3.1	At minimal misalignment.....	9
4.3.3.2	At maximal misalignment.....	9
<b>5</b>	<b>CONCLUSIONS.....</b>	<b>10</b>

## 1 Sample Description

3 samples have been measured (Table 1).

Connector P/N	Height of connector	Number of measured samples
619134-1	10 mm	3

Table 1 : Test Samples

## 2 Performance Requirements

The RF performance requirements of the BtB connectors are specified as follows :

- Insertion Loss :      0.20dB up to 2.2 GHz  
                                 0.25dB up to 3.0 GHz
  
- Return Loss :         VSWR 1.2 up to 2.2 GHz  
                                 VSWR 1.3 up to 3.0 GHz

### 3 Measurement setup

#### 3.1 Measuring connectors with Network Analyzer

The network analyzer used for this measurement is an HP 8510.

Used frequency range : 50MHz – 20.05GHz

Number of points : 401

Sweep time :100ms

Averaging : 16

Calibration : Full 2-port calibration with calibration set HP85052D (3.5 mm calibration kit)

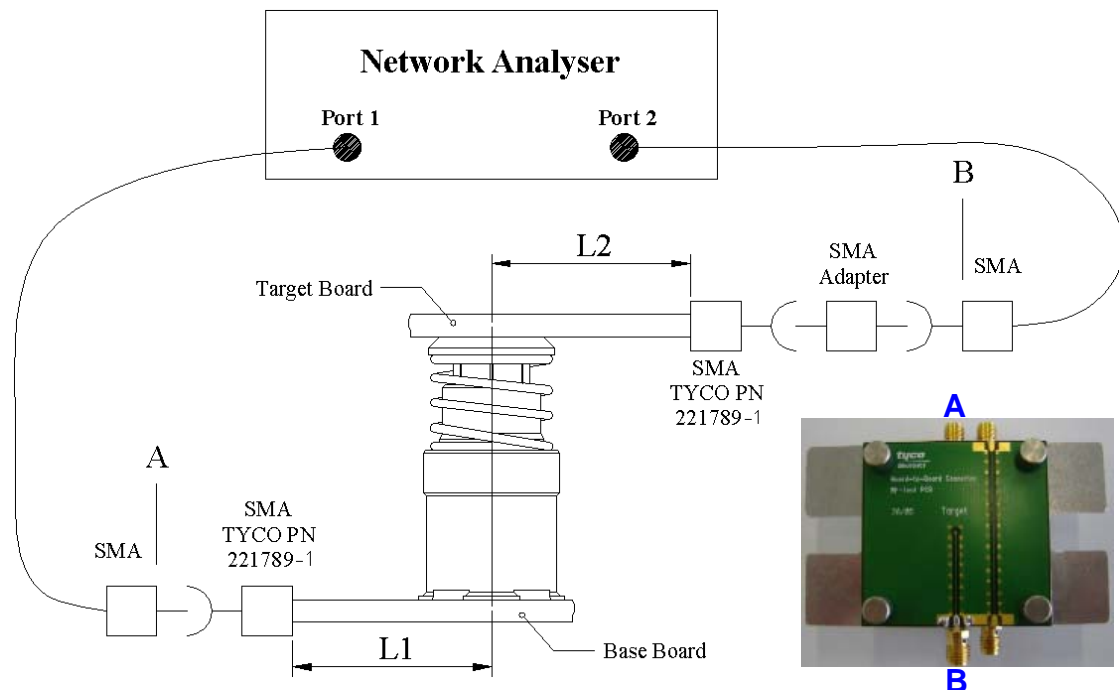

Figure 1 : Test setup

To deembed the connector from the setup (in reflection measurements), the gating option has been used. Both results, ungated and gated have been displayed.

For the insertion loss measurements, the PCB's and the SMA's are deembedded.

#### 3.2 Mounting conditions

The samples have been tested under the following mounting conditions:

- Base Board to Target Board distance:
  - o Minimal (9 mm)
  - o Nominal (10 mm)
  - o Maximal (11 mm)
- Board to board misalignment:
  - o Minimal (approx 0mm)
  - o Maximal (approx 0.5mm)
- Inclination between base and target board:
  - o Minimal (approx 0°)
  - o Maximal (approx. 2.8°)\*

\*The connector is designed to withstand an inclination of 2°.

## 4 Measurement Results

### 4.1 Gating procedure

To exclude the influence of the PCB board and the SMA connectors the gating option is used. In Figure 2 a typical impedance profile is shown with and without gating.

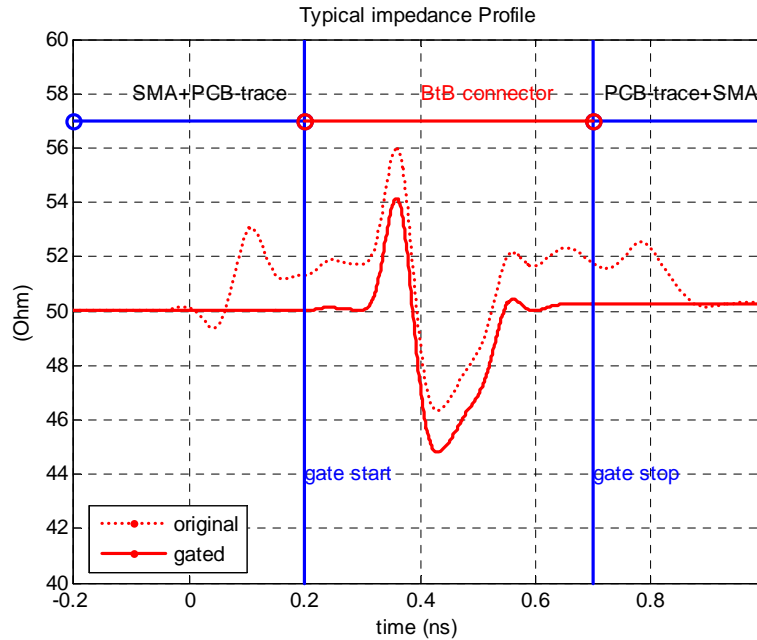

Figure 2 : Impedance Profile

Figure 3 shows the corresponding reflection.



Figure 3 : VSWR

## 4.2 Return Loss

### 4.2.1 At minimal misalignment

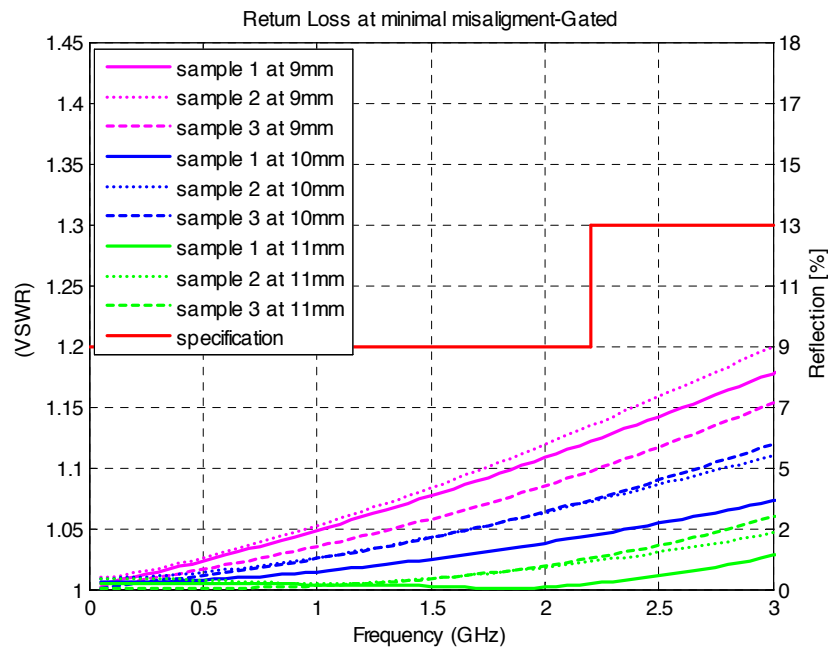

Figure 4 : Return Loss at minimum misalignment (Gated)

### 4.2.2 At maximal misalignment

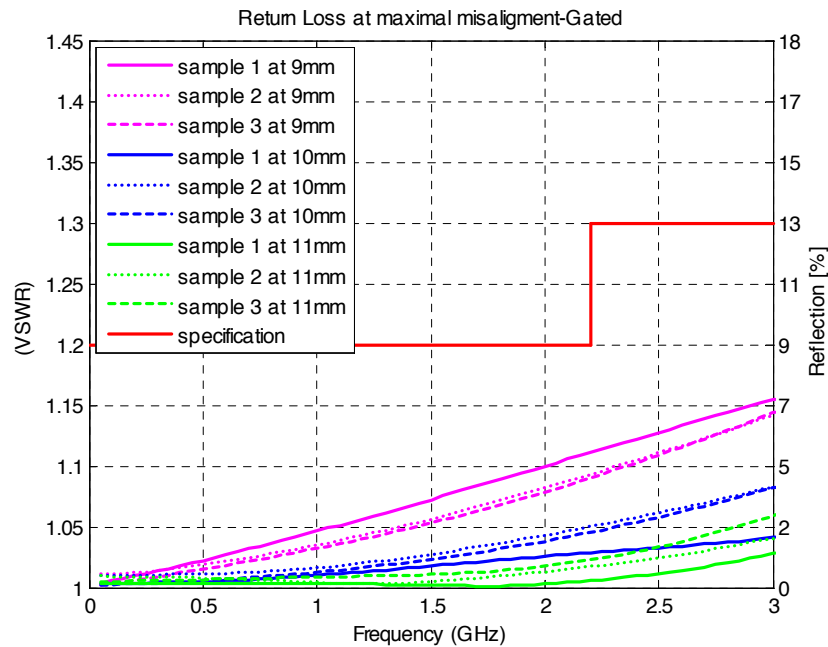

Figure 5 : Return Loss at maximum misalignment (Gated)

4.2.3 Influence of inclination

4.2.3.1 At minimal misalignment

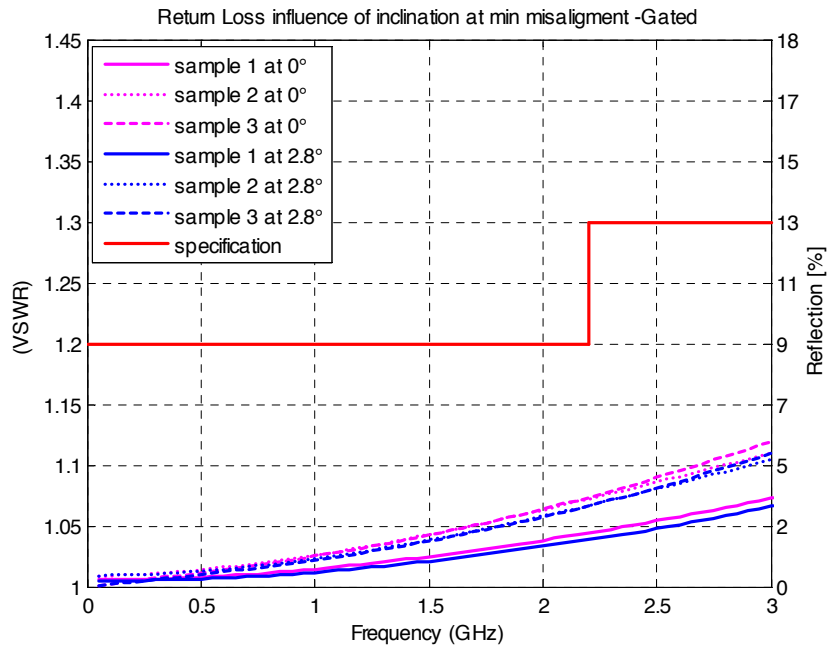

Figure 6 : Return Loss, influence of inclination at minimum misalignment (Gated)

4.2.3.2 At maximal misalignment

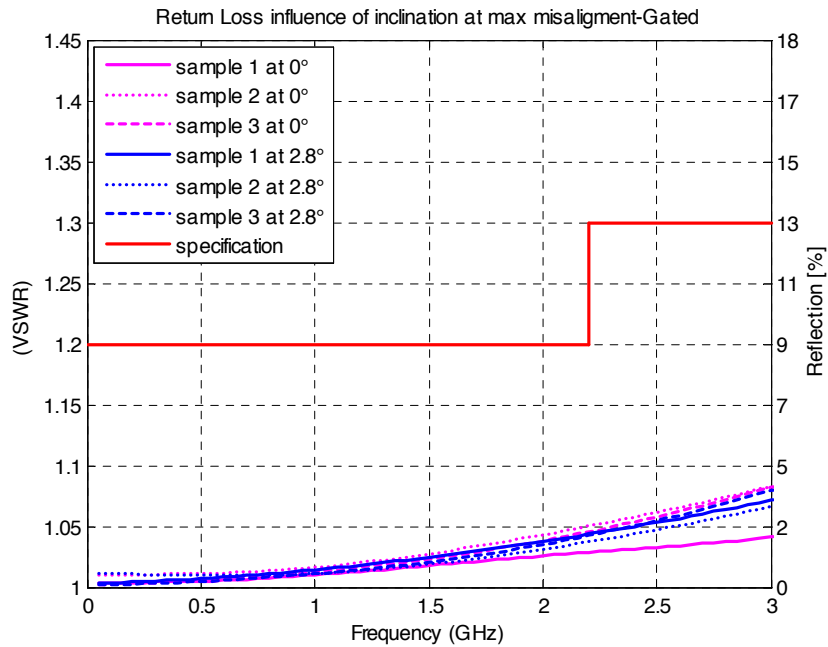

Figure 7 : Return Loss, influence of inclination at maximum misalignment (Gated)

### 4.3 Insertion Loss

#### 4.3.1 At minimal misalignment

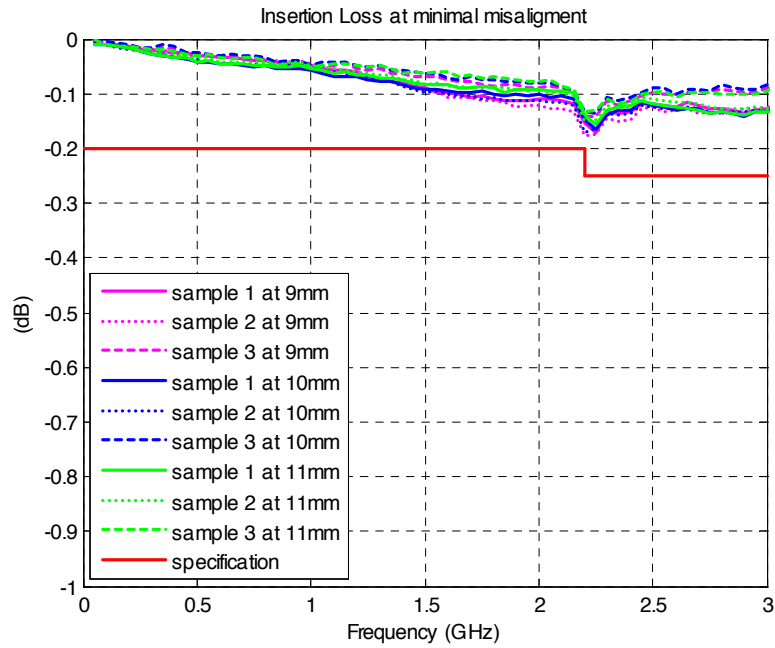

Figure 8 : Insertion Loss at minimum misalignment

#### 4.3.2 At maximal misalignment

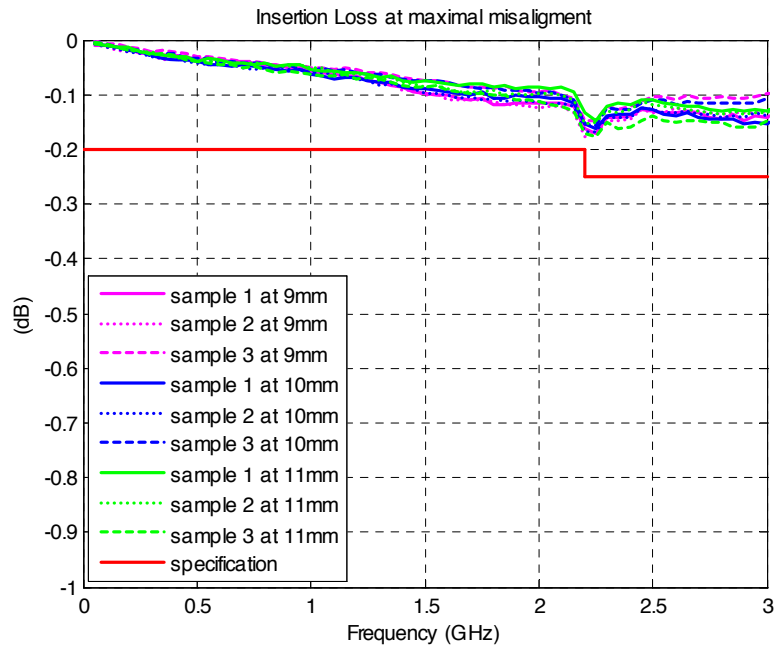

Figure 9 : Insertion Loss at maximum misalignment



### 4.3.3 Influence of inclination

#### 4.3.3.1 At minimal misalignment

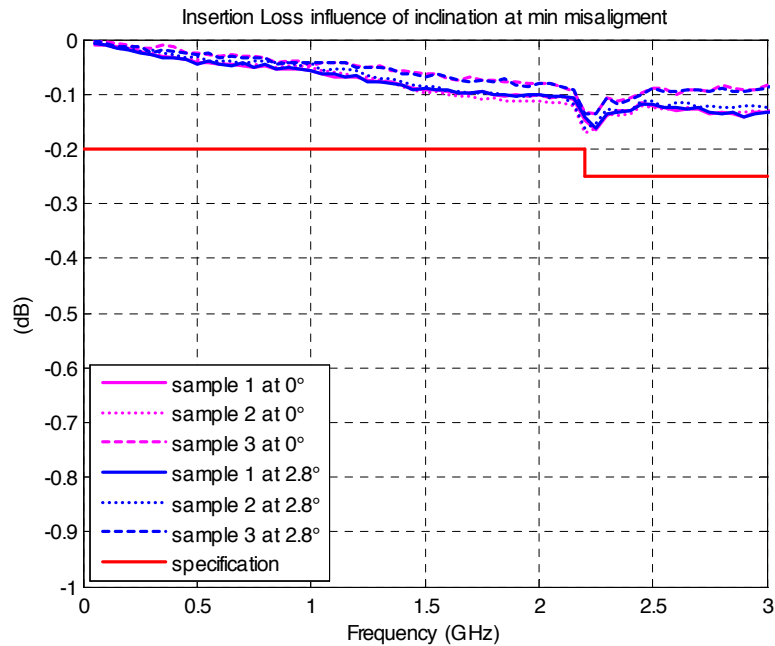

Figure 10 : Insertion, influence of inclination at minimum misalignment

#### 4.3.3.2 At maximal misalignment

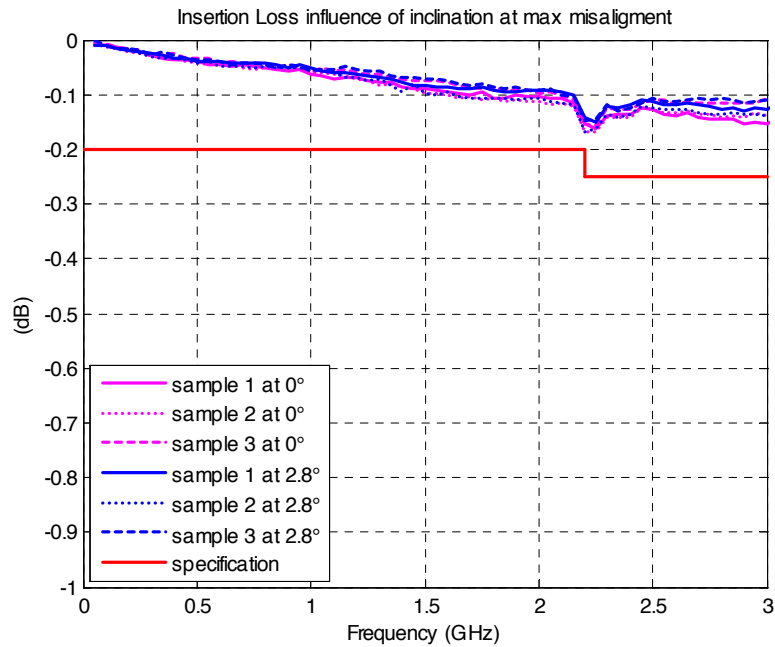

Figure 11 : Insertion Loss, influence of inclination at maximum misalignment

## 5 Conclusions

The 3 measured samples fulfill all requirements of return loss and insertion loss for all the tested conditions of alignment and inclination.

The influence of the alignment and inclination on the return and insertion loss is minor.