

ENERGIZER NO. E91

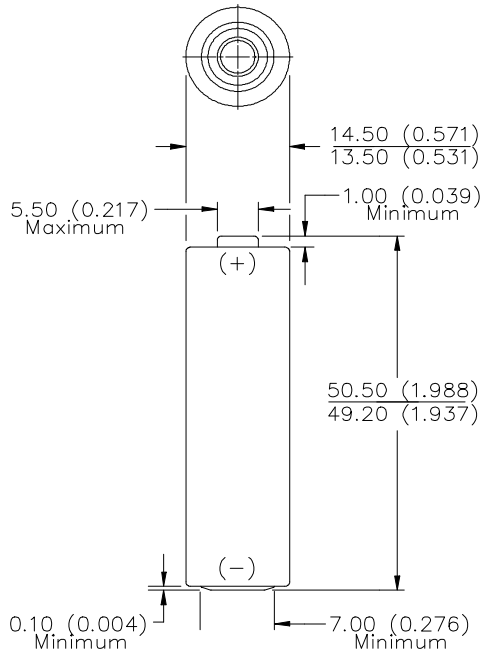

Industry Standard Dimensions in mm (inches)



AA

Chemical System: Alkaline
 Zinc-Manganese Dioxide (Zn/MnO₂)
 (No Added Mercury or Cadmium)

Designation: ANSI-15A, IEC-LR6

Battery Voltage: 1.5 Volts

Internal Resistance: 146 Milliohms (Fresh)

Operating Temp: -18°C to 55°C (0°F to 130°F)

Average Capacity: 2,850 mAh (to 0.8 volts)
 (Rated capacity at 25 mA continuous drain.)

Average Weight: 23.0 grams (0.8 oz.)

Volume: 8.1 cubic centimeters (0.5 cubic inch)

Cell: One No. 3-315 (size 'AA')

Jacket: Plastic Label

Shelf Life: 7 years (80% of rated capacity)

TEMPERATURE EFFECTS Typical Service to 0.8 Volts

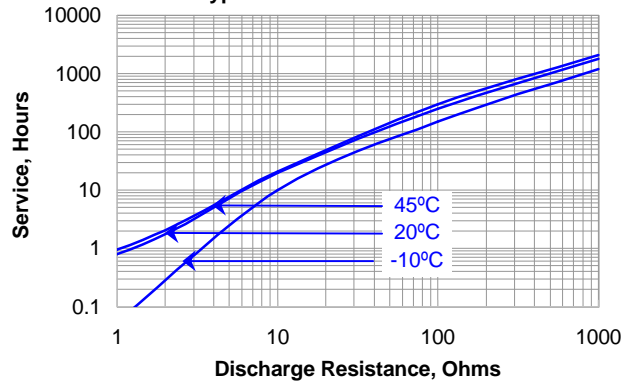

CONSTANT RESISTANCE PERFORMANCE Typical Service

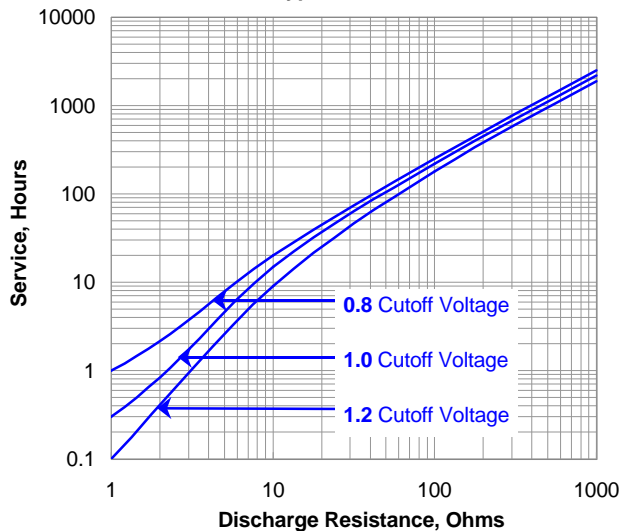

CONSTANT CURRENT DISCHARGE Typical Service

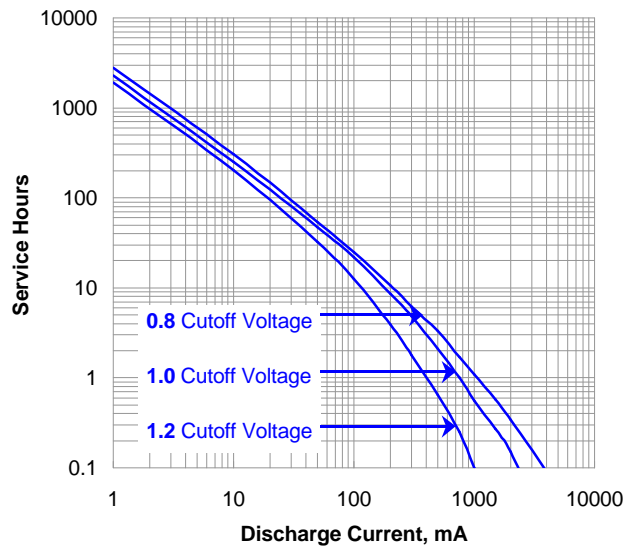

Important Notice

This data sheet contains information specific to batteries manufactured at the time of its publication.

Contents herein do not constitute a warranty.

Copyright © Eveready Battery Co. - All rights reserved

ENERGIZER NO. E91

CONSTANT POWER DISCHARGE
Typical Service

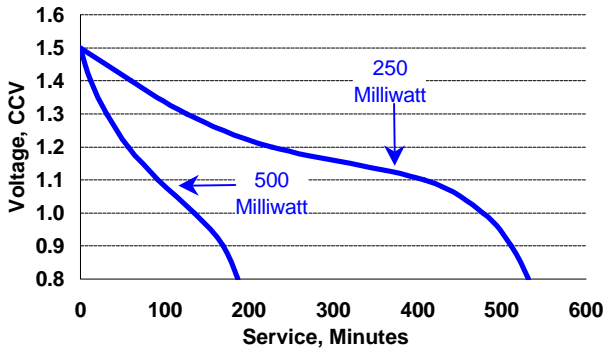

CONSTANT POWER DISCHARGE
Typical Service

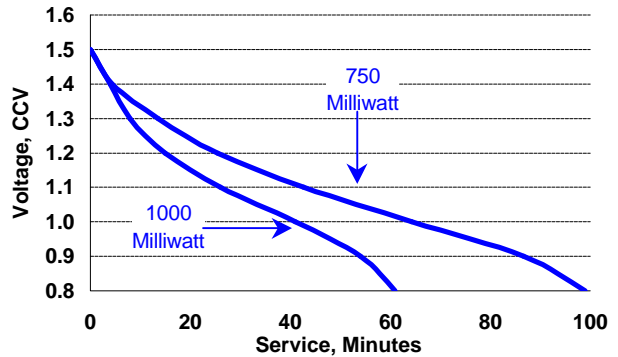

ANSI - IEC Industry Standard Tests @ 20° C

RADIO
43 ohm - 4 hours/day

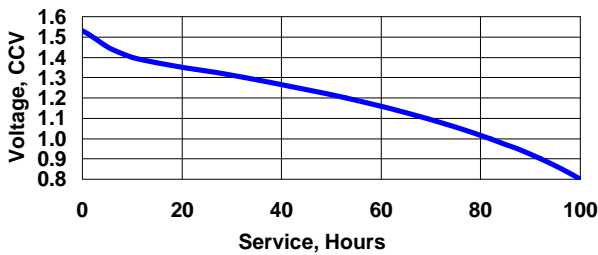

TOY
3.9 ohm - 1 hr/day

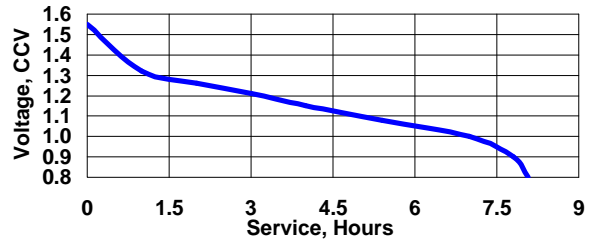

REMOTE
24 ohm - 15 spm - 8 hr/day

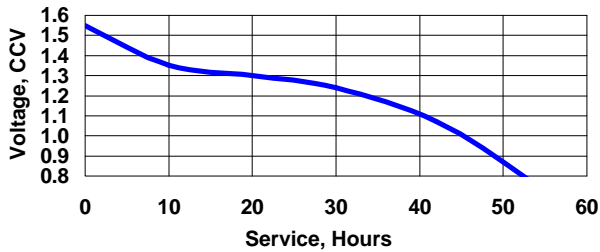

TAPE PLAYER
10 ohm - 1 hr/day

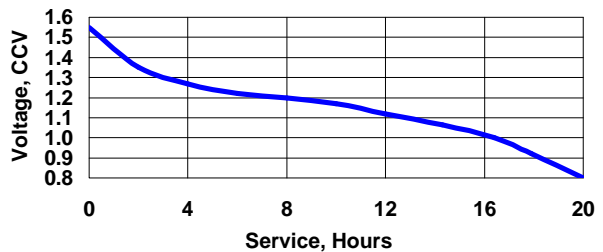

CD / MD / ELEC GAME
250 mA - 1 hr/day

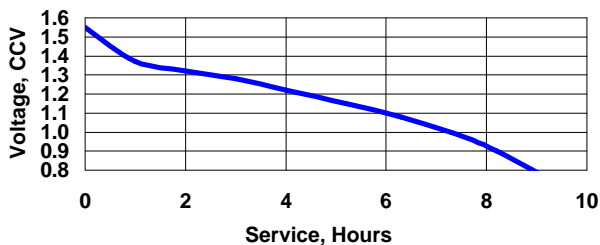

DIGITAL CAMERA
1000 mA-Cont

PHOTOFLASH
1000 m10sec/min
1 hr/day

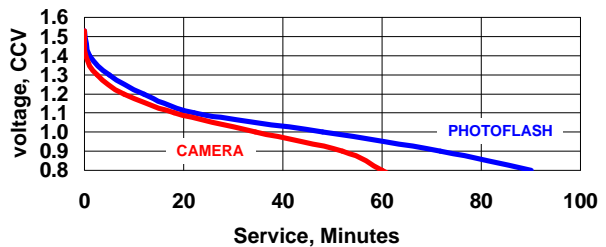

Important Notice

This data sheet contains information specific to batteries manufactured at the time of its publication.

Contents herein do not constitute a warranty.

Copyright © Eveready Battery Co. - All rights reserved