

10 9 8 7 6 5 4 3 2 1

回路番号

トレードマーク

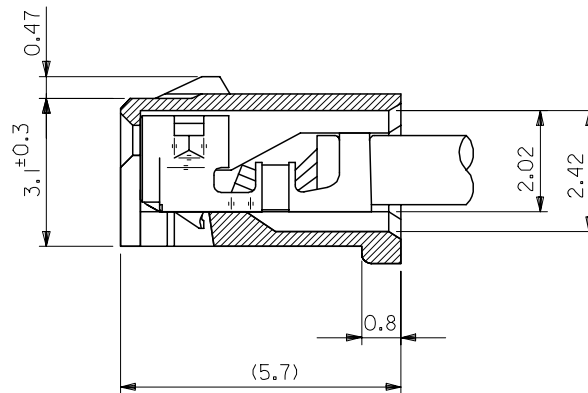
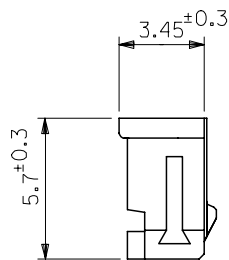
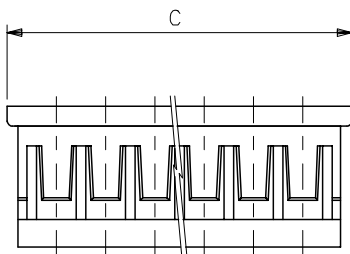
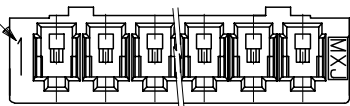

ターミナル装着状態図
(10:1)

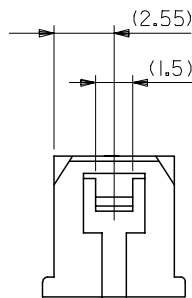
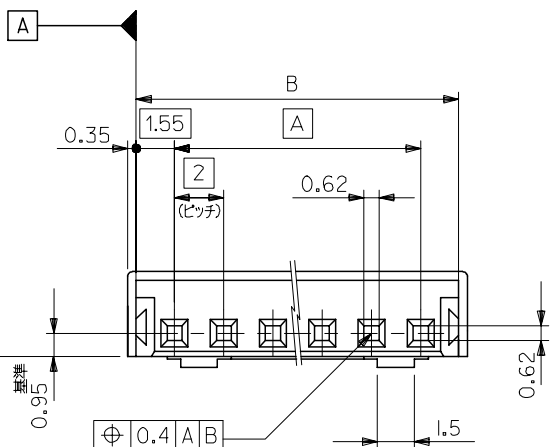

2極の場合

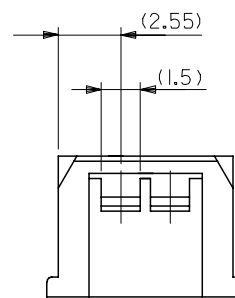

3極の場合

31.8	31.1	28	51065-150*	15
29.8	29.1	26	-140*	14
27.8	27.1	24	-130*	13
25.8	25.1	22	-120*	12
23.8	23.1	20	-110*	11
21.8	21.1	18	-100*	10
19.8	19.1	16	-090*	9
17.8	17.1	14	-080*	8
15.8	15.1	12	-070*	7
13.8	13.1	10	-060*	6
11.8	11.1	8	-050*	5
9.8	9.1	6	-040*	4
7.8	7.1	4	-030*	3
5.8	5.1	2	51065-020*	2
C	B	A	MATERIAL NO.	極数

注記

- 適合ターミナル：50212-8*00
- 嵌合相手：53253-***10,53254-***10
- 材質：PBT. UL94V-0
- MATERIAL NO. の説明

51065-***0*

- 製品の色
- 1:黒 (BLACK)
 - 5:灰 (GRAY)
 - 6:緑 (GREEN)
 - 7:茶 (BROWN)

REVISED EC NO: J2006-1395 DRWN:MABEI 2005/10/31 CHKDK:TOYODA 2005/11/01 APPR:NUKITA 2005/11/02	GENERAL TOLERANCES (UNLESS SPECIFIED)		DIMENSION STYLE MM ONLY		SCALE 5:1	DESIGN UNITS METRIC	THIRD ANGLE PROJECTION	
	10 UNDER	±0.2	DRAWN BY S. AIHARA	DATE '89/09/21	TITLE NEW 2.0 WIRE TO BOARD CONN RECEPTACLE HOUSING			
	10 OVER 30 UNDER	±0.25	CHECKED BY M. FUKUSHIMA	DATE '90/01/18	MATERIAL NO. SEE CHART			
	30 OVER	±0.3	APPROVED BY M. ENOMOTO	DATE '90/01/18	DOCUMENT NO. SD-51065-004			
ANGULAR ±3 °		DRAFT WHERE APPLICABLE MUST REMAIN WITHIN DIMENSIONS		SIZE A3		SHEET NO. 1 OF 2		

10 9 8 7 6 5 4 3 2 1

F

F

E

E

D

D

C

C

B

B

A

A

31.8	31.1	28	51065-1507	51065-1506	51065-1505	51065-1501	51065-1500	15
29.8	29.1	26	51065-1407	51065-1406	51065-1405	51065-1401	51065-1400	14
27.8	27.1	24	51065-1307		51065-1305	51065-1301	51065-1300	13
25.8	25.1	22	51065-1207	51065-1206	51065-1205	51065-1201	51065-1200	12
23.8	23.1	20	51065-1107		51065-1105	51065-1101	51065-1100	11
21.8	21.1	18	51065-1007	51065-1006	51065-1005	51065-1001	51065-1000	10
19.8	19.1	16	51065-0907	51065-0906	51065-0905	51065-0901	51065-0900	9
17.8	17.1	14	51065-0807	51065-0806	51065-0805	51065-0801	51065-0800	8
15.8	15.1	12	51065-0707		51065-0705	51065-0701	51065-0700	7
13.8	13.1	10	51065-0607		51065-0605	51065-0601	51065-0600	6
11.8	11.1	8	51065-0507		51065-0505	51065-0501	51065-0500	5
9.8	9.1	6	51065-0407		51065-0405	51065-0401	51065-0400	4
7.8	7.1	4	51065-0307		51065-0305		51065-0300	3
5.8	5.1	2	51065-0207		51065-0205		51065-0200	2
C	B	A	BROWN	GREEN	GRAY	BLACK	NATURAL	極数

REVISED EC NO: J2006-1395 DRWN: NABE 2005/10/31 CHKDK: TOYODA 2005/11/01 APPR: NUKITA 2005/11/02	GENERAL TOLERANCES (UNLESS SPECIFIED)		DIMENSION STYLE MM ONLY		SCALE 5:1	DESIGN UNITS METRIC	THIRD ANGLE PROJECTION		
	10 UNDER	± 0.2	DRAWN BY S. AIHARA		DATE '89/09/21		TITLE NEW 2.0 WIRE TO BOARD CONN RECEPTACLE HOUSING		
	10 OVER 30 UNDER	± 0.25	CHECKED BY M. FUKUSHIMA		DATE '90/01/18				
	30 OVER	± 0.3	APPROVED BY M. ENOMOTO		DATE '90/01/18		MOLEX INCORPORATED		
	ANGULAR	± 3 °	MATERIAL NO. SEE CHART		DOCUMENT NO. SD-51065-004		SHEET NO. 2 OF 2		
DRAFT WHERE APPLICABLE MUST REMAIN WITHIN DIMENSIONS		SIZE A3		THIS DRAWING CONTAINS INFORMATION THAT IS PROPRIETARY TO MOLEX INCORPORATED AND SHOULD NOT BE USED WITHOUT WRITTEN PERMISSION					

9

8

7

6

5

4

3

2

CIRCUIT NO.

TRADE MARK

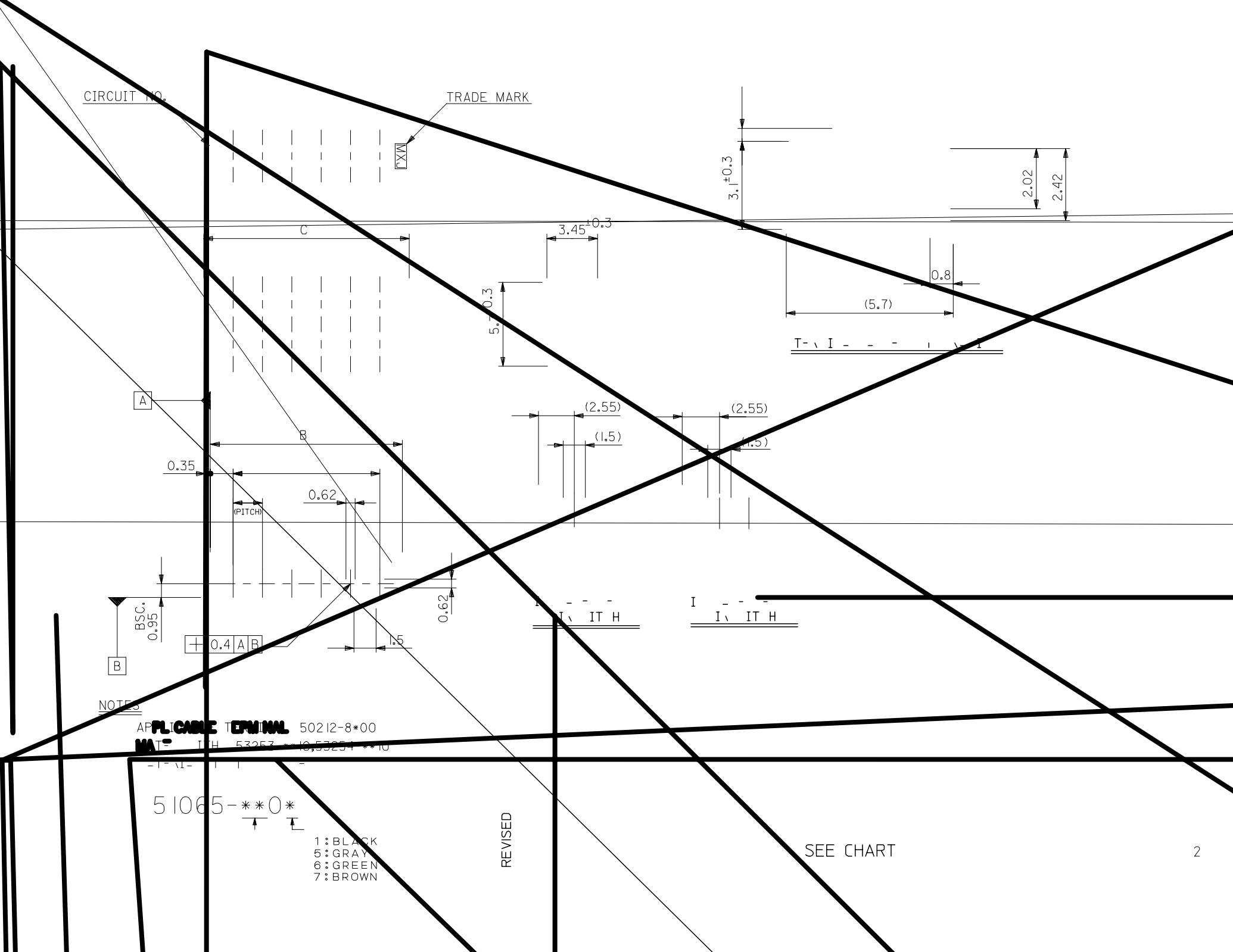

A

B

B

0.4 A | B

NOTES

APPLICABLE TERMINAL 50212-8*00

DATE 10/53253 **10,53254 **10

51065-***0*

- 1: BLACK
- 5: GRAY
- 6: GREEN
- 7: BROWN

REVISED

SEE CHART

10 9 8 7 6 5 4 3 2 1

F

F

E

E

D

D

C

C

B

B

A

A

31.8	31.1	28	51065-1507	51065-1506	51065-1505	51065-1501	51065-1500	15
29.8	29.1	26	51065-1407	51065-1406	51065-1405	51065-1401	51065-1400	14
27.8	27.1	24	51065-1307		51065-1305	51065-1301	51065-1300	13
25.8	25.1	22	51065-1207	51065-1206	51065-1205	51065-1201	51065-1200	12
23.8	23.1	20	51065-1107		51065-1105	51065-1101	51065-1100	11
21.8	21.1	18	51065-1007	51065-1006	51065-1005	51065-1001	51065-1000	10
19.8	19.1	16	51065-0907	51065-0906	51065-0905	51065-0901	51065-0900	9
17.8	17.1	14	51065-0807	51065-0806	51065-0805	51065-0801	51065-0800	8
15.8	15.1	12	51065-0707		51065-0705	51065-0701	51065-0700	7
13.8	13.1	10	51065-0607		51065-0605	51065-0601	51065-0600	6
11.8	11.1	8	51065-0507		51065-0505	51065-0501	51065-0500	5
9.8	9.1	6	51065-0407		51065-0405	51065-0401	51065-0400	4
7.8	7.1	4	51065-0307		51065-0305		51065-0300	3
5.8	5.1	2	51065-0207		51065-0205		51065-0200	2
C	B	A	BROWN	GREEN	GRAY	BLACK	NATURAL	極数

MATERIAL NO.

REVISED EC NO: J2006-1395 DRAWN: NABE 2005/10/31 CHKD: KTOYODA 2005/11/01 APPR: NUKITA 2005/11/02	GENERAL TOLERANCES (UNLESS SPECIFIED)		DRAWN BY		DATE	TITLE	THIRD ANGLE PROJECTION
	10 UNDER	± 0.2	CHECKED BY		DATE	NEW 2.0 WIRE TO BOARD CONN RECEPTACLE HOUSING	
	10 OVER 30 UNDER	± 0.25	APPROVED BY		DATE		MOLEX INCORPORATED
	30 OVER	± 0.3	SEE CHART		SD-510b	2	
REV	DRAFT WHERE APPLICABLE MUST REMAIN WITHIN DIMENSIONS		A3				

