

Low Current SMD LED

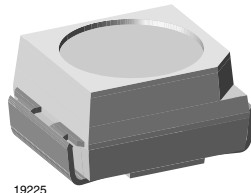

19225

DESCRIPTION

These new devices have been designed to meet the increasing demand for AlInGaP based low current SMD LEDs.

The package of the VLM.30.. is the PLCC-2 package. It consists of a lead frame which is embedded in a white thermoplast. The reflector inside this package is filled up with clear epoxy.

FEATURES

- SMD LED with exceptional brightness
- Compatible with automatic placement equipment
- EIA and ICE standard package
- Compatible with IR-Reflow, vapor phase and wave solder processes according to CECC 00802 and J-STD-020C
- Available in 8 mm tape
- Low profile package
- Non-diffused lens: excellent for coupling to light pipes and backlighting
- Very low power consumption
- Luminous intensity ratio in one packaging unit $I_{Vmax}/I_{Vmin} \leq 2.0$
- ESD withstand voltage: up to 2 kV according to JESD22-A114-B
- Lead (Pb)-free device
- Preconditioning: according to JEDEC Level 2a
- Component in accordance to RoHS 2002/95/EC and WEEE 2002/96/EC



APPLICATIONS

- Automotive: Backlighting in dashboards and switches
- Telecommunication: Indicator and backlighting in telephone and fax
- Indicator and backlight for audio and video equipment
- Indicator and backlight for battery driven equipment
- Indicator and backlight in office equipment
- Flat backlight for LCDs, switches and symbols
- General use

PARTS TABLE

PART	COLOR, LUMINOUS INTENSITY	ANGLE OF HALF INTENSITY (± 9)	TECHNOLOGY
VLMS3000-GS08/VLMS3000-GS18	Superred, $I_V > 2.8$ mcd	60°	AllnGaP
VLMS30J1K2-GS08/VLMS30J1K2-GS18	Superred, $I_V = (4.5 - 11.2)$ mcd	60°	AllnGaP
VLMS30K1L2-GS08/VLMS30K1L2-GS18	Superred, $I_V = (7.1 - 18)$ mcd	60°	AllnGaP
VLMS30J1L2-GS08/VLMS30J1L2-GS18	Superred, $I_V = (4.5 - 18)$ mcd	60°	AllnGaP
VLMS30J2K2-GS08/VLMS30J2K2-GS18	Superred, $I_V = (5.6 - 11.2)$ mcd	60°	AllnGaP
VLMO3000-GS08/VLMO3000-GS18	Orange, $I_V > 5.6$ mcd	60°	AllnGaP
VLMO30K1L2-GS08/VLMO30K1L2-GS18	Orange, $I_V = (7.1 - 18)$ mcd	60°	AllnGaP
VLMO30L1M2-GS08/VLMO30L1M2-GS18	Orange, $I_V = (11.2 - 28)$ mcd	60°	AllnGaP
VLMO30K1M2-GS08/VLMO30K1M2-GS18	Orange, $I_V = (7.1 - 28)$ mcd	60°	AllnGaP
VLMY3000-GS08/VLMY3000-GS18	Yellow, $I_V > 4.5$ mcd	60°	AllnGaP
VLMY3001GS08/VLMY3001-GS18	Yellow, $I_V = (7.1 - 18)$ mcd	60°	AllnGaP
VLMY30J2L1-GS08/VLMY30J2L1-GS18	Yellow, $I_V = (5.6 - 14)$ mcd	60°	AllnGaP
VLMY30K2M1-GS08/VLMY30K2M1-GS18	Yellow, $I_V = (9 - 22.4)$ mcd	60°	AllnGaP
VLMY30J2M1-GS08/VLMY30J2M1-GS18	Yellow, $I_V = (5.6 - 22.4)$ mcd	60°	AllnGaP

ABSOLUTE MAXIMUM RATINGS¹⁾, VLM30..				
PARAMETER	TEST CONDITION	SYMBOL	VALUE	UNIT
Reverse voltage ²⁾		V_R	6	V
DC Forward current		I_F	15	mA
Surge forward current	$t_p \leq 10 \mu s$	I_{FSM}	0.1	A
Power dissipation		P_V	40	mW
Junction temperature		T_j	125	°C
Operating temperature range		T_{amb}	- 40 to + 100	°C
Storage temperature range		T_{stg}	- 40 to + 100	°C
Thermal resistance junction/ ambient	mounted on PC board (pad size > 16 mm ²)	R_{thJA}	400	K/W

Note:

- 1) $T_{amb} = 25 \text{ }^\circ\text{C}$, unless otherwise specified
- 2) Driving the LED in reverse direction is suitable for short term application

OPTICAL AND ELECTRICAL CHARACTERISTICS¹⁾, RED, VLMS30..							
PARAMETER	TEST CONDITION	PART	SYMBOL	MIN	TYP.	MAX	UNIT
Luminous intensity ²⁾	$I_F = 2 \text{ mA}$	VLMS3000	I_V	2.8			mcd
	$I_F = 10 \text{ mA}$	VLMS3000	I_V		20		mcd
	$I_F = 2 \text{ mA}$	VLMS30J1K2	I_V	4.5		11.2	mcd
	$I_F = 2 \text{ mA}$	VLMS30K1L2	I_V	7.1		18	mcd
	$I_F = 2 \text{ mA}$	VLMS30J1L2	I_V	4.5		18	mcd
	$I_F = 2 \text{ mA}$	VLMS30J2K2	I_V	5.6		11.2	mcd
Dominant wavelength	$I_F = 2 \text{ mA}$		λ_d	624		636	nm
Peak wavelength	$I_F = 2 \text{ mA}$		λ_p		635		nm
Angle of half intensity	$I_F = 2 \text{ mA}$		ϕ		± 60		deg
Forward voltage	$I_F = 2 \text{ mA}$		V_F		1.8	2.2	V
Reverse voltage	$I_R = 10 \mu\text{A}$		V_R	6	15		V

Note:

- 1) $T_{amb} = 25 \text{ }^\circ\text{C}$, unless otherwise specified
- 2) In one Packing Unit $I_{Vmax}/I_{Vmin} \leq 2.0$

OPTICAL AND ELECTRICAL CHARACTERISTICS¹⁾, ORANGE, VLMO30..							
PARAMETER	TEST CONDITION	PART	SYMBOL	MIN	TYP.	MAX	UNIT
Luminous intensity ²⁾	$I_F = 2 \text{ mA}$	VLMO3000	I_V	5.6			mcd
	$I_F = 10 \text{ mA}$	VLMO3000	I_V		50		mcd
	$I_F = 2 \text{ mA}$	VLMO30K1L2	I_V	7.1		18	mcd
	$I_F = 2 \text{ mA}$	VLMO30L1M2	I_V	11.2		28	mcd
	$I_F = 2 \text{ mA}$	VLMO30K1M2	I_V	7.1		28	mcd
Dominant wavelength	$I_F = 2 \text{ mA}$		λ_d	600		609	nm
Peak wavelength	$I_F = 2 \text{ mA}$		λ_p		610		nm
Angle of half intensity	$I_F = 2 \text{ mA}$		ϕ		± 60		deg
Forward voltage	$I_F = 2 \text{ mA}$		V_F		1.8	2.2	V
Reverse voltage	$I_R = 10 \mu\text{A}$		V_R	6	15		V

Note:

- 1) $T_{amb} = 25 \text{ }^\circ\text{C}$, unless otherwise specified
- 2) In one Packing Unit $I_{Vmax}/I_{Vmin} \leq 2.0$



OPTICAL AND ELECTRICAL CHARACTERISTICS¹⁾, YELLOW, VLMY30..							
PARAMETER	TEST CONDITION	PART	SYMBOL	MIN	TYP.	MAX	UNIT
Luminous intensity ²⁾	$I_F = 2 \text{ mA}$	VLMY3000	I_V	4.5			mcd
	$I_F = 10 \text{ mA}$	VLMY3000	I_V		50		mcd
	$I_F = 10 \text{ mA}$	VLMY3001	I_V	7.1		18	mcd
	$I_F = 2 \text{ mA}$	VLMY30J2L1	I_V	5.6		14	mcd
	$I_F = 2 \text{ mA}$	VLMY30K2M1	I_V	9		22.4	mcd
	$I_F = 2 \text{ mA}$	VLMY30J2M1	I_V	5.6		22.4	mcd
Dominant wavelength	$I_F = 2 \text{ mA}$		λ_d	581		594	nm
Peak wavelength	$I_F = 2 \text{ mA}$		λ_p		585		nm
Angle of half intensity	$I_F = 2 \text{ mA}$		ϕ		± 60		deg
Forward voltage	$I_F = 2 \text{ mA}$		V_F		1.8	2.2	V
Reverse voltage	$I_R = 10 \mu\text{A}$		V_R	6	15		V

Note:

- 1) $T_{amb} = 25 \text{ }^\circ\text{C}$, unless otherwise specified
- 2) In one Packing Unit $I_{Vmax}/I_{Vmin} \leq 2.0$

LUMINOUS INTENSITY CLASSIFICATION			
GROUP	LIGHT INTENSITY (MCD)		
STANDARD	OPTIONAL	MIN.	MAX.
H	1	2.8	3.55
	2	3.55	4.5
J	1	4.5	5.6
	2	5.6	7.1
K	1	7.1	9.0
	2	9.0	11.2
L	1	11.2	14.0
	2	14.0	18.0
M	1	18.0	22.4
	2	22.4	28.0

Note:

Luminous Intensity is tested at a current pulse duration of 25 ms and an accuracy of $\pm 11 \%$. The above type numbers represent the order groups which include only a few brightness groups. Only one group will be shipped in one reel (there will be no mixing of two groups on each reel). In order to ensure availability, single brightness groups will not be orderable. In a similar manner for colors where wavelength groups are measured and binned, single wavelength groups will be shipped in any one reel. In order to ensure availability, single wavelength groups will not be orderable.

COLOR CLASSIFICATION				
GROUP	YELLOW		ORANGE	
	DOM. WAVELENGTH (NM)			
	MIN.	MAX.	MIN.	MAX.
1	581	584		
2	583	586	600	603
3	585	588	602	605
4	587	590	604	607
5	589	592	606	609
6	591	594		

Note:

Wavelengths are tested at a current pulse duration of 25 ms and an accuracy of $\pm 1 \text{ nm}$.

CROSSING TABLE	
VISHAY	OSRAM
VLMO30K1L2	LOT67K-K1L2
VLMO30K1M2	LOT67K-K1M2
VLMO30L1M2	LOT67K-L1M2
VLMS30J1K2	LST67K-J1K2
VLMS30J1L2	LST67K-J1L2
VLMS30K1L2	LST67K-K1L2
VLMY30J2L1	LYT67K-J2L1
VLMY30J2M1	LYT67K-J2M1
VLMY30K2M1	LYT67K-K2M1

TYPICAL CHARACTERISTICS

$T_{amb} = 25\text{ }^{\circ}\text{C}$ unless otherwise specified

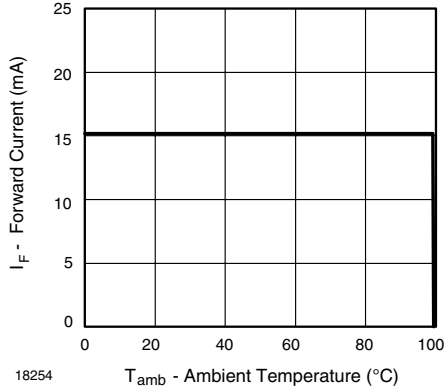

18254
Figure 1. Forward Current vs. Ambient Temperature

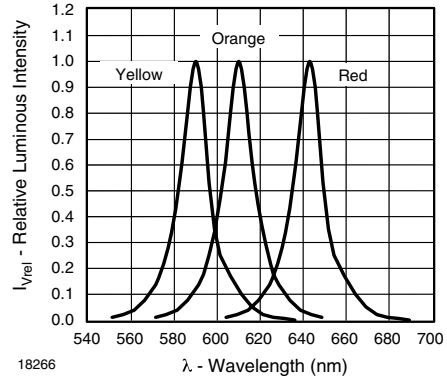

18266
Figure 4. Relative Intensity vs. Wavelength

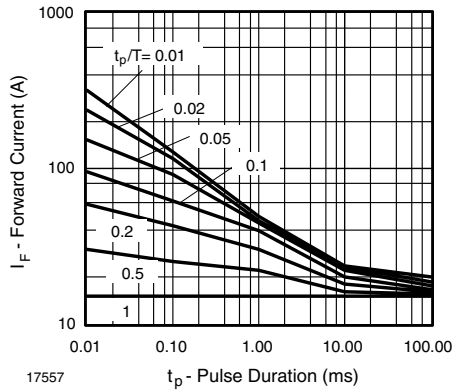

17557
Figure 2. Forward Current vs. Pulse Length

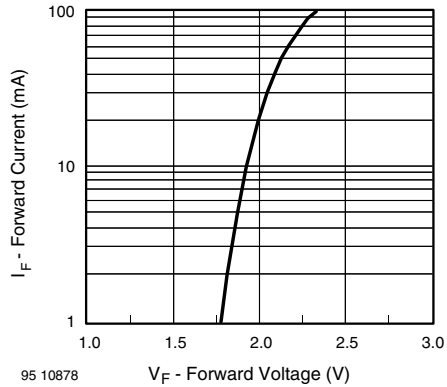

95 10878
Figure 5. Forward Current vs. Forward Voltage

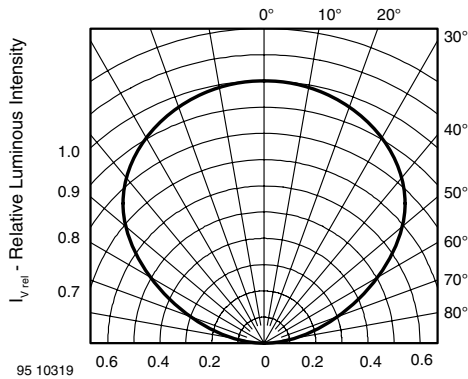

95 10319
Figure 3. Rel. Luminous Intensity vs. Angular Displacement

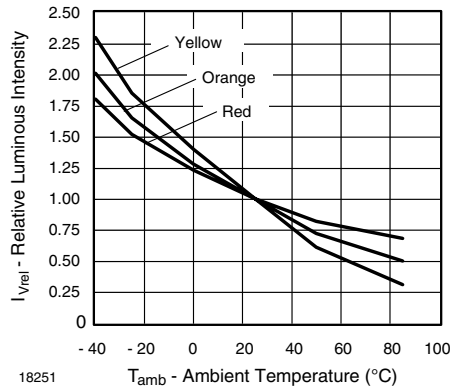

18251
Figure 6. Rel. Luminous Intensity vs. Ambient Temperature

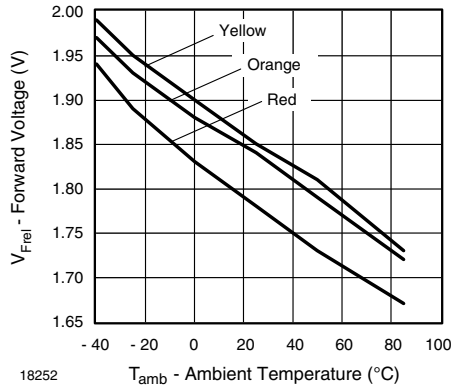
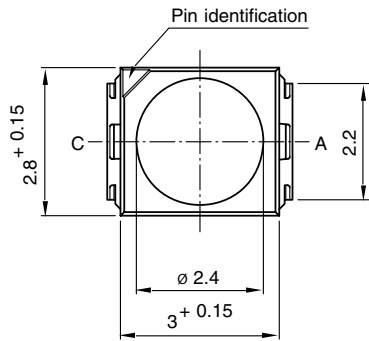
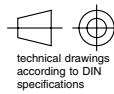
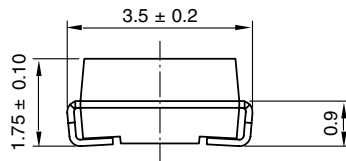

Figure 7. Forward Voltage vs. Ambient Temperature

PACKAGE DIMENSIONS IN MM



Drawing-No. : 6.541-5025.01-4
Issue: 8; 22.11.05

95 11314-1

Mounting Pad Layout

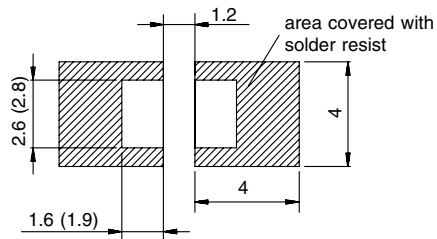

Dimensions: IR Reflow and Vaporphase
(Wave Soldering)

METHOD OF TAPING/POLARITY AND TAPE AND REEL

SMD LED (VLM.3 - SERIES)

Vishay's LEDs in SMD packages are available in an antistatic 8 mm blister tape (in accordance with DIN IEC 40 (CO) 564) for automatic component insertion. The blister tape is a plastic strip with impressed component cavities, covered by a top tape.

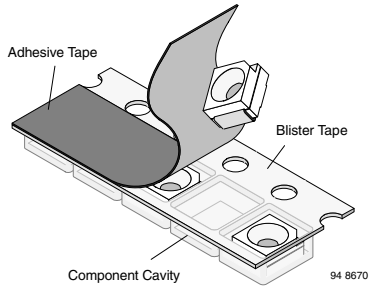

REEL PACKAGE DIMENSION IN MM FOR SMD LEDs, TAPE OPTION GS08 (= 1500 PCS.)

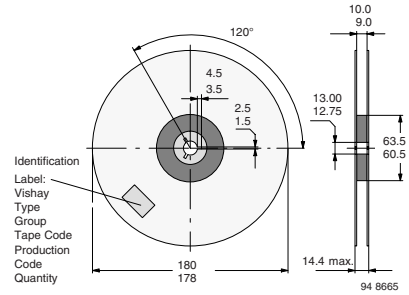

Figure 9. Reel dimensions - GS08

TAPING OF VLM.3...

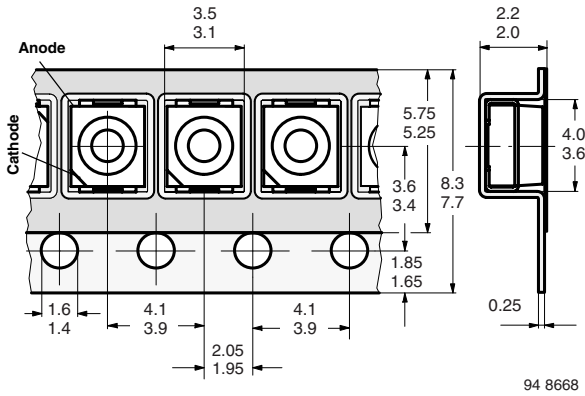

Figure 8. Tape dimensions in mm for PLCC-2

REEL PACKAGE DIMENSION IN MM FOR SMD LEDs, TAPE OPTION GS18 (= 8000 PCS.) PREFERRED

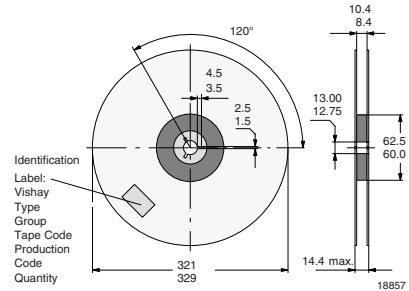

Figure 10. Reel dimensions - GS18

SOLDERING PROFILE

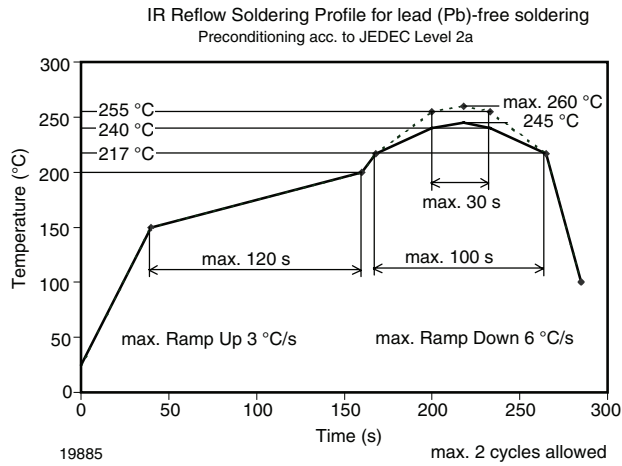

Figure 11. Vishay Lead (Pb)-free Reflow Soldering Profile (acc. to J-STD-020C)

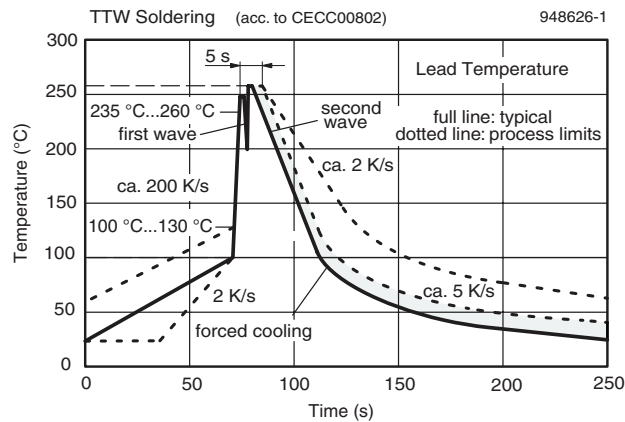
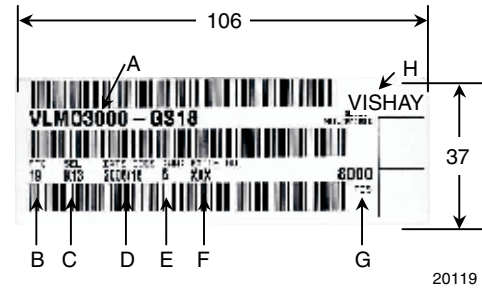

Figure 12. Double wave soldering of opto devices (all packages)

BARCODE-PRODUCT-LABEL EXAMPLE:



- A) Type of component
- B) Manufacturing Plant
- C) SEL - Selection Code (Bin):
e.g.: K1 = Code for Luminous Intensity Group
3 = Code for Color Group
- D) Date Code year/week
- E) Day Code (e.g. 5: Friday)
- F) Batch No.
- G) Total quantity
- H) Company Code

Ozone Depleting Substances Policy Statement

It is the policy of Vishay Semiconductor GmbH to

1. Meet all present and future national and international statutory requirements.
2. Regularly and continuously improve the performance of our products, processes, distribution and operating systems with respect to their impact on the health and safety of our employees and the public, as well as their impact on the environment.

It is particular concern to control or eliminate releases of those substances into the atmosphere which are known as ozone depleting substances (ODSs).

The Montreal Protocol (1987) and its London Amendments (1990) intend to severely restrict the use of ODSs and forbid their use within the next ten years. Various national and international initiatives are pressing for an earlier ban on these substances.

Vishay Semiconductor GmbH has been able to use its policy of continuous improvements to eliminate the use of ODSs listed in the following documents.

1. Annex A, B and list of transitional substances of the Montreal Protocol and the London Amendments respectively
2. Class I and II ozone depleting substances in the Clean Air Act Amendments of 1990 by the Environmental Protection Agency (EPA) in the USA
3. Council Decision 88/540/EEC and 91/690/EEC Annex A, B and C (transitional substances) respectively.

Vishay Semiconductor GmbH can certify that our semiconductors are not manufactured with ozone depleting substances and do not contain such substances.

We reserve the right to make changes to improve technical design
and may do so without further notice.

Parameters can vary in different applications. All operating parameters must be validated for each customer application by the customer. Should the buyer use Vishay Semiconductors products for any unintended or unauthorized application, the buyer shall indemnify Vishay Semiconductors against all claims, costs, damages, and expenses, arising out of, directly or indirectly, any claim of personal damage, injury or death associated with such unintended or unauthorized use.

Vishay Semiconductor GmbH, P.O.B. 3535, D-74025 Heilbronn, Germany



Notice

Specifications of the products displayed herein are subject to change without notice. Vishay Intertechnology, Inc., or anyone on its behalf, assumes no responsibility or liability for any errors or inaccuracies.

Information contained herein is intended to provide a product description only. No license, express or implied, by estoppel or otherwise, to any intellectual property rights is granted by this document. Except as provided in Vishay's terms and conditions of sale for such products, Vishay assumes no liability whatsoever, and disclaims any express or implied warranty, relating to sale and/or use of Vishay products including liability or warranties relating to fitness for a particular purpose, merchantability, or infringement of any patent, copyright, or other intellectual property right.

The products shown herein are not designed for use in medical, life-saving, or life-sustaining applications. Customers using or selling these products for use in such applications do so at their own risk and agree to fully indemnify Vishay for any damages resulting from such improper use or sale.