

Power Relay RM 2/3/7

- 2 / 3 pole 10 / 16 A, 2 CO or 3 CO contacts
- Switching capacity up to 6000 VA
- DC- or AC-coil
- Mechanical indicator
- Push-to-test-button
- Plug-in version, PCB terminals, chassis- or DIN-rail mount
- RoHS compliant (Directive 2002/95/EC) as per product date code 0415



F0163-A

Applications

Elevator control, power supplies

Approvals

VDE REG.-Nr. 40003144, **UL** E214025
Technical data of approved types on request

| Contact data | RM2 | RM3 | RM7 |
|--------------------------------------------------|---------------------------|---------|---------|
| Contact configuration | 2 CO | 3 CO | 3 CO |
| Contact set | single contact | | |
| Type of interruption | micro disconnection | | |
| Rated current | 16 A | 10 A | 16 A |
| Rated voltage / max.switching voltage AC | 400/440 VAC | | |
| Maximum breaking capacity AC | 6000 VA | 3800 VA | 6000 VA |
| Limiting making capacity, max 20 ms | 40 A | 40 A | 40 A |
| Contact material | AgCdO | | |
| Mechanical endurance | 20x10 ⁶ cycles | | |
| Rated frequency of operation with / without load | 16/100 min ⁻¹ | | |

Contact ratings

| Type | Load | Cycles |
|------|--------------------------------------------------|---------------------|
| RM2 | 16 A, 415 VAC, UL | 100x10 ³ |
| RM20 | 16 A, 400 VAC, cosφ=1, 35°C, VDE | 100x10 ³ |
| RM2 | 16 A, 250 VAC, general purpose, UL | 30x10 ³ |
| RM20 | 10 A, 48 VDC, UL | 30x10 ³ |
| RM30 | 10 A, 400 VAC, cosφ=1, 35°C, VDE | 100x10 ³ |
| RM3 | 10 A, 300 VAC, resistive, UL | 100x10 ³ |
| RM3 | 10 A, 250 VAC, general purpose, UL | 30x10 ³ |
| RM7 | 5 A, 400 VAC, resistive, UL | 100x10 ³ |
| RM70 | 16 A, 400 VAC, cosφ=1, 35°C, VDE | 100x10 ³ |
| RM7 | 10 A, 300 VAC, resistive, UL | 100x10 ³ |
| RM7 | 10 A, 415 VAC, 10% duty cycle, NO, 70°C, DC-coil | 100x10 ³ |

| Coil data | RM2 | RM3 | RM7 |
|----------------------------------|-------------|--------|--------|
| Rated coil voltage range DC coil | 6...220 VDC | | |
| AC coil | 6...400 VAC | | |
| Coil power DC coil | 1.2 W | 1.2 W | 1.6 W |
| AC coil | 2.3 VA | 2.3 VA | 2.8 VA |
| Operative range | 1 | | |

Coil versions, DC-coil

| Coil code | Rated voltage VDC | Operate voltage VDC | Release voltage VDC | Coil resistance Ohm | Rated coil power W |
|---------------------|-------------------|---------------------|---------------------|---------------------|--------------------|
| STD LED PD* bipolar | LED+ PD* | | | | |

Coil versions, DC-coil, RM2, RM3

| | | | | | |
|------------------------|-----------|-------------|------------|----------------|------------|
| 006 L06 0A6 LA6 | 6 | 4.5 | 0.6 | 32±10% | 1.1 |
| 012 L12 0B2 LB2 | 12 | 9.0 | 1.2 | 110±10% | 1.3 |
| 024 L24 0C4 LC4 | 24 | 18.0 | 2.4 | 475±10% | 1.2 |
| 048 L48 0E8 LE8 | 48 | 36.0 | 4.8 | 2000±10% | 1.2 |
| 060 L60 0G0 LG0 | 60 | 45.0 | 6.0 | 2850±10% | 1.3 |
| 110 M10 1B0 MB0 | 110 | 82.5 | 11.0 | 10000±12% | 1.2 |

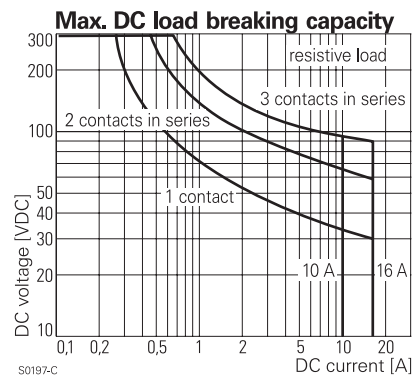

S0197-C

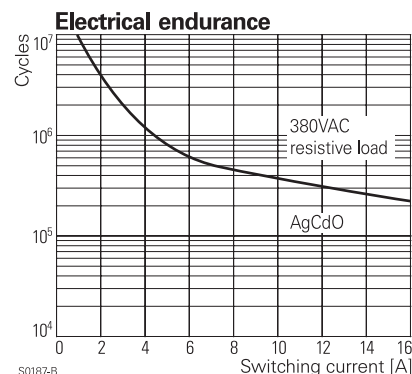

S0197-B

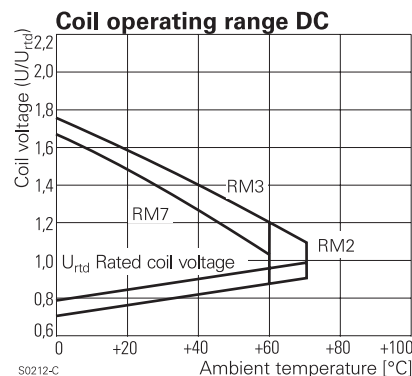

S0212-C

| | | | | | | | | | |
|------------------------------------|------------|------------|------------|------|---------------|-----------------|-----------------|-----------------|------------------|
| 221 | N21 | 2C1 | NC1 | 220 | 165.0 | 22.0 | 40000±15% | 1.2 | |
| Coil versions, DC-coil, RM7 | | | | | | | | | |
| Coil code | STD | LED | PD* | LED+ | Rated voltage | Operate voltage | Release voltage | Coil resistance | Rated coil power |
| | bipolar | | | | VDC | VDC | VDC | Ohm | W |
| 006 | L06 | 0A6 | LA6 | | 6 | 4.5 | 0.6 | 24±10% | 1.5 |
| 012 | L12 | 0B2 | LB2 | | 12 | 9.0 | 1.2 | 86±10% | 1.7 |
| 024 | L24 | 0C4 | LC4 | | 24 | 18.0 | 2.4 | 345±10% | 1.7 |
| 048 | L48 | 0E8 | LE8 | | 48 | 36.0 | 4.8 | 1340±10% | 1.7 |
| 060 | L60 | 0G0 | LG0 | | 60 | 45.0 | 6.0 | 2200±10% | 1.6 |
| 110 | M10 | 1B0 | MB0 | | 110 | 82.5 | 11.0 | 7300±10% | 1.7 |
| 221 | N21 | 2C1 | NC1 | | 220 | 165.0 | 22.0 | 30000±15% | 1.6 |

All figures are given for coil without preenergization, at ambient temperature +23°C

*) Protection diode PD; standard polarity: +A1 / -A2

Coil versions, AC-coil 50/60 Hz

| | | | | | | | |
|-----------|-----|-----|---------------|-----------------|-----------------|-----------------|------------------|
| Coil code | STD | LED | Rated voltage | Operate voltage | Release voltage | Coil resistance | Rated coil power |
| | | | VAC | 50/60Hz | 50/60Hz | Ohm | 50/60Hz |
| | | | VAC | VAC | VAC | Ohm | VA |

Coil versions, AC-coil, RM2, RM3

| | | | | | | |
|------------|------------|------------|--------------|-------------|-----------------|------------------|
| 506 | R06 | 6 | 4.8 | 2.4 | 5.3±10% | 2.29/1.98 |
| 512 | R12 | 12 | 9.6 | 4.8 | 24±10% | 2.19/1.86 |
| 524 | R24 | 24 | 19.2 | 9.6 | 86±10% | 2.26/1.95 |
| 548 | R48 | 48 | 38.4 | 19.2 | 345±10% | 2.28/1.97 |
| 560 | R60 | 60 | 48.0 | 24.0 | 544±10% | 2.27/1.96 |
| 615 | S15 | 115 | 92.0 | 46.0 | 2000±10% | 2.37/2.00 |
| 730 | T30 | 230 | 184.0 | 92.0 | 8300±12% | 2.32/1.96 |
| 900 | V00 | 400 | 320.0 | 160.0 | 27500±15% | 2.31/1.96 |

Coil versions, AC-coil, RM7

| | | | | | | |
|------------|------------|------------|--------------|-------------|-----------------|------------------|
| 506 | R06 | 6 | 4.8 | 2.4 | 4.7±10% | 2.86/2.36 |
| 512 | R12 | 12 | 9.6 | 4.8 | 19.5±10% | 2.71/2.27 |
| 524 | R24 | 24 | 19.2 | 9.6 | 80±10% | 2.62/2.00 |
| 548 | R48 | 48 | 38.4 | 19.2 | 320±10% | 2.60/2.17 |
| 560 | R60 | 60 | 48.0 | 24.0 | 500±10% | 2.62/2.20 |
| 615 | S15 | 115 | 92.0 | 46.0 | 1850±10% | 2.65/2.22 |
| 730 | T30 | 230 | 184.0 | 92.0 | 7500±10% | 2.69/2.26 |
| 900 | V00 | 400 | 320.0 | 160.0 | 23500±15% | 2.61/2.20 |

All figures are given for coil without preenergization, at ambient temperature +23°C

Insulation

| | |
|-------------------------------------------|-----------------------|
| Dielectric strength coil-contact circuit | 2500 V _{rms} |
| open contact circuit | 1500 V _{rms} |
| adjacent contact circuits | 2500 V _{rms} |
| Clearance / creepage coil-contact circuit | ≥ 4.0/14.9 mm |
| adjacent contact circuits | ≥ 6.1/7.3 mm |
| Material group of insulation parts | ≥ IIIa |
| Insulation to IEC 60664-1 | |
| Type of insulation coil-contact circuit | basic |
| open contact circuit | functional |
| adjacent contact circuits | basic |
| Rated insulation voltage | 250 V |
| Pollution degree | 3 |
| Rated voltage system | 240/400 V |
| Overvoltage category | III |

Other data

| | | | |
|-------------------------------------------------|-----------------------------------------|-------------|-------------|
| RoHS - Directive 2002/95/EC | compliant as per product date code 0415 | | |
| Ambient temperature range DC coil | -45...+70°C | -45...+60°C | -45...+60°C |
| AC coil | -45...+55°C | -45...+55°C | -45...+50°C |
| Operate- / release time | 15/10 ms | | |
| Bounce time NO / NC contact | 3 ms | | |
| Vibration resistance (function) NO / NC contact | 5/2 g | 5/2 g | 12/4 g |
| Category of protection | RTI - dust protected | | |
| Resistance to soldering heat | 270°C / 10 s | | |
| Relay weight | 81 g | | |
| Packaging unit | 10/25 pcs | | |

Coil operating range AC

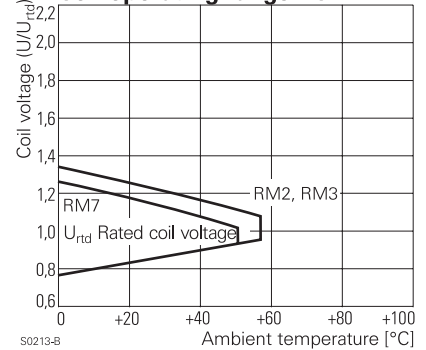

PCB layout / terminal assignment

Bottom view on pins

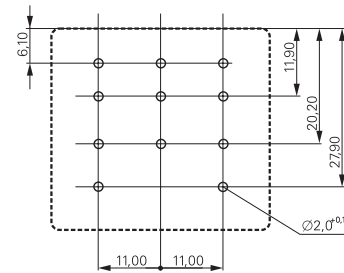

S0269-AA

3 CO contacts

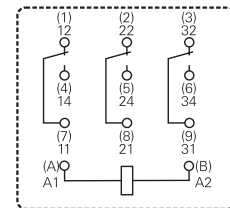

S0269-AB

2 CO contacts

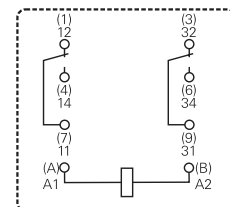

S0269-AD

Power Relay RM 2/3/7 (Continued)

Accessories

For details see datasheet

Accessories Power Relay RM

Dimensions

Plain cover, plug-in version

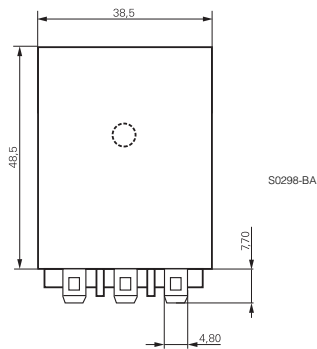

PCB version

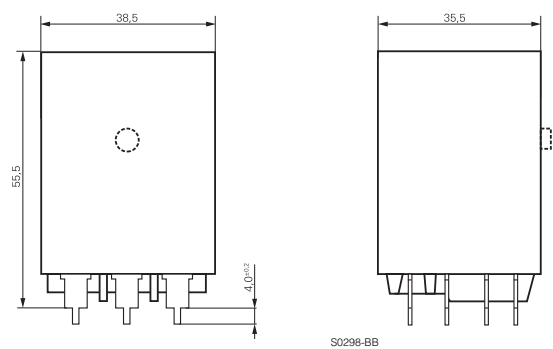

Cover with mounting brackets, 6.3 mm quick connect (4.8 mm available)

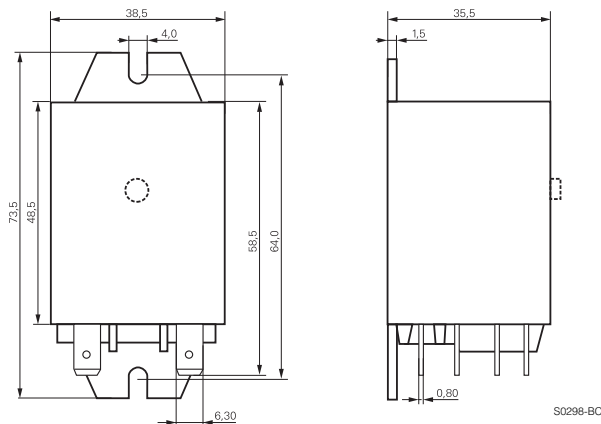

Cover with DIN-snap-on attachment (6.3 mm quick connect only) horizontal

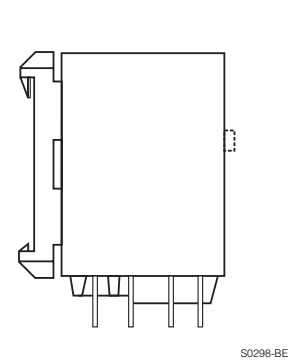
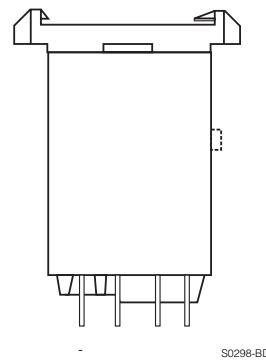

Product key

Type

Contact configuration

- 2** 2 CO contacts, 16 A
- 3** 3 CO contacts, 10 A
- 7** 3 CO contacts, 16 A

Version

- 0** AgCdO, without test button
- 3** AgCdO, with test button

Enclosure

- 2** plain cover, 4.8 mm quick connect terminals
- 3** cover with mounting brackets, 4.8 mm quick connect terminals
- 5** cover with mounting brackets, 6.3 mm quick connect terminals
- 7** PCB version
- 8** cover with DIN-snap-on attachment, horizontal, 6.3 mm quick connect terminals
- 9** cover with DIN-snap-on attachment, vertical, 6.3 mm quick connect terminals

Coil

Coil code: please refer to coil versions table, preferred types in bold print

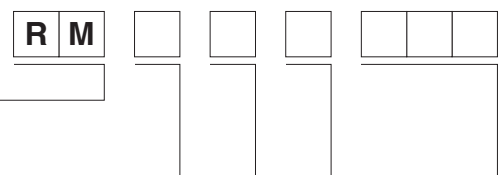

| Product key | Contacts | Version | Enclosure | Coil | Coil | Part number |
|-------------|-----------------------|------------------------|--------------------|---------|---------|-------------|
| RM202024 | 2 CO contacts 16 A | without test button | plain cover | DC-coil | 24 VDC | 8-1393149-2 |
| RM202524 | | | quick c. 4.8 mm | AC-coil | 24 VAC | 1-1393146-9 |
| RM202615 | | | | | 115 VAC | 2-1393146-0 |
| RM202730 | | | | | 230 VAC | 1-1393148-4 |
| RM203024 | | | mounting brackets | DC-coil | 24 VDC | 1-1393148-6 |
| RM203524 | | | quick c. 4.8 mm | AC-coil | 24 VAC | 2-1393146-5 |
| RM203615 | | | | | 115 VAC | 2-1393146-6 |
| RM203730 | | | | | 230 VAC | 2-1393146-8 |
| RM205024 | | | mounting brackets | DC-coil | 24 VDC | 2-1393146-9 |
| RM205524 | | | quick c. 6.3 mm | AC-coil | 24 VAC | 3-1393146-0 |
| RM205615 | | | | | 115 VAC | 3-1393146-1 |
| RM205730 | | | | | 230 VAC | 3-1393146-2 |
| RM207024 | | | PCB version | DC-coil | 24 VDC | 3-1393146-3 |
| RM207615 | | | | AC-coil | 115 VAC | 8-1393149-5 |
| RM207730 | | | | | 230 VAC | 3-1393146-4 |
| RM208024 | | | DIN-snap-on | DC-coil | 24 VDC | 3-1393146-5 |
| RM208730 | | | horizontal | AC-coil | 230 VAC | 8-1393149-6 |
| RM209730 | | | DIN vertical | | 230 VAC | 3-1393146-6 |
| RM232024 | with test button | | plain cover | DC-coil | 24 VDC | 3-1393146-8 |
| RM232524 | | | quick c. 4.8 mm | AC-coil | 24 VAC | 3-1393146-9 |
| RM232615 | | | | | 115 VAC | 4-1393146-0 |
| RM232730 | | | | | 230 VAC | 3-1393107-4 |
| RM233024 | | | mounting brackets | DC-coil | 24 VDC | 3-1393107-5 |
| RM233615 | | | quick c. 4.8 mm | AC-coil | 115 VAC | 4-1393146-2 |
| RM235024 | | | mounting brackets | DC-coil | 24 VDC | 8-1393149-8 |
| RM235730 | | | quick c. 6.3 mm | AC-coil | 230 VAC | 4-1393146-5 |
| RM239730 | | | DIN vertical | | 230 VAC | 4-1393148-7 |
| RM302024 | 3 CO contacts 10 A | without test button | plain cover | DC-coil | 24 VDC | 8-1393149-9 |
| RM302524 | | | quick c. 4.8 mm | AC-coil | 24 VAC | 5-1393146-3 |
| RM302615 | | | | | 115 VAC | 5-1393146-4 |
| RM302730 | | | | | 230 VAC | 5-1419150-3 |
| RM303024 | | | mounting brackets | DC-coil | 24 VDC | 6-1393148-4 |
| RM303615 | | | quick c. 4.8 mm | AC-coil | 115 VAC | 5-1393146-5 |
| RM303730 | | | | | 230 VAC | 5-1393146-7 |
| RM307024 | | | PCB version | DC-coil | 24 VDC | 7-1393148-2 |
| RM307730 | | | | AC-coil | 230 VAC | 5-1393146-9 |
| RM332024 | with test button | | plain cover | DC-coil | 24 VDC | 9-1393149-2 |
| RM332524 | | | quick c. 4.8 mm | AC-coil | 24 VAC | 9-1393149-3 |
| RM332730 | | | | | 230 VAC | 9-1393149-4 |
| RM333024 | | | mount. br. q.c.4.8 | DC-coil | 24 VDC | 9-1393149-6 |
| RM335730 | | | mount. br. q.c.6.3 | AC-coil | 230 VAC | 6-1393107-1 |
| RM338730 | | | DIN horizontal | | 230 VAC | 7-1393148-7 |
| RM339730 | | | DIN vertical | | 230 VAC | 6-1393107-2 |
| RM702024 | 3 CO contacts 16 A | without test button | plain cover | DC-coil | 24 VDC | 8-1393146-5 |
| RM702524 | | | quick c. 4.8 mm | AC-coil | 24 VAC | 0-1393844-9 |
| RM702615 | | | | | 115 VAC | 1-1393844-0 |
| RM702730 | | | | | 230 VAC | 1-1393844-1 |
| RM703024 | | | mounting brackets | DC-coil | 24 VDC | 1-1393844-2 |
| RM703524 | | | quick c. 4.8 mm | AC-coil | 24 VAC | 9-1393146-1 |
| RM703615 | | | | | 115 VAC | 9-1393146-2 |
| RM703730 | | | | | 230 VAC | 9-1393146-4 |
| RM705024 | | | mounting brackets | DC-coil | 24 VDC | 9-1393146-6 |
| RM705524 | | | quick c. 6.3 mm | AC-coil | 24 VAC | 9-1393146-7 |
| RM705615 | | | | | 115 VAC | 1-1393844-4 |
| RM705730 | | | | | 230 VAC | 1-1393844-5 |
| RM707024 | | | PCB version | DC-coil | 24 VDC | 9-1393146-8 |
| RM707524 | | | | AC-coil | 24 VAC | 0-1393147-1 |
| RM707730 | | | | | 230 VAC | 0-1393147-2 |
| RM708024 | | | DIN horizontal | DC-coil | 24 VDC | 0-1393147-4 |
| RM708730 | | | quick c. 6.3 mm | AC-coil | 230 VAC | 1-1419136-0 |
| RM709024 | | | DIN vertical | DC-coil | 24 VDC | 2-1393149-2 |
| RM709730 | | | | AC-coil | 230 VAC | 0-1393147-5 |
| RM732024 | with test button | | plain cover | DC-coil | 24 VDC | 1-1393844-7 |
| RM732524 | | | quick c. 4.8 mm | AC-coil | 24 VAC | 1-1393147-0 |
| RM732615 | | | | | 115 VAC | 1-1393147-1 |
| RM732730 | | | | | 230 VAC | 1-1393844-8 |
| RM733730 | | | mount.br. q.c. 4.8 | | 230 VAC | 1-1393147-5 |
| RM735024 | | | mounting brackets | DC-coil | 24 VDC | 3-1393149-6 |
| RM735524 | | | quick c. 6.3 mm | AC-coil | 24 VAC | 3-1393149-7 |
| RM735730 | | | | | 230 VAC | 4-1393149-1 |
| RM737730 | | | PCB version | | 230 VAC | 2-1393147-0 |
| RM738024 | | | DIN-snap-on | DC-coil | 24 VDC | 2-1393844-0 |
| RM738730 | | | horizontal | AC-coil | 230 VAC | 2-1393147-2 |
| RM739024 | | | DIN-snap-on | DC-coil | 24 VDC | 4-1393149-5 |
| RM739730 | | | vertical | AC-coil | 230 VAC | 2-1393844-2 |