

13 12 11 10 9 8 7 6 5 4 3 2 1

J
I
H
G
F
E
D
C
B
A

J
I
H
G
F
E
D
C
B
A

RECEPTACLE

PLUG

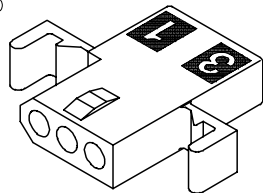
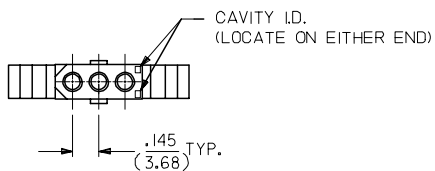
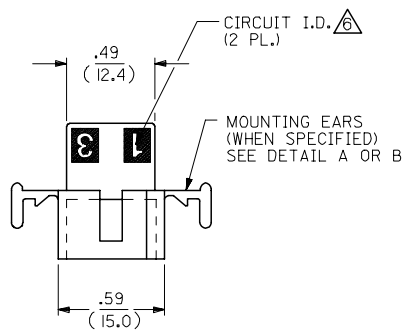
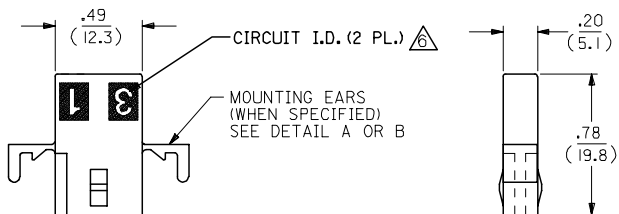
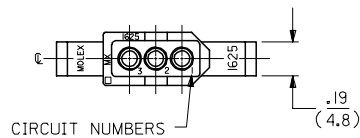
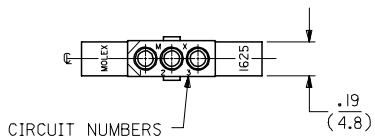

RECEPTACLE HOUSI NG
SHOWN WI TH STANDA RD EARS

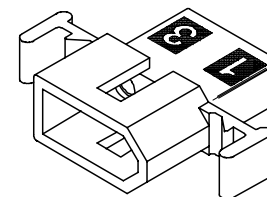
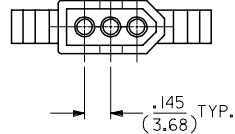

PLUG HOUSI NG
SHOWN WI TH STANDA RD EARS

UPDATE REV. LEVEL EC NO: UCP2007-1925 DRAWN/PRI/DOR 2007/02/08 CHKD: AEL/HAG 2007/02/12 APPR: FSM/TH 2007/02/12 M2	QUALI TY SYMBOLS ▽=0 ▽=0	GENERAL TOLERANCES (UNLESS SPECIFIED)		DIMENSION STYLE IN/MM	SCALE ---	DESIGN UNITS INCH	THIRD ANGLE PROJECTION	
		4 PLACES ± --- ± ---	DRAWN BY KBW	DATE 1/26/89	TITLE PLUG AND RECEPTACLE HOUSINGS, 3 CIRCUIT, .062 DIA.			
		3 PLACES ± --- ± .010	CHECKED BY RW	DATE 1/26/89	MOLEX INCORPORATED			
		2 PLACES ± 0.25 ± .014 1 PLACE ± 0.35 ± --- ANGULAR ±1/2°	APPROVED BY RAS	DATE 1/26/89	MATERIAL NO. SEE CHART	DOCUMENT NO. SD-1625-3*	SHEET NO. 1 OF 2	
DRAFT WHERE APPLICABLE MUST REMAIN WITHIN DIMENSIONS		SIZE C		THIS DRAWING CONTAINS INFORMATION THAT IS PROPRIETARY TO MOLEX INCORPORATED AND SHOULD NOT BE USED WITHOUT WRITTEN PERMISSION				

12 11 10 9 8 7 6 5 4 3 2 1

13 12 11 10 9 8 7 6 5 4 3 2 1

PLUG		OBSOLETE
PART NO.	ENG. NO.	
03-06-2031	I625-3P	
03-06-2032	I625-3P1	
03-06-2034	I625-3P4BK	
03-06-7032	I625-3P1BK	
03-06-2033	I625-3P4	

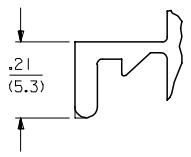

DETAIL A
.062/(1.57) STANDARD MOUNTING EAR
(SCALE 4:1)

LEGEND:

1625-3****

CIRCUIT SIZE

P = PLUG
R = RECEPTACLE

BLANK = WITH STANDARD EARS
1 = WITHOUT EARS
2 = WITHOUT EARS, WITHOUT DETENTS
3 = WITH STD. EARS, WITHOUT DETENTS
4 = WITH PREBENT EARS

COLOR:

BLANK = NATURAL COLOR
AM = AMBER BK = BLACK BU = BLUE
BN = BROWN GY = GRAY GN = GREEN
OR = ORANGE RD = RED YW = YELLOW

RECEPTACLE		OBSOLETE
PART NO.	ENG. NO.	
03-06-1033	I625-3R2	
03-06-1031	I625-3R	
03-06-1032	I625-3R1	
03-06-6031	I625-3RBK	
03-06-6032	I625-3R1BK	
03-06-1034	I625-3R3	
03-06-1038	I625-3R4	

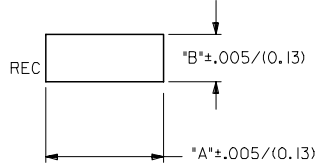
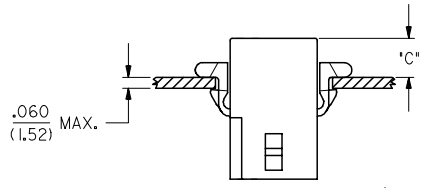

RECOMMENDED PANEL OPENING

HOUSING	DIM. "A"	DIM. "B"	"C" PREBENT EAR	"C" STANDARD EAR
PLUG	.754/(19.15)	.318/(8.08)	.19/(4.8)	.18/(4.6)
RECEPT.	.650/(16.51)	.265/(6.73)	.21/(5.3)	.20/(5.1)

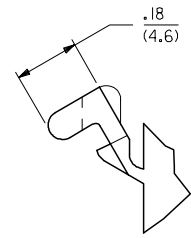

DETAIL B
.062/(1.57) PREBENT MOUNTING EAR
(SCALE 4:1)

- NOTES:-
- MATERIAL: NYLON TYPE 6/6, 94V-2.
 - FINISH: NONE.
 - PRODUCT SPECIFICATION: PS-02-06.
 - PACKAGING SPECS: BULK PACK PER PK-1625-001.
 - ACCEPTS MOLEX .062" SERIES TERMINALS.
 - CIRCUIT ID. NUMBERS ON HOUSING APPEAR ON PARTS FROM TOOLS BUILT AFTER 7/22/91.
 - PARTS CONFORM TO CLASS B REQUIREMENTS OF COSMETIC SPECIFICATION PS-45499-002.

ADD NOTE 7 EC NO: UCP2007-1925 DRAWN/PRD/DR CHKD: AEL/HAG APPR: FSM/TH M2	QUALITY SYMBOLS ▽=0 ▽=0	GENERAL TOLERANCES (UNLESS SPECIFIED)		DIMENSION STYLE IN/MM		SCALE ---	DESIGN UNITS INCH	THIRD ANGLE PROJECTION			
		4 PLACES ± --- ± ---	3 PLACES ± --- ± .010	2 PLACES ± 0.25 ± .014	1 PLACE ± 0.35 ± ---	ANGULAR ±1/2°	DRAWN BY KBW	DATE 01/26/89	TITLE PLUG AND RECEPTACLE HOUSINGS, 3 CIRCUIT, .062 DIA.		
		DRAFT WHERE APPLICABLE MUST REMAIN WITHIN DIMENSIONS		SEE CHART		MATERIAL NO. RAS		DATE 01/26/89		MOLEX INCORPORATED DOCUMENT NO. SD-1625-3*	
						SIZE C		SHEET NO. 2 OF 2		THIS DRAWING CONTAINS INFORMATION THAT IS PROPRIETARY TO MOLEX INCORPORATED AND SHOULD NOT BE USED WITHOUT WRITTEN PERMISSION	

12 11 10 9 8 7 6 5 4 3 2 1