

PVDZ172N

Microelectronic Power IC
HEXFET® Power MOSFET Photovoltaic Relay
Single Pole, Normally Open
0-60V DC, 1.5A

General Description

The PVDZ172N Photovoltaic Relay is a single-pole, normally open solid state relay that can replace electromechanical relays used for general purpose switching of DC loads. It utilizes International Rectifier's HEXFET power MOSFET as the output switch, driven by an integrated circuit photovoltaic generator of novel construction. The output switch is controlled by radiation from a GaAlAs light emitting diode (LED) which is optically isolated from the photovoltaic generator.

These units overcome the limitations of both electromechanical and reed relays by offering the solid-state advantages of high sensitivity, miniaturization, no contact bounce, long operational life, insensitivity to external magnetic fields, shock and vibration, and high reliability inherent with solid state technology. They are ideally suited for switching high currents or low level signals without distortion or injection of electrical noise.

These relays are packaged in 8-pin, molded DIP packages and available with thru-hole and surface-mount (gull-wing) leads, in plastic shipping tubes.

Applications

- Portable Electronics
- Programmable Logic Controllers
- Computers and Peripheral Devices
- Audio Equipment
- Power Supplies and Power Distribution
- Instrumentation

Features

- 250mΩ On-Resistance
- Bounce-Free Operation
- 1.5 Amp capacity
- 4,000 V_{RMS} I/O Isolation
- Solid-State Reliability
- UL recognized
- ESD Tolerance:
 - 4000V Human Body Model
 - 500V Machine Model

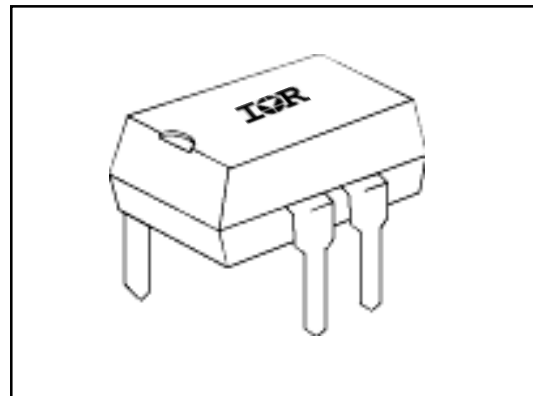

Part Identification

PVDZ172N	thru-hole
PVDZ172NS	surface-mount (gull-wing)

(HEXFET is the registered trademark for International Rectifier Power MOSFETs)

Electrical Specifications ($-40^{\circ}\text{C} \leq T_A \leq +85^{\circ}\text{C}$ unless otherwise specified)

INPUT CHARACTERISTICS	Limits	Units
Minimum Control Current (see figures 1 and 2)	10	mA
Maximum Control Current for Off-State Resistance @ $T_A=+25^{\circ}\text{C}$	0.4	mA
Control Current Range (Caution: Current limit input LED, see figure 6)	5.0 to 25	mA
Maximum Reverse Voltage	7.0	V

OUTPUT CHARACTERISTICS		Units
Operating Voltage Range	0 to 60	V(DC)
Maximum Load Current 40°C (see figures 1 and 2)	1.5	A(DC)
Maximum Pulsed Load Current @ $T_A=+25^{\circ}\text{C}$ (100 ms @ 10% duty cycle)	4.0	A(DC)
Maximum Turn-On Time @ $T_A=+25^{\circ}\text{C}$ (see figure 7) For 500mA, 50V _{DC} Load, 10mA Control	2.0	ms
Maximum Turn-Off Time @ $T_A=+25^{\circ}\text{C}$ (see figure 7) For 500mA, 50V _{DC} Load, 10mA Control	0.5	ms
Maximum On State Resistance @ $T_A=+25^{\circ}\text{C}$ (pulsed) (see figure 4) 1.0A load, 10mA Control	250	m Ω
Minimum Off State Resistance @ $T_A=+25^{\circ}\text{C}$ @ 48 V _{DC} (see figure 5)	10 ⁸	Ohms
Minimum Off-State dv/dt	1000	V/ μ s
Output Capacitance (see figure 9)	150	pF @ 50 VDC

GENERAL CHARACTERISTICS	Limits	Units
Dielectric Strength, Input-Output	4000	V _(RMS)
Insulation Resistance, Input-Output , 90 V _{DC}	10 ¹² @ $T_A=+25^{\circ}\text{C}$ - 50% RH	Ω
Capacitance, Input-Output	1.0	pF
Lead Temperature (1.6mm below seating plane) for 10 seconds	+260	$^{\circ}\text{C}$
Ambient Temperature Range:		
Operating	-40 to +85	$^{\circ}\text{C}$
Storage	-40 to +100	$^{\circ}\text{C}$

International Rectifier does not recommend the use of this product in aerospace, avionics, military or life support applications. Users of this International Rectifier product in such applications assume all risks of such use and indemnify International Rectifier against all damages resulting from such use.

Wiring Diagrams

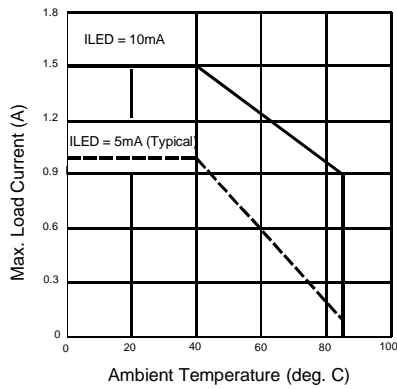
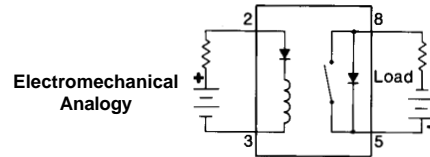
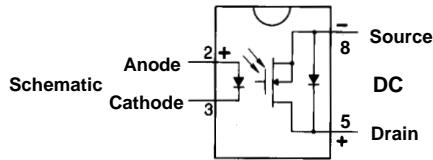

Figure 1. Current Derating Curves

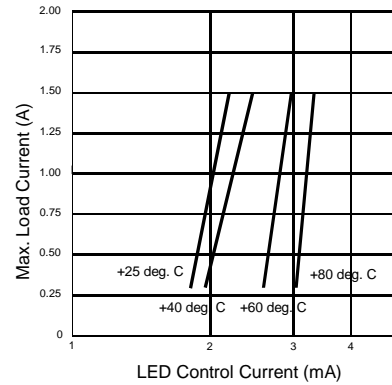

Figure 2. Typical Control Current Requirements

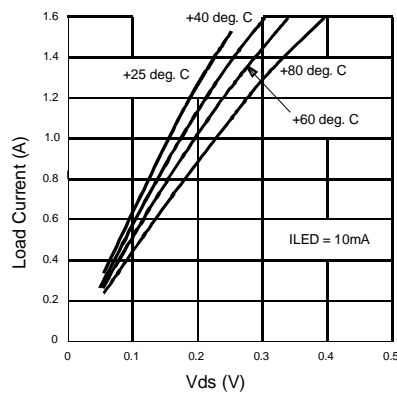

Figure 3. Typical On-Characteristics

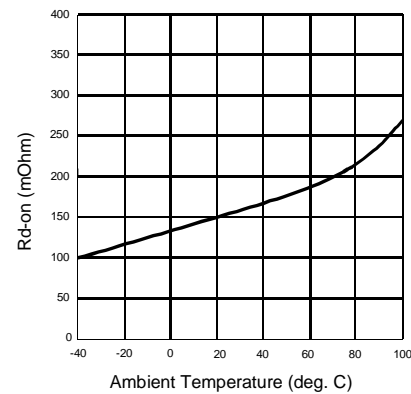

Figure 4. Typical On-Resistance

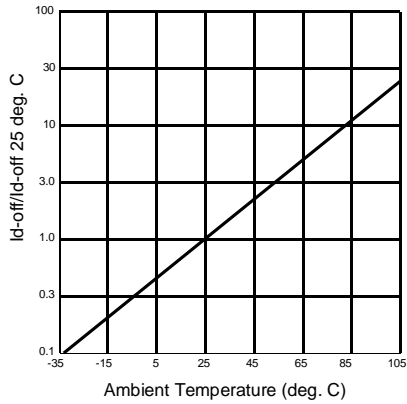

Figure 5. Typical Normalized Off-State Leakage

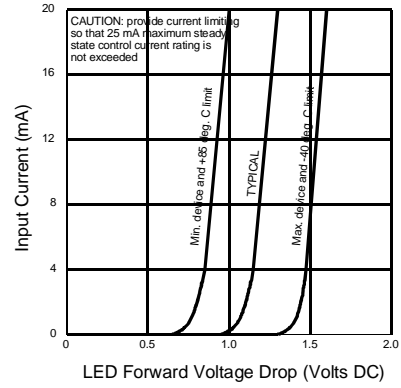

Figure 6. Input Characteristics (Current Controlled)

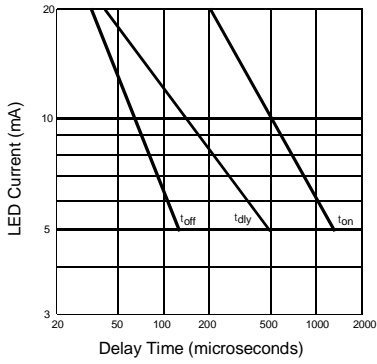

Figure 7. Typical Delay Times

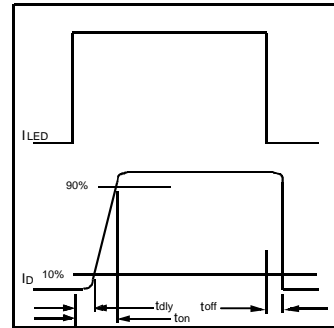

Figure 8. Delay Time Definitions

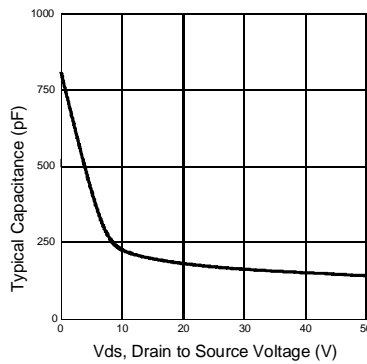
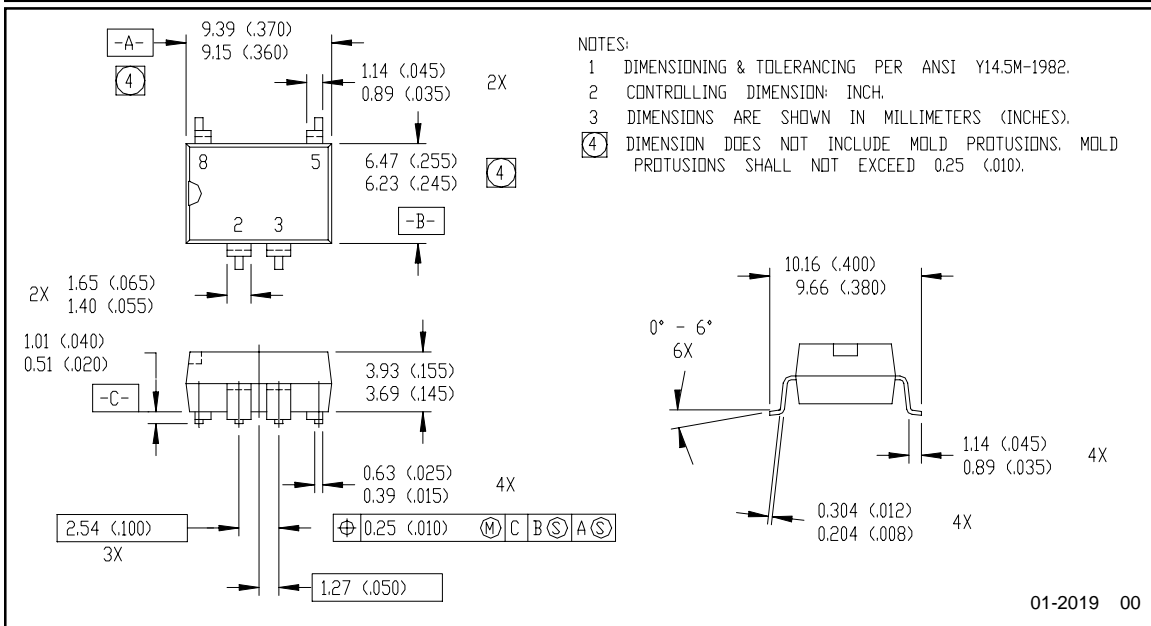
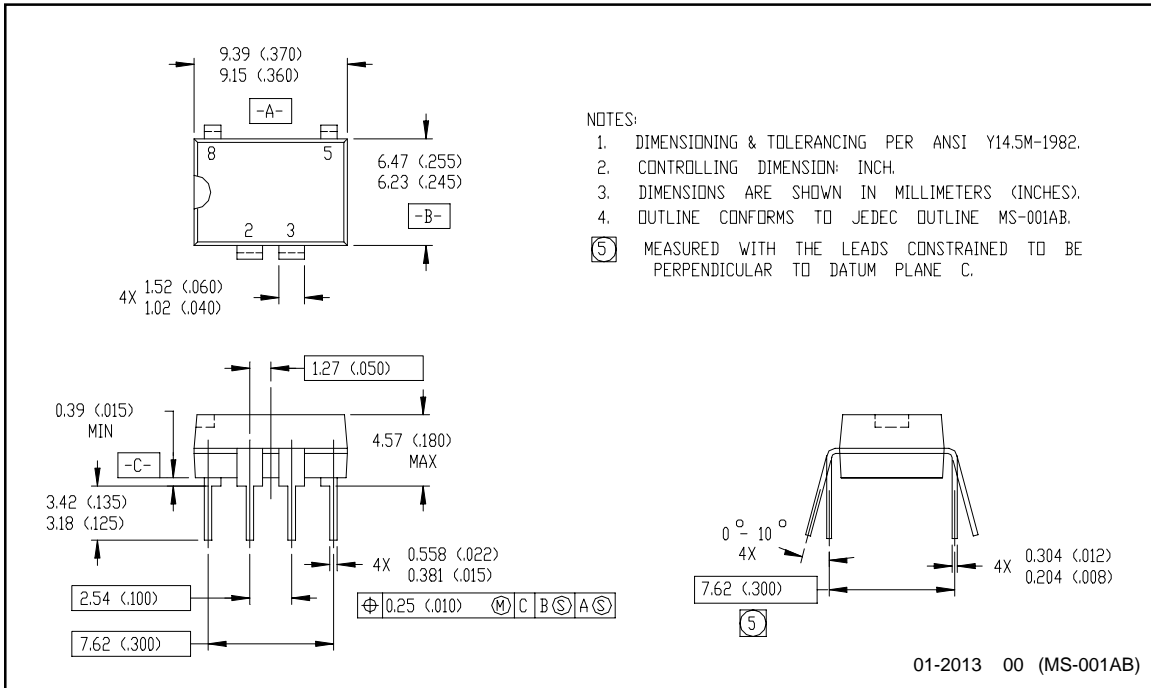

Figure 9. Typical Output Capacitance

Case Outlines



IR WORLD HEADQUARTERS: 233 Kansas St., El Segundo, California 90245 Tel: (310) 252-7105
Data and specifications subject to change without notice. 10/17/2003