

NF Contactor Relays

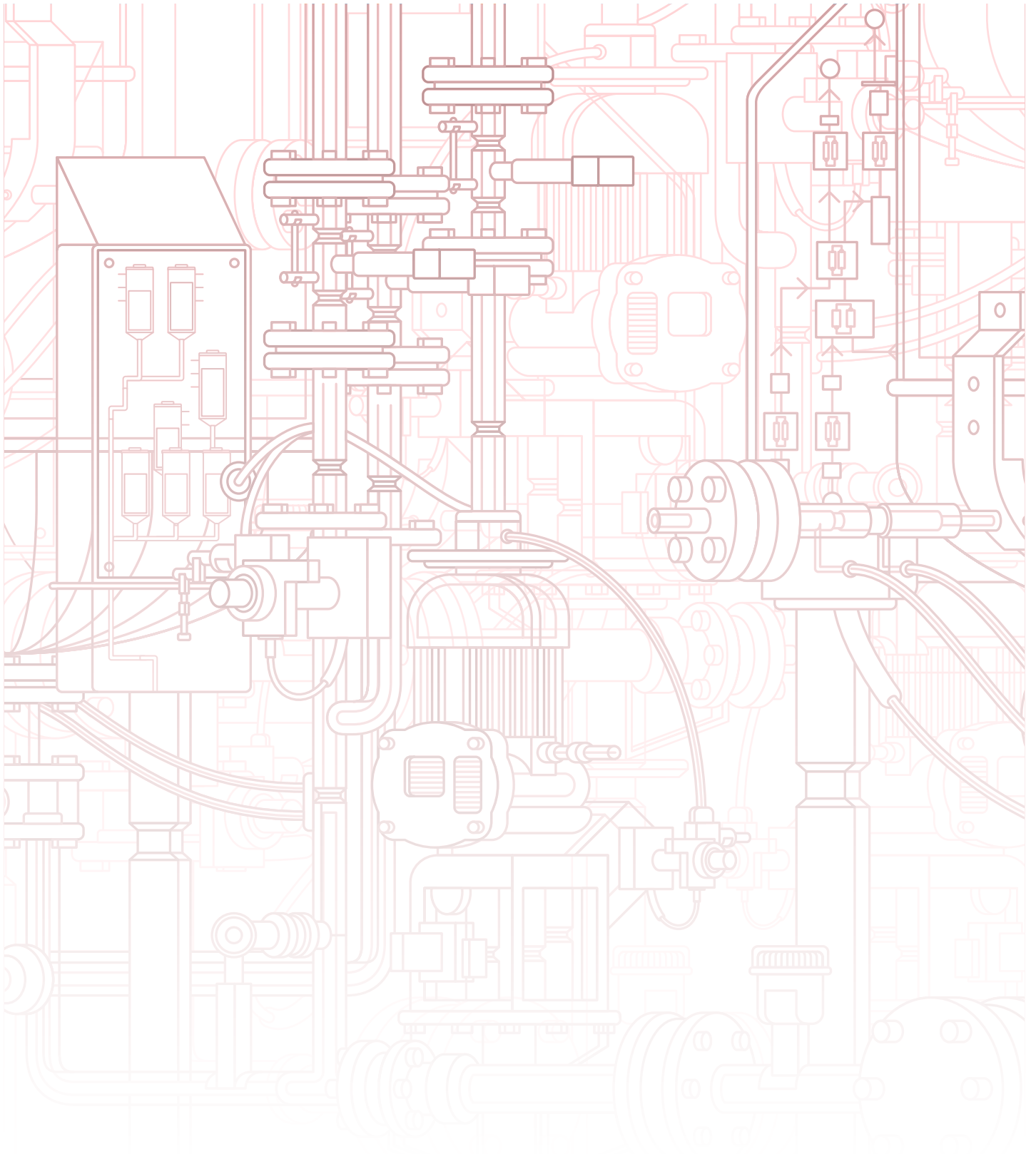

Overview	3
Ordering Details	
– NF Contactor Relays.....	4
– NF.Z Additional Coils.....	5
Technical Data	6
Main Accessory Fitting Details	9
Accessory Ordering Details and Technical Data	10
Terminal Marking and Positioning	13
Dimensions	15



Contactor Relays



⚡ AC / DC control voltage

NF22E	NF31E	NF40E	NF44E	NF53E	NF62E	NF71E	NF80E
2 N.O. + 2 N.C.	3 N.O. + 1 N.C.	4 N.O.	4 N.O. + 4 N.C.	5 N.O. + 3 N.C.	6 N.O. + 2 N.C.	7 N.O. + 1 N.C.	8 N.O.

Control Circuit Switching

Rated operational current	240 V	400 V	690 V	24 V	400 V
AC-15	4 A	3 A	2 A	6 A / 144 W	0.15 A / 60 W
IEC					A600, Q600
DC-13					
UL/CSA Pilot Duty					

Main Accessories

Auxiliary contact blocks	1-pole CA4-10 or CA4-01, CC4-10 or CC4-01	4-pole CA4	2-pole CAL4
Front mounting			—
Side mounting			—

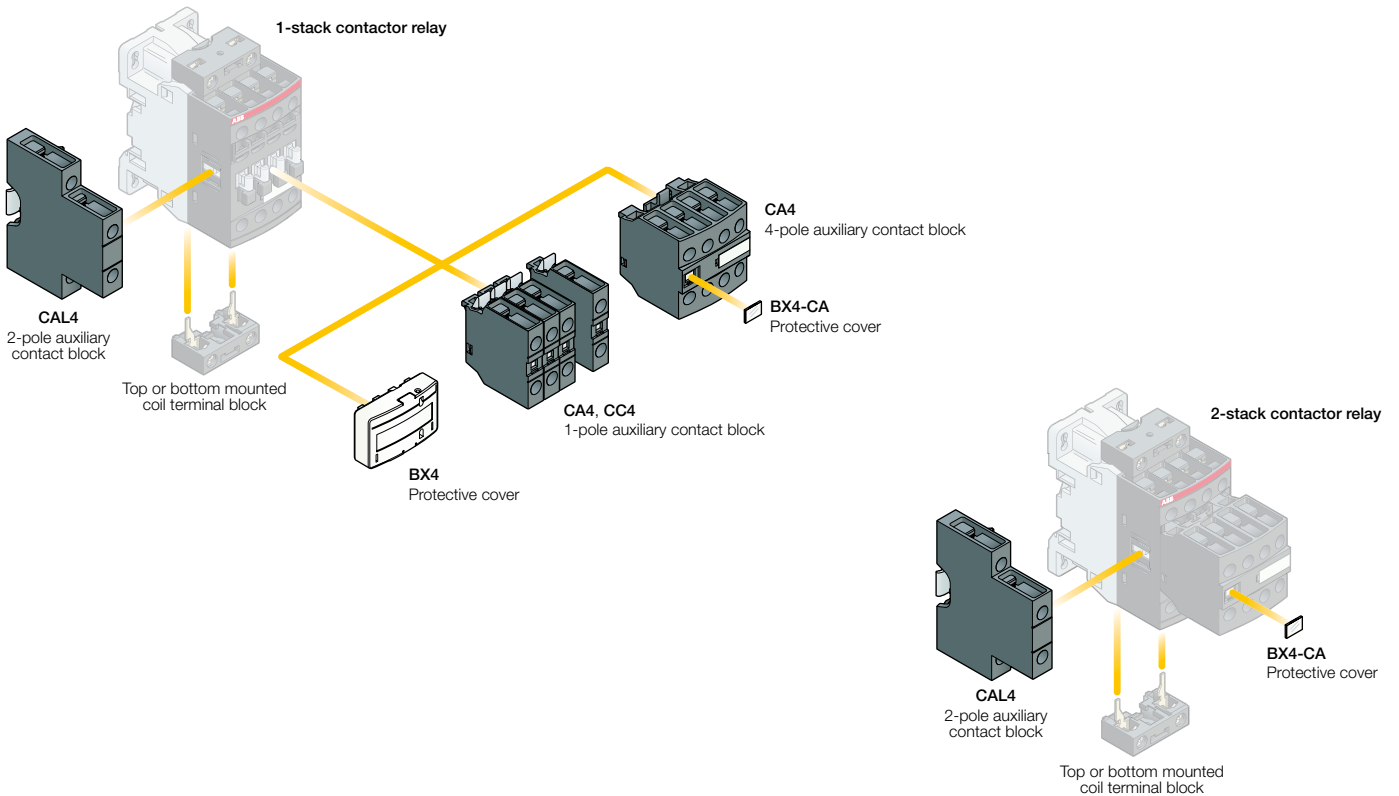

1S5C 101 131 S0201

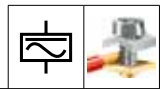

NF22E



NF44E

Application

NF contactor relays are used for switching auxiliary and control circuits.

Description

- NF contactor relays include an electronic coil interface accepting a wide control voltage U_c min. ... U_c max. Only four coils cover control voltages between 24...500 V 50/60 Hz or 20...500 V DC
- NF contactor relays can manage large control voltage variations. One coil (i.e. 100...250 V 50/60 Hz - DC) can be used for different control voltages used worldwide without any coil change
- NFZ contactor relays equipped with a Z coil type allow direct control by 24 V DC 500 mA PLC-output and obtain a reduced holding coil consumption.
- NFZ contactor relays withstand short dips and voltage interruptions (SEMI F47-0706 compliance)
- NF contactor relays have built-in surge protection and do not require additional surge suppressors
- The contactor relays have mechanically-linked auxiliary contacts compliant with Annex L of IEC 60947-5-1 and include the "Mechanically Linked" symbol on their side
- 8-pole contactor relays are mounted with a non-removable auxiliary contact block (2nd stack).

Ordering Details

Number of contacts		Control voltage U_c min. ... U_c max.	Type	Order code	Weight Pack ^(ing) 1 piece kg	
1 st stack	2 nd stack					
		V 50/60 Hz : V DC				
		24...60	20...60	NFZ22E-21	1SBH 136 001 R2122	0.310
		48...130	48...130	NF22E-12	1SBH 137 001 R1222	0.270
		100...250	100...250	NF22E-13	1SBH 137 001 R1322	0.270
	250...500	250...500	NF22E-14	1SBH 137 001 R1422	0.310	
		24...60	20...60	NFZ31E-21	1SBH 136 001 R2131	0.310
		48...130	48...130	NF31E-12	1SBH 137 001 R1231	0.270
		100...250	100...250	NF31E-13	1SBH 137 001 R1331	0.270
		250...500	250...500	NF31E-14	1SBH 137 001 R1431	0.310
		24...60	20...60	NFZ40E-21	1SBH 136 001 R2140	0.310
		48...130	48...130	NF40E-12	1SBH 137 001 R1240	0.270
		100...250	100...250	NF40E-13	1SBH 137 001 R1340	0.270
		250...500	250...500	NF40E-14	1SBH 137 001 R1440	0.310
		24...60	20...60	NFZ44E-21	1SBH 136 001 R2144	0.360
		48...130	48...130	NF44E-12	1SBH 137 001 R1244	0.320
		100...250	100...250	NF44E-13	1SBH 137 001 R1344	0.320
		250...500	250...500	NF44E-14	1SBH 137 001 R1444	0.360
		24...60	20...60	NFZ53E-21	1SBH 136 001 R2153	0.360
		48...130	48...130	NF53E-12	1SBH 137 001 R1253	0.320
		100...250	100...250	NF53E-13	1SBH 137 001 R1353	0.320
		250...500	250...500	NF53E-14	1SBH 137 001 R1453	0.360
		24...60	20...60	NFZ62E-21	1SBH 136 001 R2162	0.360
		48...130	48...130	NF62E-12	1SBH 137 001 R1262	0.320
		100...250	100...250	NF62E-13	1SBH 137 001 R1362	0.320
		250...500	250...500	NF62E-14	1SBH 137 001 R1462	0.360
		24...60	20...60	NFZ71E-21	1SBH 136 001 R2171	0.360
		48...130	48...130	NF71E-12	1SBH 137 001 R1271	0.320
		100...250	100...250	NF71E-13	1SBH 137 001 R1371	0.320
		250...500	250...500	NF71E-14	1SBH 137 001 R1471	0.360
		24...60	20...60	NFZ80E-21	1SBH 136 001 R2180	0.360
		48...130	48...130	NF80E-12	1SBH 137 001 R1280	0.320
		100...250	100...250	NF80E-13	1SBH 137 001 R1380	0.320
		250...500	250...500	NF80E-14	1SBH 137 001 R1480	0.360

NF Contactor Relays - NFZ Additional Coils

AC / DC Operated - with Screw Terminals



NFZ22E



NFZ44E

Application

NFZ contactor relays are used for switching auxiliary and control circuits.

Description

- NFZ contactor relays include an electronic coil interface accepting a wide control voltage U_c min. ... U_c max. and managing large control voltage variations.
- NFZ contactor relays cover control voltages between 24...250 V 50/60 Hz or 12...250 V DC
- NFZ contactor relays allow direct control by PLC-output ≥ 24 V DC 500 mA and obtain a reduced holding coil consumption.
- NFZ contactor relays withstand short dips and voltage interruptions (SEMI F47-0706 compliance)
- NFZ contactor relays have built-in surge protection and do not require additional surge suppressors
- The contactor relays have mechanically-linked auxiliary contacts compliant with Annex L of IEC 60947-5-1 and include the "Mechanically Linked" symbol on their side
- 8-pole contactor relays are mounted with a non-removable auxiliary contact block (2nd stack).

Ordering Details

Number of contacts 1 st stack 2 nd stack	Control voltage U_c min. ... U_c max.		Type	Order code	Weight Pack ^(mg) 1 piece kg
	V 50/60 Hz	V DC			
	-	12...20	NFZ22E-20	1SBH 136 001 R2022	0.310
	24...60	20...60	NFZ22E-21	1SBH 136 001 R2122	0.310
	48...130	48...130	NFZ22E-22	1SBH 136 001 R2222	0.310
	100...250	100...250	NFZ22E-23	1SBH 136 001 R2322	0.310
	-	12...20	NFZ31E-20	1SBH 136 001 R2031	0.310
	24...60	20...60	NFZ31E-21	1SBH 136 001 R2131	0.310
	48...130	48...130	NFZ31E-22	1SBH 136 001 R2231	0.310
	100...250	100...250	NFZ31E-23	1SBH 136 001 R2331	0.310
	-	12...20	NFZ40E-20	1SBH 136 001 R2040	0.310
	24...60	20...60	NFZ40E-21	1SBH 136 001 R2140	0.310
	48...130	48...130	NFZ40E-22	1SBH 136 001 R2240	0.310
	100...250	100...250	NFZ40E-23	1SBH 136 001 R2340	0.310
	-	12...20	NFZ44E-20	1SBH 136 001 R2044	0.360
	24...60	20...60	NFZ44E-21	1SBH 136 001 R2144	0.360
	48...130	48...130	NFZ44E-22	1SBH 136 001 R2244	0.360
	100...250	100...250	NFZ44E-23	1SBH 136 001 R2344	0.360
	-	12...20	NFZ53E-20	1SBH 136 001 R2053	0.360
	24...60	20...60	NFZ53E-21	1SBH 136 001 R2153	0.360
	48...130	48...130	NFZ53E-22	1SBH 136 001 R2253	0.360
	100...250	100...250	NFZ53E-23	1SBH 136 001 R2353	0.360
	-	12...20	NFZ62E-20	1SBH 136 001 R2062	0.360
	24...60	20...60	NFZ62E-21	1SBH 136 001 R2162	0.360
	48...130	48...130	NFZ62E-22	1SBH 136 001 R2262	0.360
	100...250	100...250	NFZ62E-23	1SBH 136 001 R2362	0.360
	-	12...20	NFZ71E-20	1SBH 136 001 R2071	0.360
	24...60	20...60	NFZ71E-21	1SBH 136 001 R2171	0.360
	48...130	48...130	NFZ71E-22	1SBH 136 001 R2271	0.360
	100...250	100...250	NFZ71E-23	1SBH 136 001 R2371	0.360
	-	12...20	NFZ80E-20	1SBH 136 001 R2080	0.360
	24...60	20...60	NFZ80E-21	1SBH 136 001 R2180	0.360
	48...130	48...130	NFZ80E-22	1SBH 136 001 R2280	0.360
	100...250	100...250	NFZ80E-23	1SBH 136 001 R2380	0.360

Note: Only NFZ contactor relays with DC control voltage 12...20 V DC need to respect the connection polarities indicated close to the coil terminals: A1+ for the positive pole and A2- for the negative pole



Contact Utilization Characteristics according to IEC

Contact relay types	NF
Standards	IEC 60947-1 / 60947-5-1 and EN 60947-1 / 60947-5-1
Rated operational voltage U_e max.	690 V
Conventional free-air thermal current I_{th} $\theta \leq 40$ °C	16 A
Rated frequency limits	25 ... 400 Hz
Rated operational current I_e / AC-15 acc. to IEC 60947-5-1	24-127 V 50/60 Hz 6 A 220-240 V 50/60 Hz 4 A 400-440 V 50/60 Hz 3 A 500 V 50/60 Hz 2 A 690 V 50/60 Hz 2 A
Making capacity AC-15	10 x I_e AC-15 acc. to IEC 60947-5-1
Breaking capacity AC-15	10 x I_e AC-15 acc. to IEC 60947-5-1
Rated operational current I_e / DC-13 acc. to IEC 60947-5-1	24 V DC 6 A / 144 W 48 V DC 2.8 A / 134 W 72 V DC 1 A / 72 W 110 V DC 0.55 A / 60 W 125 V DC 0.55 A / 69 W 220 V DC 0.27 A / 60 W 250 V DC 0.27 A / 68 W 400 V DC 0.15 A / 60 W 500 V DC 0.13 A / 65 W 600 V DC 0.1 A / 60 W
Short-circuit protection gG type fuse	10 A
Rated short-time withstand current I_{cw}	for 1.0 s 100 A for 0.1 s 140 A
Minimum switching capacity with failure rate acc. to IEC 60947-5-4	12 V / 3 mA 10^{-7}
Non-overlapping time between N.O. and N.C. contacts	≥ 2 ms
Heat dissipation per pole at 6 A	0.1 W
Max. electrical switching frequency	AC-15 1200 cycles/h DC-13 900 cycles/h

Main Pole - Utilization Characteristics according to UL / CSA

Contact relay types	NF
Standards	UL 508, CSA C22.2 N°14
Rated insulation voltage U_i	600 V
Max. rated voltage	600 V AC, 600 V DC
Pilot duty	A600, Q600
AC thermal rated current	10 A
AC maximum volt-ampere making	7200 VA
AC maximum volt-ampere breaking	720 VA
DC thermal rated current	2.5 A
DC maximum volt-ampere making-breaking	69 VA

Technical Data



General Technical Data

Contactor relay types	NF	
Rated insulation voltage U_i acc. to IEC 60947-5-1	690 V	
acc. to UL / CSA	600 V	
Rated impulse withstand voltage U_{imp}	6 kV	
Electromagnetic compatibility	Devices complying with IEC 60947-1 / EN 60947-1 - Environment A	
Ambient air temperature close to contactor		
Operation in free air	-40 ... +70 °C	
Storage	-60 ... +80 °C	
Climatic withstand	Category B according to IEC 60947-1 Annex Q	
Operating altitude	≤ 3000 m	
Mechanical durability		
Number of operating cycles	20 millions operating cycles	
Max. switching frequency	7200 cycles/h	
Shock withstand acc. IEC 60068-2-27 and EN 60068-2-27		
Mounting position 1	Shock direction	1/2 sinusoidal shock for 11 ms: no change in contact position
	A	30 g
	B1	25 g Closed position / 5 g Open position
	B2	15 g
	C1	25 g
	C2	25 g
Vibration withstand acc. to IEC 60068-2-6		
		5 ... 300 Hz
		4 g Closed position / 2 g Open position

Magnet System Characteristics









Contactor relay types	NF	
Coil operating limits acc. to IEC 60947-5-1	AC supply	at $\theta \leq 60^\circ\text{C}$ $0.85 \times U_c \text{ min} \dots 1.1 \times U_c \text{ max}$ at $\theta \leq 70^\circ\text{C}$ $0.85 \times U_c \text{ min} \dots U_c \text{ max}$
	DC supply	at $\theta \leq 60^\circ\text{C}$ $0.85 \times U_c \text{ min} \dots 1.1 \times U_c \text{ max}$ at $\theta \leq 70^\circ\text{C}$ (NF) $0.85 \times U_c \text{ min} \dots U_c \text{ max}$ - (NFZ) $0.85 \times U_c \text{ min} \dots 1.1 \times U_c \text{ max}$
AC control voltage Rated control circuit voltage U_c	24 ... 500 V AC	
50/60 Hz	Coil consumption	Average pull-in value (NF) 50 VA - (NFZ) 16 VA Average holding value (NF) 2.2 VA / 2 W - (NFZ) 1.7 VA / 1.5 W
DC control voltage Rated control circuit voltage U_c	12 ... 500 V DC	
	Coil consumption	Average pull-in value (NF) 50 W - (NFZ) 12 ... 16 W Average holding value (NF) 2 W - (NFZ) 1.7 W
PLC-Output control	(NFZ) $\geq 500 \text{ mA}$ 24 V DC	
Drop-out voltage in % of U_c min.	≤ 60 % U_c min	
Voltage sag immunity according to SEMI F47-0706	(NFZ) conditions of use on request	
Dips withstand (level 0% according to IEC 61000-4-11) -20 °C ≤ θ ≤ +60 °C	(NFZ) 22 ms average for $U_c = 24 \dots 250 \text{ V}$ 50/60Hz	
Operating time		
between coil energization and:	N.O. contact closing	40 ... 95 ms
	N.C. contact opening	38 ... 90 ms
between coil de-energization and:	N.O. contact opening	11 ... 95 ms
	N.C. contact closing	13 ... 98 ms

Mounting Characteristics

Contactor relay types	NF	
Mounting positions		
Mounting distances	Max. add-on N.C. auxiliary contacts: see accessory fitting details for a NF contactor relay	
Fixing	The contactor relays can be assembled side by side.	
on rail according to IEC 60715, EN 60715	35 x 7.5 mm or 35 x 15 mm	
by screws (not supplied)	2 x M4 screws placed diagonally	



Connecting Characteristics

Contactor relay types	NF
Main terminals	 <p>Screw terminals with cable clamp</p>
Connecting capacity (min. ... max.)	
Pole and coil terminals	
 Rigid	1 x 1 ... 2.5 mm ²
 Rigid	2 x 1 ... 2.5 mm ²
 Flexible with non insulated ferrule	1 x 0.75 ... 2.5 mm ²
 Flexible with non insulated ferrule	2 x 0.75 ... 2.5 mm ²
 Flexible with insulated ferrule	1 x 0.75 ... 2.5 mm ²
 Flexible with insulated ferrule	2 x 0.75 ... 1.5 mm ²
 Bars or lugs	L < 8 mm
Capacity according to UL/CSA	1 or 2 x AWG 18 ... 14
Stripping length	10 mm
Degree of protection	
acc. to IEC 60947-1 / EN 60947-1 and IEC 60529 / EN 60529	
All terminals	IP20
Screw terminals	(delivered in open position, screws of unused terminals must be tightened)
All terminals	M3.5
Screwdriver type	Flat Ø5.5 / Pozidriv 2
Tightening torque	
Pole terminals	1.2 Nm / 11 lb.in
Coil terminals	1.2 Nm / 11 lb.in



Accessory fitting details for a NF contactor relay

Many configurations of accessories are possible depending on whether these are front-mounted or side-mounted.

Contactor relay types	Main poles	Front-mounted accessories		Side-mounted accessories	
		Auxiliary contact blocks		Auxiliary contact blocks	
		1-pole CA4 1-pole CC4	4-pole CA4	Left side 2-pole CAL4-11	Right side
Max. add-on N.C. auxiliary contacts: 3 N.C. max. on positions 1, 2, 3, 4 and 2 N.C. max. on positions 1 ±30°, 5					
NF..	2 2 E	4 max.	or 1	+ 1	-
NF..	3 1 E	2 max.	-	+ 1	+ 1
Max. add-on N.C. auxiliary contacts: 4 N.C. max. on positions 1, 2, 3, 4 and 3 N.C. max. on positions 1 ±30°, 5					
NF..	4 0 E	4 max.	or 1	+ 1	-
		2 max.	-	+ 1	+ 1
NF..	4 4 E				
NF..	5 3 E				
NF..	6 2 E	-	-	1	-
NF..	7 1 E				
NF..	8 0 E				

Mounting positions

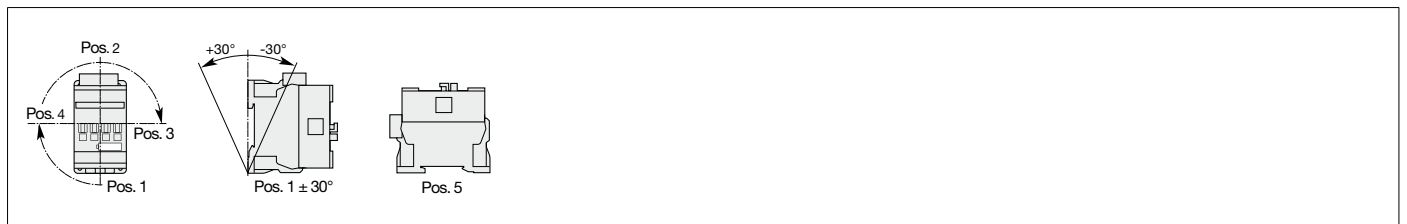

Contactor relays and main accessories (other accessories available)

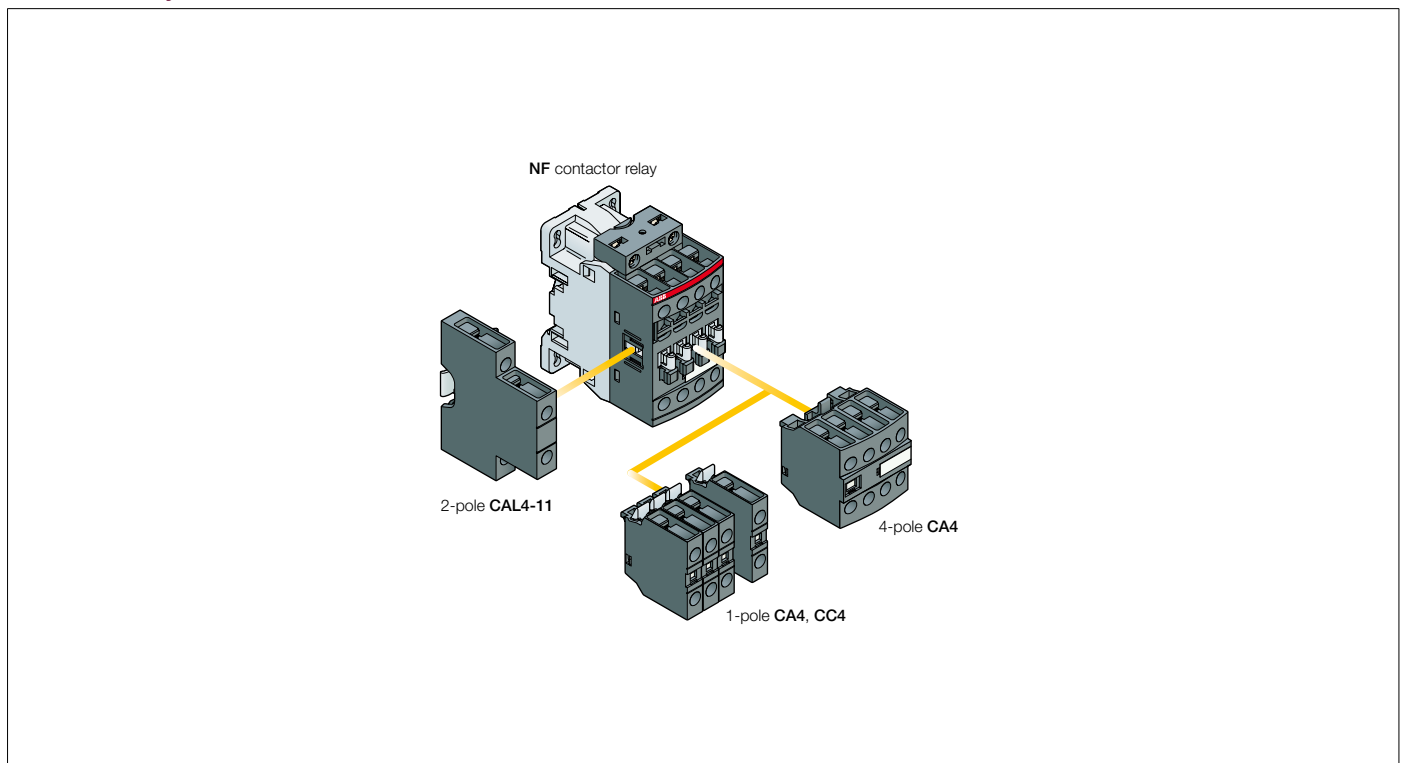

Auxiliary Contact Blocks

Accessories for NF Contactor Relays



CA4-10



CA4-22N



CAL4-11

Application

The auxiliary contact blocks are used for the operation of auxiliary circuits and control circuits.

Description

Types of auxiliary contact blocks for standard industrial environments:

- **CA4** 1 or 4-pole block, front-mounted, instantaneous with N.O., N.C. contacts.
- **CC4** 1-pole block, front-mounted, with N.O. leading contact or N.C. lagging contact.
- **CAL4** 2-pole block instantaneous N.O. + N.C. contacts clipped onto the right and/or left side of the contactors.

The auxiliary contact blocks are equipped with screw type connecting terminals delivered open, protected against accidental direct contact and bear the corresponding function marking.

Fitting Details - For each contactor relay type, refer to "Accessory Fitting Details" table.

Ordering Details

For contactor relays	Auxiliary contacts	Type	Order code	Pack ^(ing) pieces	Weight kg (1 pce)

Front-mounted instantaneous auxiliary contact blocks

4-pole NF	1 0 - -	CA4-10	1SBN 010 110 R1010	1	0.014
	1 0 - -	CA4-10-T	1SBN 010 110 T1010	10	0.014
	0 1 - -	CA4-01	1SBN 010 110 R1001	1	0.014
	0 1 - -	CA4-01-T	1SBN 010 110 T1001	10	0.014
	4 0 - -	CA4-40N	1SBN 010 140 R1240	1	0.055
	3 1 - -	CA4-31N	1SBN 010 140 R1231	1	0.055
	2 2 - -	CA4-22N	1SBN 010 140 R1222	1	0.055
	1 3 - -	CA4-13N	1SBN 010 140 R1213	1	0.055
NF..40E	0 4 - -	CA4-04N	1SBN 010 140 R1204	1	0.055

Front-mounted auxiliary contact blocks with N.O. leading contact and N.C. lagging contact

4-pole NF	- - 1 0	CC4-10	1SBN 010 111 R1010	1	0.014
	- - 0 1	CC4-01	1SBN 010 111 R1001	1	0.014

Side-mounted instantaneous auxiliary contact blocks

NF	1 1 - -	CAL4-11	1SBN 010 120 R1011	1	0.040
	1 1 - -	CAL4-11-T	1SBN 010 120 T1011	10	0.040

Auxiliary Contact Blocks

Accessories for NF Contactor Relays



Technical Data

Types	1-pole CA4, 1-pole CC4, 4-pole CA4, 2-pole CAL4	
Contact Utilization Characteristics according to IEC		
Standards	IEC 60947-5-1 and EN 60947-5-1	
Rated insulation voltage U_i acc. to IEC 60947-5-1	690 V	
Rated impulse withstand voltage U_{imp}	6 kV	
Rated operational voltage U_o max.	24 ... 690 V	
Conventional thermal current I_{th} - $\theta \leq 40$ °C	16 A	
Rated frequency limits	25 ... 400 Hz	
Rated operational current I_o / AC-15	24-127 V 50/60 Hz	6 A
acc. to IEC 60947-5-1	220-240 V 50/60 Hz	4 A
	400-440 V 50/60 Hz	3 A
	500 V 50/60 Hz	2 A
	690 V 50/60 Hz	2 A
Making capacity acc. to IEC 60947-5-1	10 x I_o AC-15 acc. to IEC 60947-5-1	
Breaking capacity acc. to IEC 60947-5-1	10 x I_o AC-15 acc. to IEC 60947-5-1	
Rated operational current I_o / DC-13	24 V DC	6 A / 144 W
acc. to IEC 60947-5-1	48 V DC	2.8 A / 134 W
	72 V DC	1 A / 72 W
	110 V DC	0.55 A / 60 W
	125 V DC	0.55 A / 69 W
	220 V DC	0.27 A / 60 W
	250 V DC	0.27 A / 68 W
	400 V DC	0.15 A / 60 W
	500 V DC	0.13 A / 65 W
	600 V DC	0.1 A / 60 W
Short-circuit protection gG type fuse	10 A	
Rated short-time withstand current I_{cw}	for 1.0 s	100 A
$\theta = 40$ °C	for 0.1 s	140 A
Minimum switching capacity	12 V / 3 mA	
with failure rate acc. to IEC 60947-5-4	10^{-7}	
Heat dissipation per pole at 6 A	0.1 W	
Mechanical durability	Number of operating cycles	10 millions operating cycles
	Max. switching frequency	3600 cycles/h
Max. electrical switching frequency	for AC-15	1200 cycles/h
	for DC-13	900 cycles/h

Contact Utilization Characteristics according to UL/CSA

Standards	UL 508, CSA C22.2 N°14
Rated insulation voltage U_i	600 V
Max. rated voltage	600 V AC, 600 V DC
Pilot duty	A600, Q600
AC thermal rated current	10 A
AC maximum volt-ampere making	7200 VA
AC maximum volt-ampere breaking	720 VA
DC thermal rated current	2.5 A
DC maximum volt-ampere making-breaking	69 VA

Connecting Characteristics

Screw terminals	(delivered in open position, screws of unused terminals must be tightened)	
All terminals	M3.5	
Connecting capacity (min. ... max.)		
Rigid solid	1 x	1 ... 2.5 mm ²
Rigid solid	2 x	1 ... 2.5 mm ²
Flexible with non insulated ferrule	1 x	0.75 ... 2.5 mm ²
Flexible with non insulated ferrule	2 x	0.75 ... 2.5 mm ²
Flexible with insulated ferrule	1 x	0.75 ... 2.5 mm ²
Flexible with insulated ferrule	2 x	0.75 ... 1.5 mm ²
Bars or lugs	L <	8 mm
Capacity acc. to UL/CSA	1 or 2 x	AWG 18 ... 14
Stripping length	10 mm	
Degree of protection	IP20	
acc. to IEC 60947-1 / EN 60947-1 and IEC 60529 / EN 60529		
Screwdriver type	Flat Ø5.5 / Pozidriv 2	
Tightening torque	1.2 Nm / 11 lb.in	



LDC4

Additional coil terminal block

Description

Additional coil terminal block for a bottom access to the coil terminals of contactors or contactor relays.

Ordering Details

For contactor relays	Type	Order code	Pack ^(ing) pieces	Weight kg (1 pce)
NF	LDC4	1SBN 070 156 T1000	10	0.010



BX4



BX4-CA

Protective covers

Description

Sealable and transparent protective covers BX4 and non-removable BX4-CA to protect the devices against accidental contact.

Ordering Details

For contactor relays	Type	Order code	Pack ^(ing) pieces	Weight kg (1 pce)
All 1-stack contactor relays	BX4	1SBN 110 108 T1000	10	0.006
For 4-pole CA4 auxiliary contact blocks	BX4-CA	1SBN 110 109 W1000	50	0.001



BA4

Function markers

Description

Box of 16 blank cards (16 markers by card) printable on HTP500 thermal transfer printer and AMS 500 marking table to identify your contactors, overload relays or manual motor starters.

Marker dimensions: 7 x 20 mm (.276" x .787")

Ordering Details

For contactor relays	Type	Order code	Pack ^(ing) pieces	Weight kg (1 pce)
Marker card	BA4	1SNA 235 156 R2700	16	0.011
AMS 500 support plate for 8 BA4	SPRC 1	1SNA 360 010 R1500	1	0.290
HTP500 support plate	HTP500-BA4	1SNA 235 712 R2400	1	0.220

NF Contactor Relays

Terminal Marking and Positioning



Standard devices without addition of auxiliary contacts

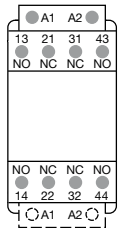

NF.22E

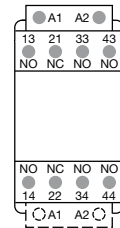

NF.31E

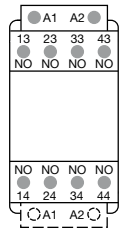

NF.40E

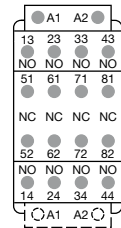

NF.44E

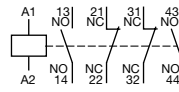

NF.22E

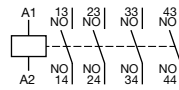

NF.40E

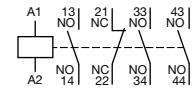

NF.31E

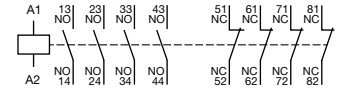

NF.44E

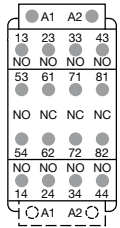

NF.53E

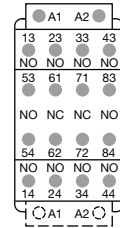

NF.62E

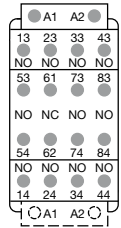

NF.71E

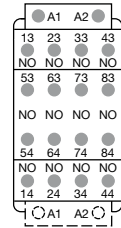

NF.80E

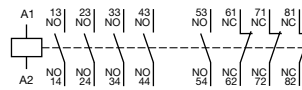

NF.53E

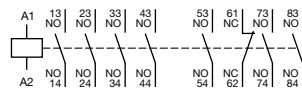

NF.71E

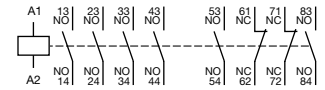

NF.62E

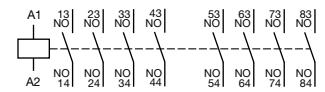

NF.80E

Other possible contact combinations with auxiliary contacts added by the user

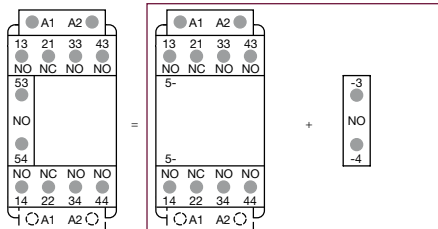

Combination 41 = NF.31E + CA4-10

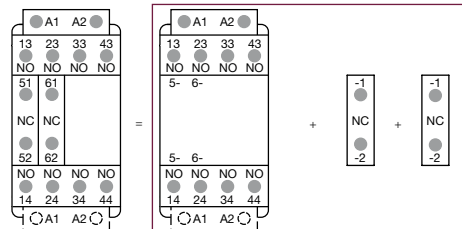

Combination 42 = NF.40E + CA4-01+CA4-01

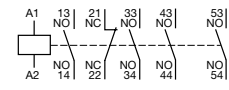

Combination 41 E

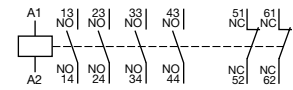

Combination 42 E

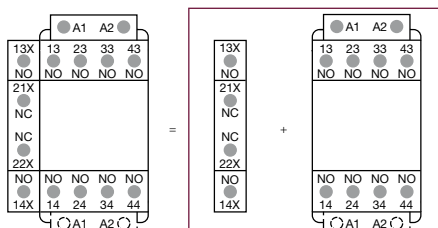

Combination 51 = CAL4-11 + NF.40E

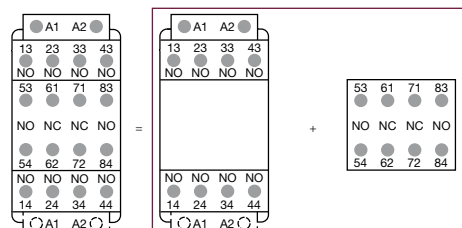

Combination 62 = NF.40E + CA4-22N

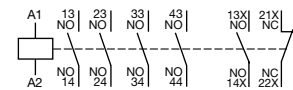

Combination 51 E

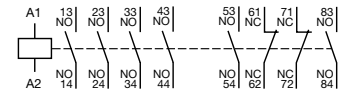

Combination 62 E

Note: Only NFZ contactor relays with DC control voltage 12...20 V DC need to respect the connection polarities indicated close to the coil terminals: A1+ for the positive pole and A2- for the negative pole.

NF Add-on Auxiliary Contacts

Terminal Marking and Positioning



1-pole auxiliary contacts

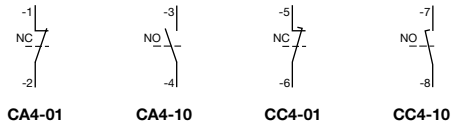

2-pole auxiliary contacts

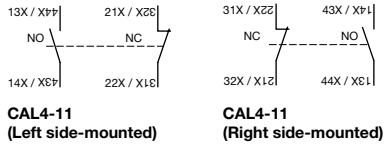

4-pole auxiliary contacts

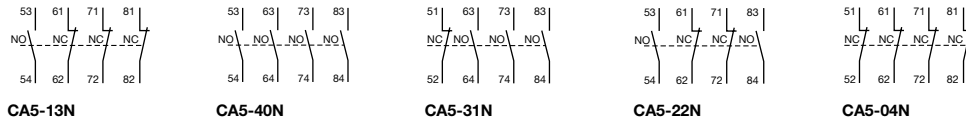

NF Contactor Relays

AC / DC Operated - with Screw Terminals



Dimensions mm, inches

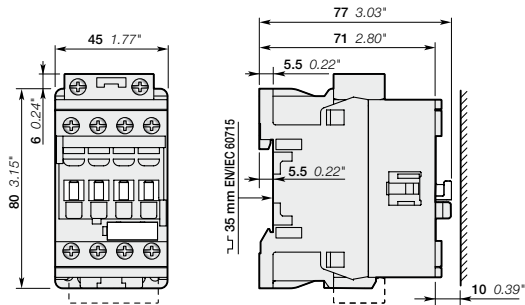

NF.22E, NF.31E, NF.40E

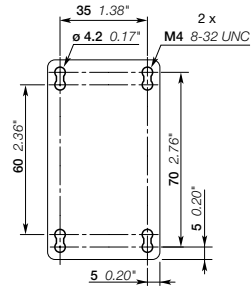

NF

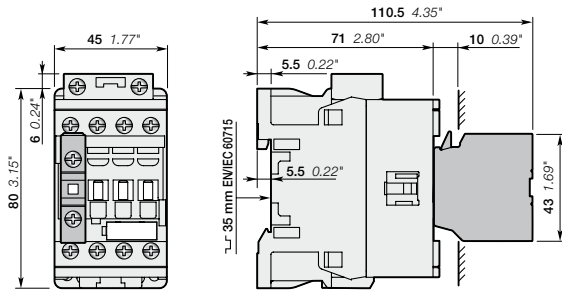

NF.22E, NF.31E, NF.40E
+ CA4, CC4 1-pole auxiliary contact block

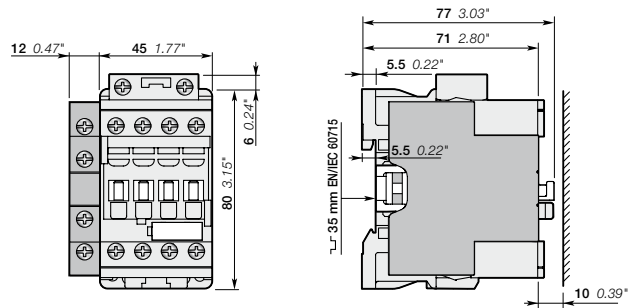

NF.22E, NF.31E, NF.40E
+ CAL4-11 2-pole auxiliary contact block

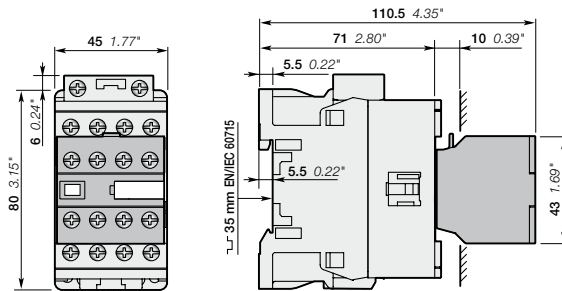

NF.22E, NF.31E, NF.40E
+ CA4 4-pole auxiliary contact block

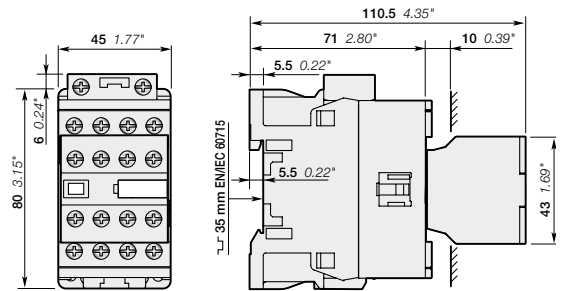

NF.44E, NF.53E, NF.62E, NF.71E, NF.80E

Note: contactor relay lateral distance to grounded component 2 mm 0.08" min.

Contact us

ABB France

Automation Products Division

10, rue Ampère Z.I. - B.P. 114
F-69685 Chassieu cedex / France

ABB STOTZ-KONTAKT GmbH

Eppelheimer Straße 82
D-69123 Heidelberg / Germany

ABB AB/ Cewe-Control

Motorgränd 20
S-721 61 Västerås / Sweden

You can find the address of your local sales organisation
on the ABB home page

<http://www.abb.com/contacts> -> Low Voltage products

Note

We reserve the right to make technical changes or modify the contents of this document without prior notice. With regard to purchase orders, the agreed particulars shall prevail. ABB does not accept any responsibility whatsoever for potential errors or possible lack of information in this document.

We reserve all rights in this document and in the subject matter and illustrations contained therein. Any reproduction, disclosure to third parties or utilization of its contents – in whole or in parts – is forbidden without prior written consent of ABB.

Copyright© 2009 ABB
All rights reserved