

Data Sheet

Description

Avago Technologies' MGA-631P8 is an economical, easy-to-use GaAs MMIC Low Noise Amplifier (LNA) with active bias. The LNA has low noise with excellent input return loss and high linearity achieved through the use of Avago Technologies' proprietary 0.5um GaAs Enhancement-mode pHEMT process. The LNA has an extra feature that allows a designer to adjust supply current and gain externally. Due to the high isolation between the input and output, gain can be adjusted independently through a resistor in series with a blocking capacitor from the output pin to FB1 pin, without affecting the noise figure. It is housed in a miniature 2.0 x 2.0 x 0.75mm³ 8-pin Thin Small Leadless Package (TSLP) package. The compact footprint and low profile coupled with low noise, high gain, excellent input return loss and high linearity make the MGA-631P8 an ideal choice as an LNA for cellular infrastructure for GSM, CDMA, GPS and ISM applications.

It is designed for optimum use between 400MHz to 1.5GHz. For optimum performance at higher frequency from 1.4GHz to 3GHz, the MGA-632P8 is recommended. Both MGA-631P8 and MGA-632P8 share the same package and pinout.

Pin Configuration and Package Marking

2.0 x 2.0 x 0.75 mm³ 8-lead TSLP



Top View

Note:
 Package marking provides orientation and identification
 "G1" is Device Code
 "X" is month code

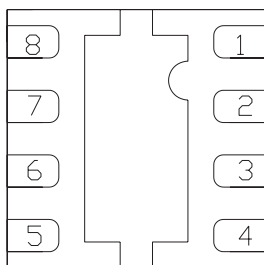

Bottom View

Note:
 Pin 1 : not used Pin 5 : FB1
 Pin 2 : RFin Pin 6 : not used
 Pin 3 : RF ground Pin 7 : RFout
 Pin 4 : Vbias Pin 8 : Gnd

Features

- Low noise figure
- Good input return loss
- High linearity performance
- High Isolation
- Externally adjustable supply current, 40-80mA
- Externally adjustable gain, 15-20dB
- GaAs E-pHEMT Technology^[1]
- Low cost small package size: 2.0x2.0x0.75 mm³
- Excellent uniformity in product specifications

Specifications

900MHz; 4V, 60mA (typ)

- 17.5 dB Gain
- 0.53 dB Noise Figure
- -19.4dB S11
- -34dB S12
- 33.1 dBm Output IP3
- 18.0 dBm Output Power at 1dB gain compression

Applications

- Low noise amplifier for cellular infrastructure for GSM, CDMA, GPS and ISM.
- Other ultra low noise applications.

Note:

[1] Enhancement mode technology employs positive Vgs, thereby eliminating the need of negative gate voltage associated with conventional depletion mode devices.



Attention: Observe precautions for handling electrostatic sensitive devices.
 ESD Machine Model = 50 V
 ESD Human Body Model = 200 V
 Refer to Avago Application Note A004R: Electrostatic Discharge, Damage and Control.

MGA-631P8 Absolute Maximum Rating^[1]

Symbol	Parameter	Units	Absolute Max.
V _d	Device Supply Voltage	V	5.5
V _{bias}	Control Voltage	V	3.5
P _{in,max}	CW RF Input Power (V _d = 4.0, V _{bias} = 2.2V)	dBm	13
P _{diss}	Total Power Dissipation ^[iii]	W	0.55
T _j	Junction Temperature	°C	150
T _{STG}	Storage Temperature	°C	-65 to 150

Thermal Resistance ^[iii] (V_d = 4.0V, V_{bias} = 2.2V), $\theta_{JC} = 47 \text{ }^\circ\text{C/W}$

Notes:

- Operation of this device in excess of any of these limits may cause permanent damage.
- Thermal resistance measured using Infra-Red Microscopy Technique.
- Board temperature T_B is 25 °C. Derate 21.2mW/°C for T_B > 124 °C.

Product Consistency Distribution Charts^[2]

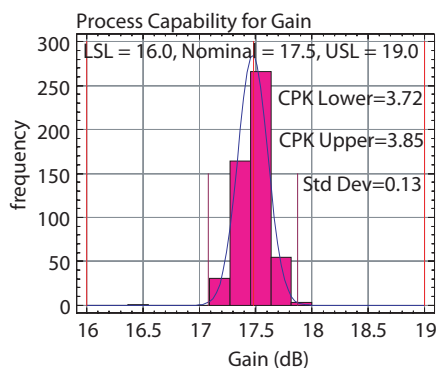

Figure 1. Gain distribution at 60mA

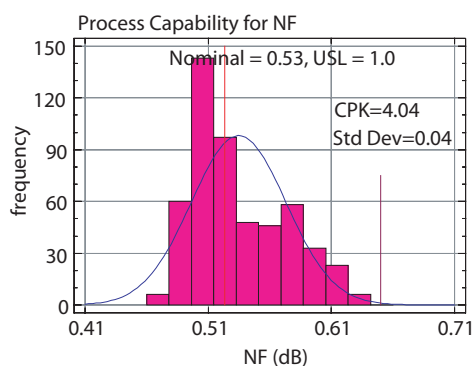

Figure 2. NF distribution at 60mA

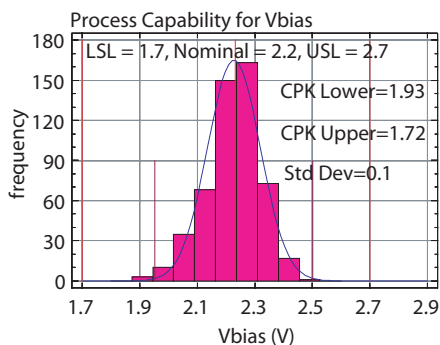

Figure 3. V_{bias} distribution at 60mA

[2] Distribution data sample size is 500 samples taken from 3 different wafer lots. Future wafer allocated to this product may have nominal values anywhere between the upper and lower limits. Circuit losses have been de-embedded from actual measurements.

Electrical Specifications^{[3][4]}

T_A = 25 °C, V_d =4V @ 60mA, R₁=91ohm unless otherwise specified.

Symbol	Parameter and Test Condition	Units	Min.	Typ.	Max.
Vbias	Operational Gate Voltage, I _{ds} =60mA		1.7	2.2	2.7
Gain	Freq=800 MHz	Associated Gain	dB	18.4	19.0
	Freq=850 MHz			17.9	
	Freq=900 MHz			16.0	
OIP3	Freq=800 MHz	Output Third Order Intercept Point (2-tone @ F _{RF} +/- 5MHz, Pin = -20dBm)	dBm	34.2	
	Freq=850 MHz			33.8	
	Freq=900 MHz			33.1	
NF _{50Ω}	Freq=800 MHz	Noise Figure in 50Ω system	dB	0.57	1.0
	Freq=850 MHz			0.51	
	Freq=900 MHz			0.53	
OP1dB	Freq=800 MHz	Output Power at 1dB Gain Compression	dBm	18.3	
	Freq=850 MHz			18.0	
	Freq=900 MHz			18.0	
IRL	Freq=800 MHz	Input Return Loss	dB	-20.9	
	Freq=850 MHz			-30.6	
	Freq=900 MHz			-19.4	
ORL	Freq=800 MHz	Output Return Loss	dB	-21.3	
	Freq=850 MHz			-22.1	
	Freq=900 MHz			-22.5	
S12	Freq=800 MHz	Reverse Isolation	dB	-34.0	
	Freq=850 MHz			-34.0	
	Freq=900 MHz			-34.0	

Notes:

[3] Measurements obtained using demo board described in Figure 28 and Table 1, List 1. Input and output board losses have been de-embedded.

[4] Guaranteed specifications are 100% tested in production test circuit.

MGA-631P8 Typical Performance^[5]

T_A = 25 °C, V_d = 4V, I_d = 60mA, R₁=91ohm unless stated otherwise.

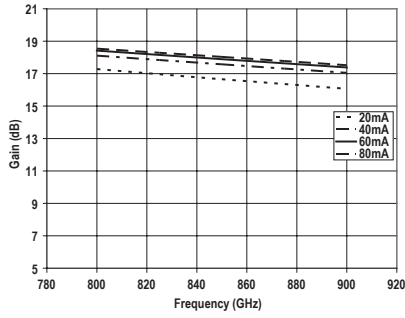

Figure 4. Gain Vs Frequency and Id

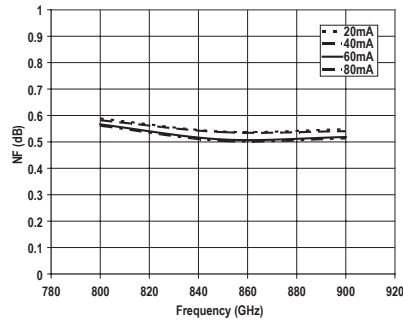

Figure 5. NF Vs Frequency and Id

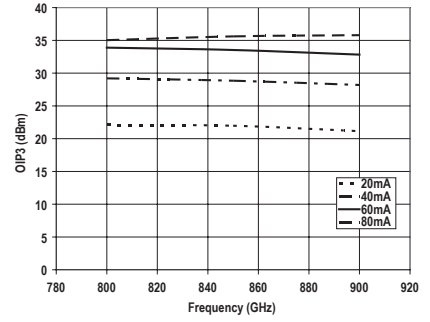

Figure 6. OIP3 Vs Frequency and Id

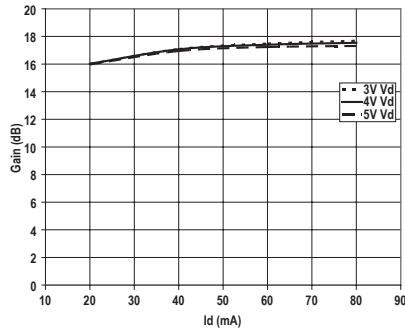

Figure 7. Gain Vs Id and Vd

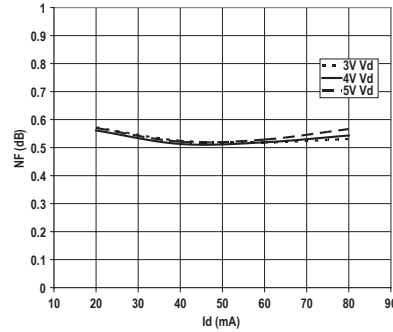

Figure 8. NF Vs Id and Vd

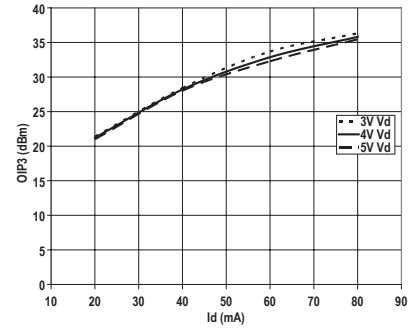

Figure 9. OIP3 Vs Id and Vd

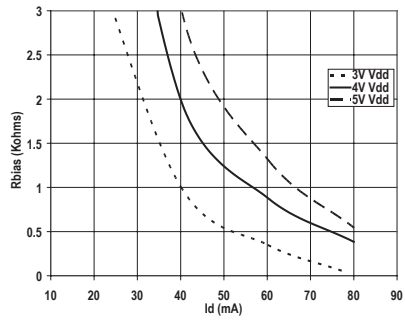

Figure 10. Rbias Vs Id and Vd

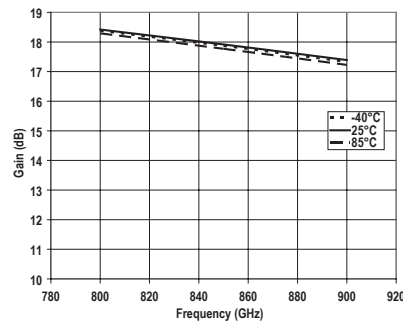

Figure 11. Gain Vs Frequency and Temperature

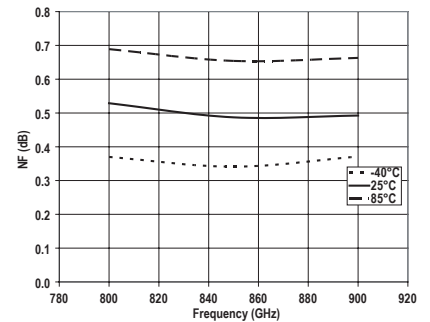

Figure 12. NF Vs Frequency and Temperature

Notes:

[5] Measurements obtained using demo board described in Figure 28 and Table 1, List 1.

MGA-631P8 Typical Performance^[5]

$T_A = 25^\circ\text{C}$, $V_d = 4\text{V}$, $I_d = 60\text{mA}$, $R_1 = 91\text{ohm}$ unless stated otherwise.

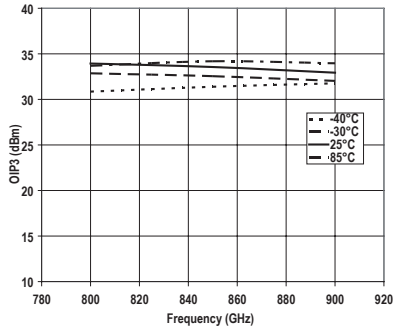

Figure 13. OIP3 vs Frequency and Temperature

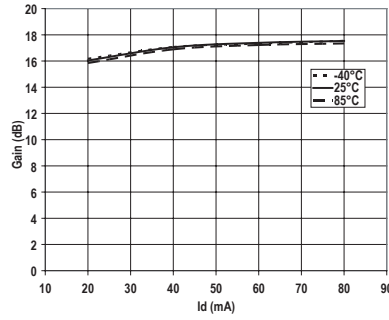

Figure 14. Gain vs Id and Temperature

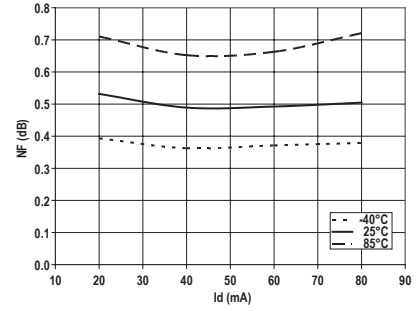

Figure 15. NF vs Id and Temperature

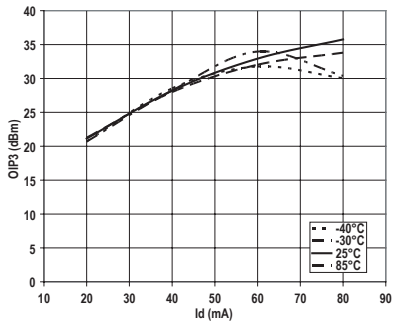

Figure 16. OIP3 vs Id and Temperature

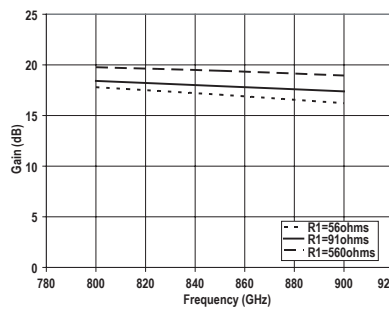

Figure 17. Gain Vs Frequency and R1

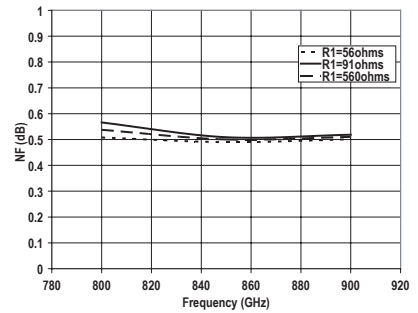

Figure 18. NF Vs Frequency and R1

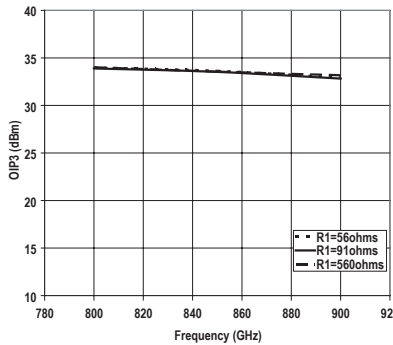

Figure 19. OIP3 Vs Frequency and R1

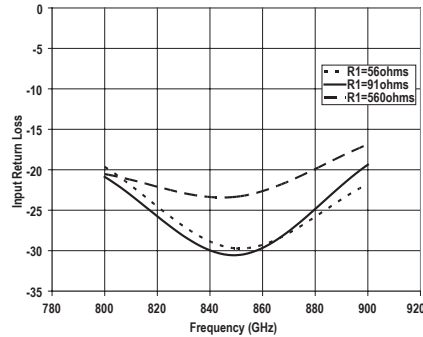

Figure 20. Input Return Loss Vs Frequency and R1

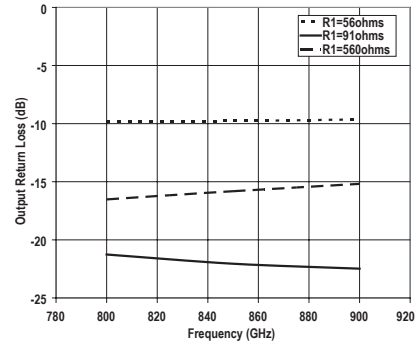

Figure 21. Output Return Loss Vs Frequency and R1

Notes:

[5] Measurements obtained using demo board described in Figure 28 and Table 1, List 1.

MGA-631P8 Typical Performance for 450 Mz Matching [6]

$T_A = +25\text{ }^\circ\text{C}$, $V_d = 4\text{V}$, $I_d = 60\text{mA}$

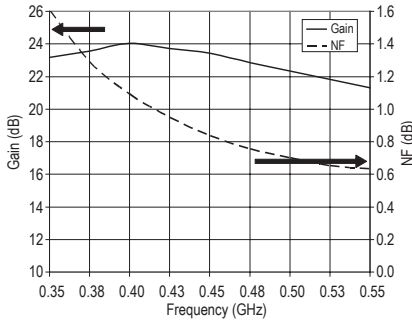

Figure 22. Gain and NF Vs Frequency

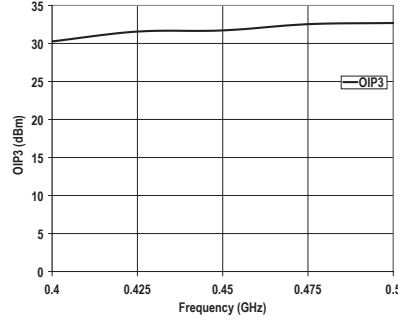

Figure 23. OIP3 vs Frequency

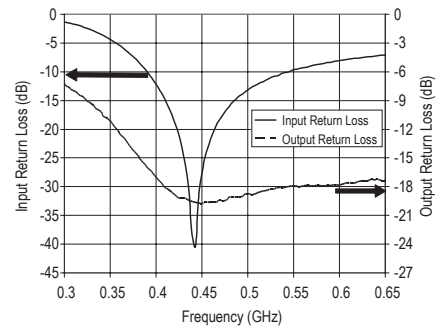

Figure 24. Input and output Return Loss vs Frequency

MGA-631P8 Typical Performance for 1.5 GHz Matching [7]

$T_A = +25\text{ }^\circ\text{C}$, $V_d = 4\text{V}$, $I_d = 60\text{mA}$

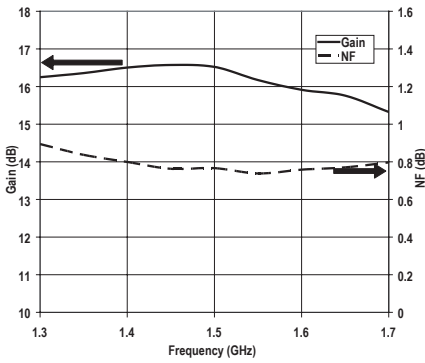

Figure 25. Gain and NF vs Frequency

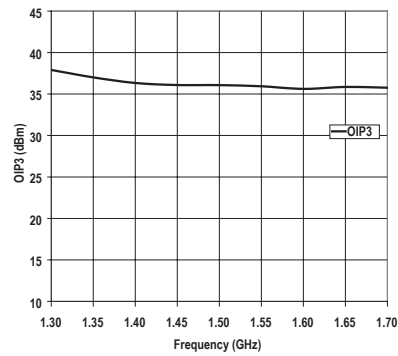

Figure 26. OIP3 vs Frequency

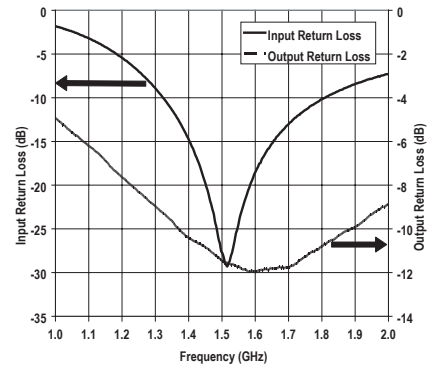

Figure 27. Input and output Return Loss vs Frequency

Notes:

[6] For Figure 22, 23 and 24, measurements obtained using demo board described in Figure28 and Table 1, List 2.

[7] For Figure 25, 26 and 27, measurements obtained using demo board described in Figure28 and Table 1, List 3.

Demo Board Layout

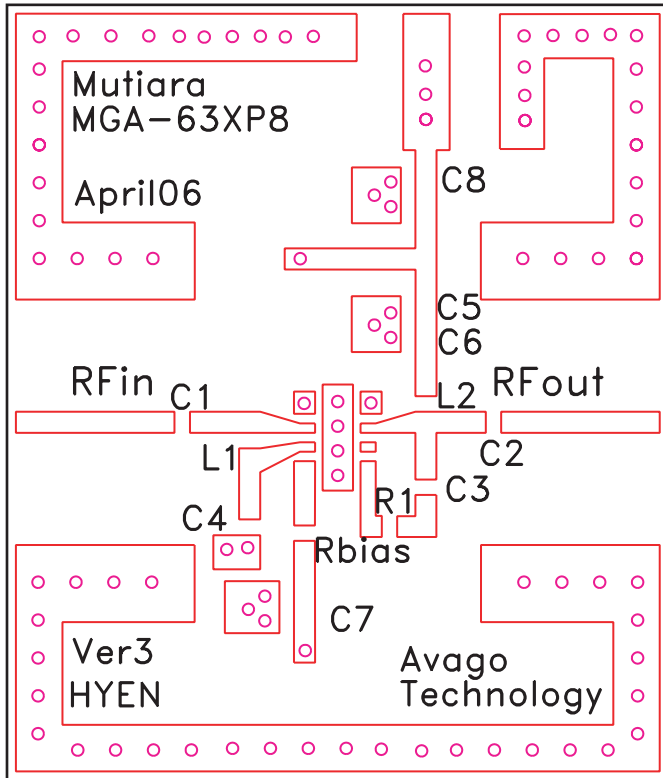

Figure 28. Demo Board Layout Diagram

- Recommended PCB material is 10 mils Rogers RO4350.
- Suggested component values may vary according to layout and PCB material.

Demo Board Schematic for Table 1, List 1 (900 MHz Matching) and List 2 (450 MHz Matching).

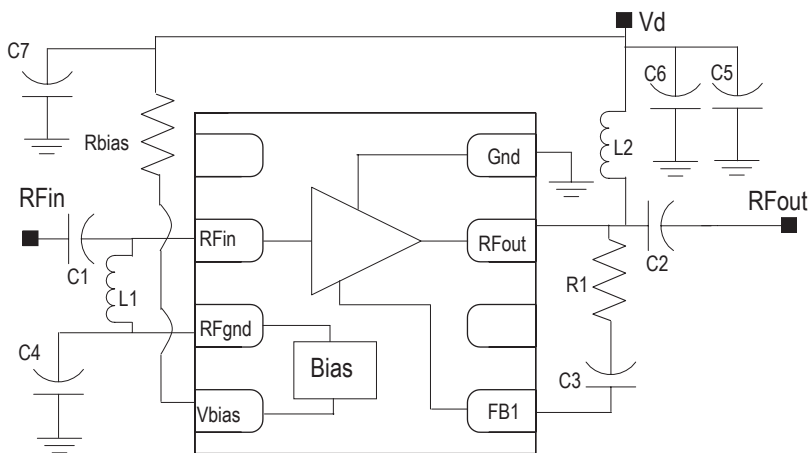

Figure 29. Demo Board Schematic. This demo board is used for measuring Electrical Specifications and plots of Fig. 4 to Fig. 24. Table 1, List 1 shows the components values used while measuring Fig. 4 to Fig. 21. Table 1, List 2 shows the components values used while measuring Fig. 22 to Fig. 24.

Demo Board Schematic for Table 1, List 3 (1.5 GHz Matching)

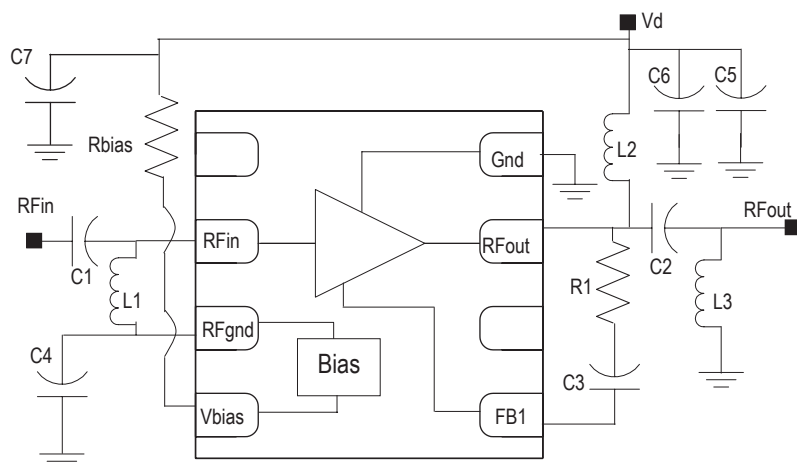

Figure 30. Demo Board Schematic with additional shunt inductor, L3, at RFout. This demo board is used for measuring plots of Fig. 25 to Fig. 27. Table1, List 3 shows the components values.

Table 1

- List 1 – Demo board component values for Demo board Schematic of Fig. 29. These component values are used when measuring Electrical Specifications and plots of Fig. 4 to Fig. 21.
- List 2 – Demo Board Component values for Demo board Schematic of Fig. 29. These component values are used while measuring plots of Fig. 22 to Fig. 24.
- List 3 – Demo Board Component values for Demo board Schematic of Fig. 30. These component values are used while measuring plots of Fig. 25 to Fig. 27.

Part	Size	List 1 (900 MHz Matching)	List 2 (450 MHz Matching)	List 3 (1.5 GHz Matching)
L1	0402	13.0nH (Coilcraft 0402CS-13NXJBW)	27.0nH (Toko LL1005-FHL27NS)	4.7nH (Toko LL1005-FHL4N7S)
L2	0402	18.0nH (Coilcraft 0402CS-18NXJBW)	27.0nH (Toko LL1005-FHL27NS)	18.0nH (Toko LL1005-FHL18NS)
L3	0402	Not Placed	Not Placed	6.8nH (Toko LL1005-FHL6N8S)
C1	0402	2.4pF (Rohm MCH155A024CK)	3.9pF (Rohm MCH155A3R9JK)	1.5pF (Rohm MCH155A1R5CK)
C2	0402	100pF (Rohm MCH155A101JK)	100pF (Rohm MCH155A101JK)	100pF (Rohm MCH155A101JK)
C3	0402	5.6pF (Rohm MCH155A056CK)	5.6pF (Rohm MCH155A5R6CK)	5.6pF (Rohm MCH155A5R6CK)
C4	0402	100pF (Rohm MCH155A101JK)	100pF (Rohm MCH155A101JK)	100pF (Rohm MCH155A101JK)
C5	0402	0.1uF (Kyocera CM05X5R104K10AH)	0.1uF (Kyocera CM05X5R104K10AH)	0.1uF (Kyocera CM05X5R104K10AH)
C6	0402	9pF (Rohm MCH155A090DK)	9.0pF (Rohm MCH155A090DK)	9.0pF (Rohm MCH155A090DK)
C7	0402	0.1uF (Kyocera CM05X5R104K10AH)	0.1uF (Kyocera CM05X5R104K10AH)	0.1uF (Kyocera CM05X5R104K10AH)
R1	0402	91 Ω (Rohm MCR01MZSJ910)	56 Ω (Rohm MCR0 MZSJ560)	300 Ω (Rohm MCR01MZSJ301)

Load pull test set up

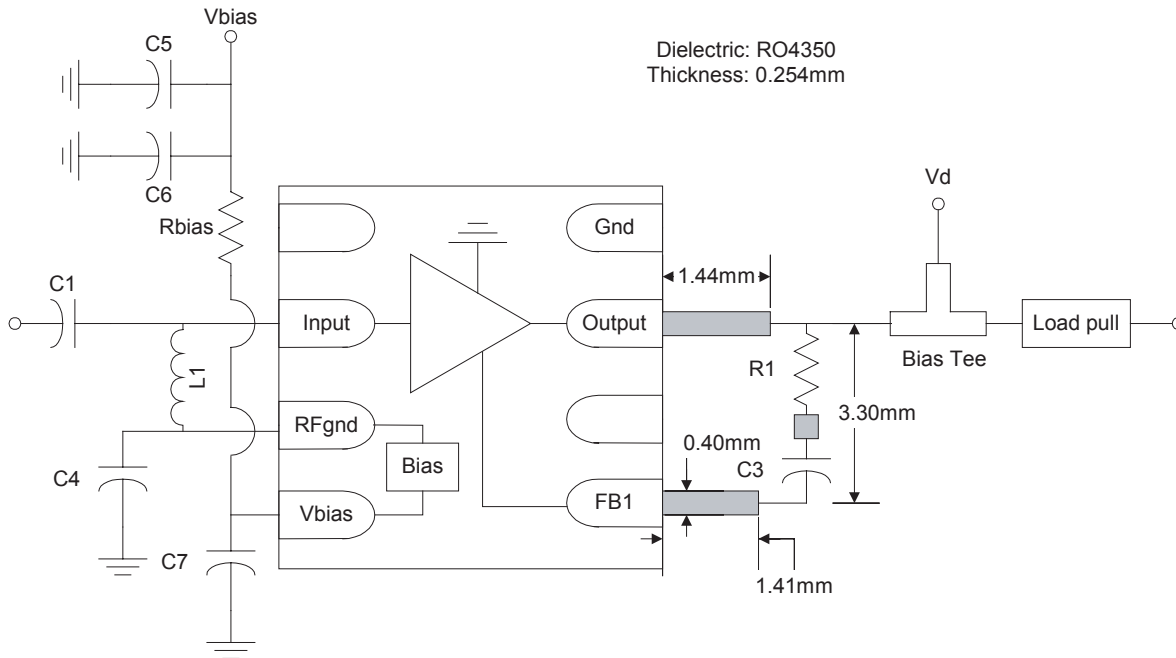

Figure 31. Test setup for load pull data

The input port is matched for good NF and IRL. Because of the high reverse isolation, any change on the output port has a minimum change on the input port. Therefore, only the output port is tuned for the maximum OIP3. R1 is varied for different level of gain Test condition for the OIP3: -20dBm at 900MHz \pm 5MHz.

Measured results

Test condition: 4V/60mA, 900MHz

Refer to Table 1, List 1 for SMT component value and description, unless otherwise stated.

Resistor, R1	Γ	OIP3 (max)
91ohm	0.81 < 44.3o	+39.0dBm
56ohm	0.65 < 94.2o	+34.2dBm
560ohm	0.38 < 85.2o	+38.7dBm

Fixed Load Pull

Freq = 0.9000 GHz

Ip3 max = 38.99 dBm
at 0.8053 < 44.31
10 contours, 1.00 dBm step
(29.00 to 38.00 dBm)

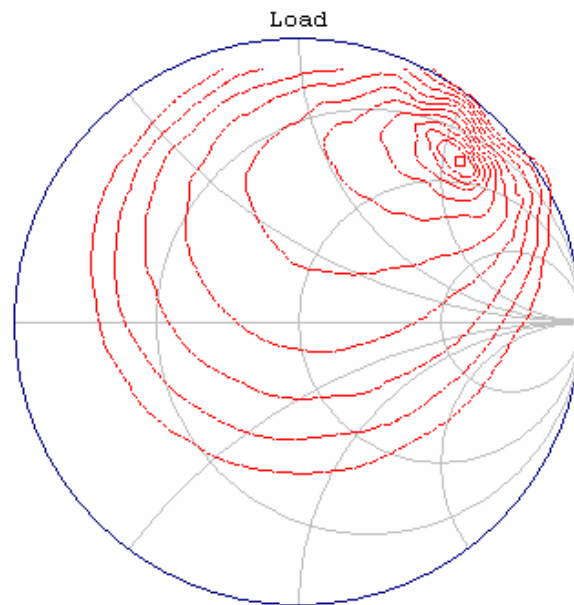

Figure 32. Load pull contour plot for R1=91ohm

Fixed Load Pull
Freq = 0.9000 GHz

Ip3 max = 34.23 dBm
at 0.6500< 94.18
10 contours, 1.00 dBm step
(25.00 to 34.00 dBm)

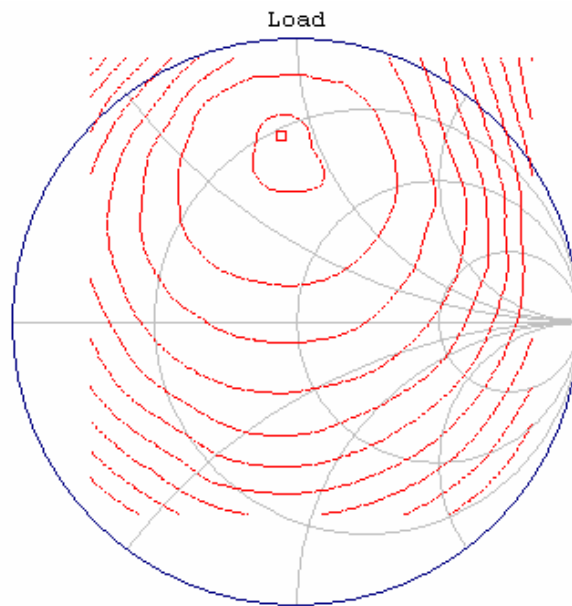

Figure 33. Load pull contour plot for R1=56ohm

Fixed Load Pull
Freq = 0.9000 GHz

Ip3 max = 38.70 dBm
at 0.3845< 85.21
10 contours, 1.00 dBm step
(29.00 to 38.00 dBm)

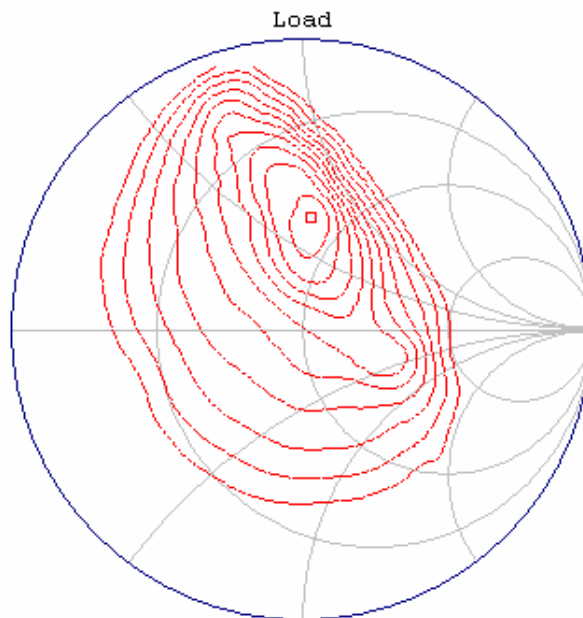
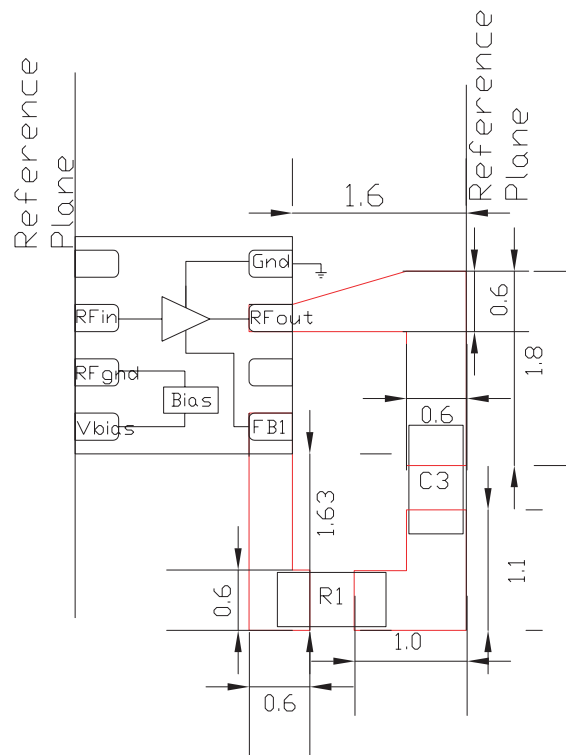

Figure 34. Load pull contour plot for R1=56ohm

MGA-631P8 Scattering Parameter and Noise Parameter Test Setup



Note: All dimensions are in mm.
PCB material is 10 mils Rogers RO4350.

Figure 35. Test Setup for S & Noise Parameters data, C3=5.6pF (Rohm MCH155A5R6CK)

Typical Noise Parameter, $V_d=4V$, $I_d=60mA$, applicable to any R1 due to high reverse isolation

Freq (GHz)	FMIN (dB)	GAMMA OPT		Rn/50
		Mag	Ang	
0.5	0.41	0.35	10	0.13
0.9	0.38	0.21	17.6	0.13
1.9	0.80	0.39	37.2	0.14
2.0	0.86	0.42	29.6	0.18
2.4	1.02	0.41	34.1	0.21
3.0	1.24	0.37	34.4	0.28

Notes:

1. Fmin values at 2 GHz and higher are based on measurements while the Fmins below 2 GHz have been extrapolated. The Fmin values are based on a set of 16 noise figure measurements made at 16 different impedances using an ATN NP5 test system. From these measurements a true Fmin is calculated.
2. S and noise parameters are measured on PCB. The PCB material is 10 mils Roger RO4350. Figure 35 shows the input and output reference plane.

MGA631P8 Typical Scattering Parameters, Vd=4V, Id=60m, R1=56ohm

Freq (GHz)	S11		S21		S12		S22	
	Mag	Ang	Mag	Ang	Mag	Ang	Mag	Ang
0.1	0.94	-11.1	23.02	155.7	0.003	47.9	0.63	-24.7
0.5	0.63	-25.3	10.46	117.6	0.011	48.7	0.37	-81.7
1.0	0.53	-23.4	5.38	110.3	0.014	37.1	0.30	-112.7
1.5	0.52	-25.0	3.59	113.4	0.015	39.5	0.27	-128.5
1.9	0.53	-28.7	2.92	118.6	0.016	35.0	0.27	-137.7
2.0	0.53	-29.7	2.76	118.7	0.016	35.3	0.27	-134.7
2.5	0.53	-34.8	2.45	122.6	0.015	34.0	0.29	-140.7
3.0	0.54	-40.0	2.09	125.5	0.015	34.9	0.33	-145.0
3.5	0.55	-44.7	1.93	128.3	0.016	36.7	0.38	-153.5
4.0	0.56	-48.5	1.71	130.9	0.017	32.4	0.44	-164.3
5.0	0.58	-56.9	1.53	132.4	0.022	28.7	0.48	167.6
6.0	0.61	-66.0	1.38	133.4	0.034	22.0	0.46	133.6
7.0	0.64	-77.7	1.33	132.4	0.053	11.5	0.39	87.3
8.0	0.71	-97.8	1.45	118.4	0.111	-8.7	0.28	1.6

MGA631P8 Typical Scattering Parameters, Vd=4V, Id=60m, R1=91ohm

Freq (GHz)	S11		S21		S12		S22	
	Mag	Ang	Mag	Ang	Mag	Ang	Mag	Ang
0.1	0.94	-10.9	22.91	156.2	0.008	65.8	0.61	-25.3
0.5	0.64	-24.8	10.73	121.3	0.009	44.3	0.33	-70.4
1.0	0.54	-23.8	6.02	113.0	0.012	34.1	0.28	-89.1
1.5	0.53	-26.2	4.14	112.0	0.013	37.2	0.30	-103.4
1.9	0.52	-29.4	3.28	114.2	0.014	33.7	0.34	-115.7
2.0	0.53	-30.3	3.09	113.4	0.013	36.8	0.35	-116.6
2.5	0.53	-35.4	2.64	116.1	0.013	34.3	0.40	-130.4
3.0	0.53	-40.0	2.12	118.9	0.013	35.8	0.44	-141.6
3.5	0.54	-44.2	1.90	122.7	0.014	36.4	0.47	-153.9
4.0	0.55	-48.2	1.64	126.5	0.015	34.4	0.49	-166.2
5.0	0.58	-56.5	1.47	130.3	0.022	30.5	0.51	165.7
6.0	0.61	-65.8	1.34	132.4	0.033	23.2	0.48	132.7
7.0	0.64	-77.6	1.30	132.0	0.052	13.4	0.40	88.2
8.0	0.71	-97.5	1.42	118.0	0.111	-7.9	0.29	5.2

Notes:

1. S-parameters are measured on PCB. The PCB material is 10 mils Roger RO4350. Figure 35 shows the input and output reference plane.

MGA631P8 Typical Scattering Parameters, Vd=4V, Id=60m, R1=300ohm

Freq (GHz)	S11		S21		S12		S22	
	Mag	Ang	Mag	Ang	Mag	Ang	Mag	Ang
0.1	0.93	-10.1	22.64	158.5	0.003	28.6	0.59	-18.6
0.5	0.67	-24.0	12.70	126.7	0.006	37.0	0.42	-34.6
1.0	0.57	-26.6	7.55	112.4	0.007	36.2	0.47	-59.4
1.5	0.53	-28.5	5.09	106.7	0.008	43.5	0.52	-83.0
1.9	0.52	-31.7	3.85	106.4	0.008	45.9	0.54	-99.8
2.0	0.52	-32.4	3.59	104.9	0.009	47.1	0.55	-103.5
2.5	0.52	-36.7	3.00	107.1	0.009	40.4	0.57	-121.8
3.0	0.53	-40.6	2.26	108.9	0.010	39.0	0.59	-136.7
3.5	0.54	-45.0	1.96	113.2	0.011	43.6	0.60	-151.2
4.0	0.55	-48.5	1.64	118.1	0.013	36.8	0.61	-165.0
5.0	0.57	-56.5	1.42	123.5	0.020	27.8	0.57	166.4
6.0	0.60	-65.8	1.29	127.3	0.033	19.7	0.52	134.9
7.0	0.64	-77.8	1.27	127.1	0.052	10.9	0.41	93.3
8.0	0.71	-99.2	1.37	112.5	0.108	-7.4	0.26	14.4

MGA631P8 Typical Scattering Parameters, Vd=4V, Id=60m, R1=560ohm

Freq (GHz)	S11		S21		S12		S22	
	Mag	Ang	Mag	Ang	Mag	Ang	Mag	Ang
0.1	0.93	-9.5	22.87	160.4	0.002	61.7	0.60	-13.3
0.5	0.69	-24.3	13.48	126.6	0.004	44.7	0.50	-31.3
1.0	0.56	-26.9	7.90	111.2	0.005	44.5	0.54	-57.9
1.5	0.53	-29.0	5.29	105.1	0.007	48.3	0.56	-81.7
1.9	0.51	-31.5	3.97	104.8	0.007	48.9	0.59	-98.7
2.0	0.52	-32.4	3.70	103.0	0.008	46.4	0.60	-102.5
2.5	0.52	-36.4	3.08	105.3	0.008	45.0	0.62	-120.9
3.0	0.53	-40.6	2.31	106.9	0.010	42.6	0.62	-136.1
3.5	0.54	-44.6	2.00	111.5	0.011	40.1	0.63	-150.5
4.0	0.55	-48.1	1.65	116.2	0.013	36.6	0.63	-164.1
5.0	0.57	-56.6	1.43	121.6	0.020	26.9	0.60	167.5
6.0	0.60	-65.6	1.30	125.5	0.033	19.9	0.53	136.4
7.0	0.64	-77.0	1.29	125.5	0.052	9.8	0.40	95.6
8.0	0.71	-98.0	1.40	109.4	0.107	-8.9	0.22	17.0

Notes:

1. S-parameters are measured on PCB. The PCB material is 10 mils Roger RO4350. Figure 35 shows the input and output reference plane.

Ordering Information

Part Number	No. of Devices	Container
MGA-631P8-TR1G	3000	7" Reel
MGA-631P8-TR2G	10000	13" Reel
MGA-631P8-BLKG	100	antistatic bag

TSLP2X2 Package Dimension

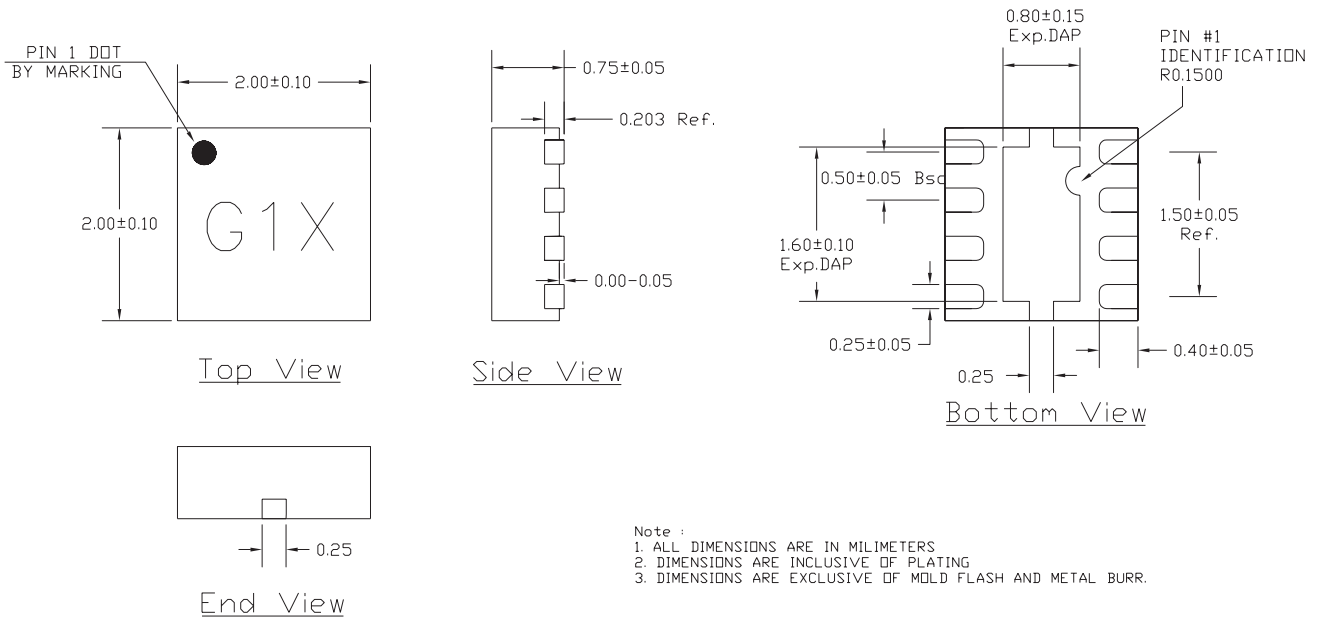

PCB Land Pattern and Stencil Design

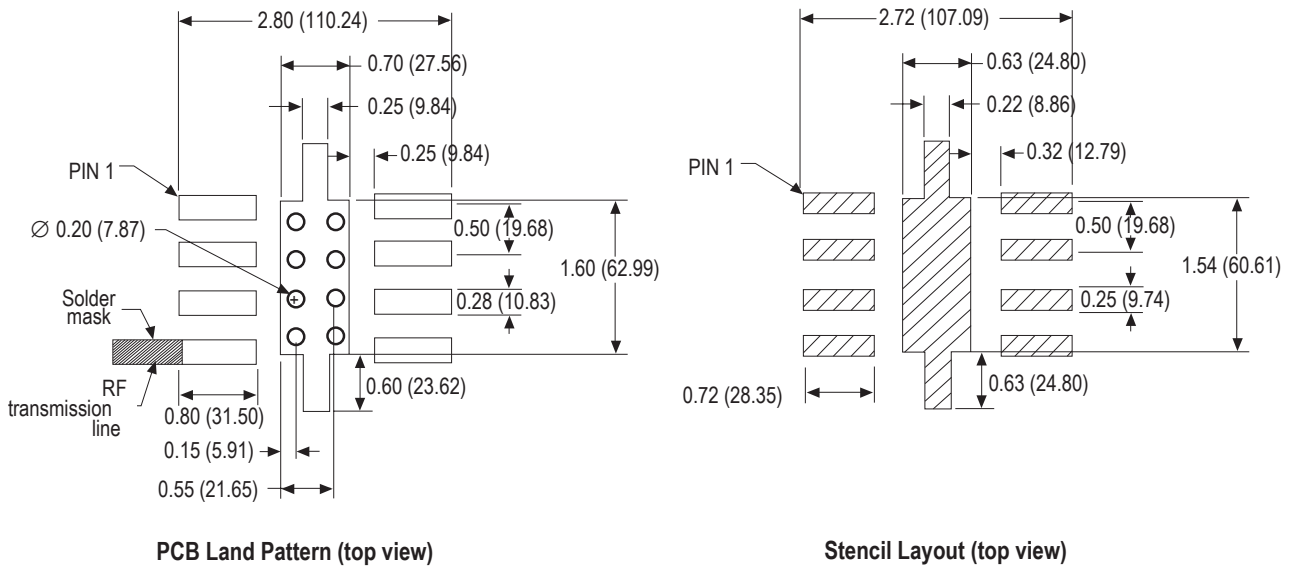

All dimensions are in millimeters (mils)
 Note: 1 mil = 1/1000 inch

Device Orientation

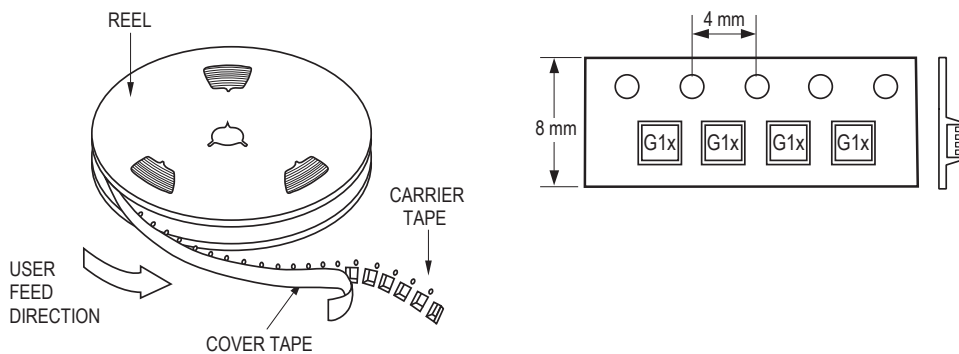

Tape Dimensions

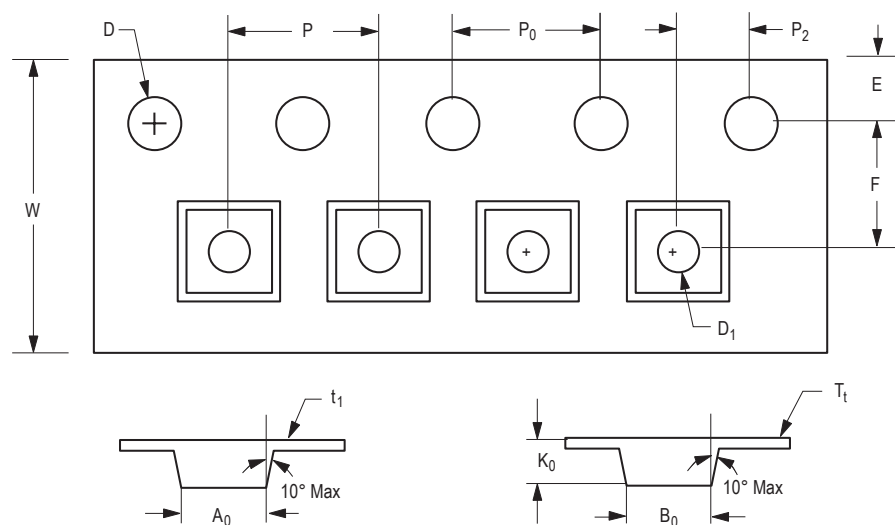

DESCRIPTION		SYMBOL	SIZE (mm)	SIZE (inches)
CAVITY	LENGTH	A_0	2.30 ± 0.05	0.091 ± 0.004
	WIDTH	B_0	2.30 ± 0.05	0.091 ± 0.004
	DEPTH	K_0	1.00 ± 0.05	0.039 ± 0.002
	PITCH	P	4.00 ± 0.10	0.157 ± 0.004
	BOTTOM HOLE DIAMETER	D_1	$1.00 + 0.25$	$0.039 + 0.002$
PERFORATION	DIAMETER	D	1.50 ± 0.10	0.060 ± 0.004
	PITCH	P_0	4.00 ± 0.10	0.157 ± 0.004
	POSITION	E	1.75 ± 0.10	0.069 ± 0.004
CARRIER TAPE	WIDTH	W	$8.00 + 0.30$ 8.00 ± 0.10	0.315 ± 0.012 0.315 ± 0.004
	THICKNESS	t_1	0.254 ± 0.02	0.010 ± 0.0008
COVER TAPE	WIDTH	C	5.4 ± 0.10	0.205 ± 0.004
	TAPE THICKNESS	T_t	0.062 ± 0.001	0.0025 ± 0.0004
DISTANCE	CAVITY TO PERFORATION (WIDTH DIRECTION)	F	3.50 ± 0.05	0.138 ± 0.002
	CAVITY TO PERFORATION (LENGTH DIRECTION)	P_2	2.00 ± 0.05	0.079 ± 0.002

For product information and a complete list of distributors, please go to our web site: www.avagotech.com

Avago, Avago Technologies, and the A logo are trademarks of Avago Technologies, Limited in the United States and other countries. Data subject to change. Copyright © 2007 Avago Technologies Limited. All rights reserved. Obsoletes AV01-0674EN AV02-0174EN - March 12, 2007

AVAGO
TECHNOLOGIES