

SwitchNet™ HW Series Control Units

216 Models of 22mm Control Units Contain an AS-Interface Chip

- AS-Interface Ver. 2.1 compliant, capable of connecting 62 slaves
- Signals and power are carried through two wires.
- Wire length can be extended to 300m by using two repeaters.
- Spring clamp terminals save wiring time.
- Available models include pushbuttons, pilot lights, illuminated pushbuttons, selector switches, key switches and illuminated selector switches.
- Illuminated units can change brightness in four levels: 100%, 50%, 25% and 12.5%.
- The operators and mounting hole dimensions are identical with standard HW series control units.
- Degree of protection: IP65 (from front of the panel)
- IEC62026-2 compliant



PLCs

Operator Interfaces

Part Numbers

HW Series

Non-illuminated Pushbuttons	Style	Operation	Part Numbers	Button Color Code
	Round Flush	Momentary	HW1B-M1A110S⓪	B (black) G (green) R (red) S (blue) W (white) Y (yellow) In place of ⓪, specify a button color code.
		Maintained	HW1B-A1A110S⓪	
	Round Extended	Momentary	HW1B-M2A110S⓪	
		Maintained	HW1B-A2A110S⓪	
	Mushroom 29mm	Momentary	HW1B-M3A110S⓪	
		Maintained	HW1B-A3A110S⓪	
	Mushroom 40mm	Momentary	HW1B-M4A110S⓪	
		Maintained	HW1B-A4A110S⓪	
	Square Flush	Momentary	HW2B-M1A110S⓪	
		Maintained	HW2B-A1A110S⓪	
	Square Extended	Momentary	HW2B-M2A110S⓪	
		Maintained	HW2B-A2A110S⓪	

Automation Software

Power Supplies

Sensors

Pilot Lights	Style	Part Numbers	Lens Color Code	Note
	Round Flush	HW1P-1A101S4⓪-T	A (amber) G (green) R (red) S (blue) W (white) Y (yellow) In place of ⓪, specify a lens color code.	One LED lamp is included: LSTD-2⓪. For dimensions, see page 275.
	Square Flush	HW2P-1A101S4⓪-T		

Communication & Networking

HW Series

PLCs	Operator Interfaces	Automation Software	Illuminated Pushbuttons	Style	Operation	Part Numbers	Lens Color Code	Note
				Round Flush	Momentary	HW1L-M1A111S4②	A (amber) G (green) R (red) S (blue) W (white) Y (yellow) In place of ②, specify a lens color code.	One LED lamp is included: LSTD-2②.
					Maintained	HW1L-A1A111S4②		
				Round Extended	Momentary	HW1L-M2A111S4②		
					Maintained	HW1L-A2A111S4②		
				Round Extended with Full Shroud	Momentary	HW1L-MF2A111S4②		
					Maintained	HW1L-AF2A111S4②		
				Mushroom 29mm	Momentary	HW1L-M3A111S4②		
					Maintained	HW1L-A3A111S4②		
				Mushroom 40mm	Momentary	HW1L-M4A111S4②		
					Maintained	HW1L-A4A111S4②		
				Square Flush	Momentary	HW2L-M1A111S4②		
					Maintained	HW2L-A1A111S4②		







Power Supplies	Selector Switches	Style	Operation	Part Numbers	Note	
		Knob	90° 2-position	Maintained	HW1S-2A110S	3-position selector switches use two AS-Interface blocks.
				Spring Return from Right	HW1S-21A110S	
			45° 3-position	Maintained	HW1S-3A220XS	
				Spring Return from Right	HW1S-31A220XS	
				Spring Return from Left	HW1S-32A220XS	
				Spring Return Two-way	HW1S-33A220XS	

Sensors	Key Switches	Style	Operation	Part Numbers	Key Retained Position Code	
		Key	90° 2-position	Maintained	HW1K-2③A110S	A, B, C
				Spring Return from Right	HW1K-21BA110S	–
			45° 3-position	Maintained	HW1K-3③A220XS	A, B, C, D, E, G, H
				Spring Return from Right	HW1K-31③A220XS	B, D, G
				Spring Return from Left	HW1K-32③A220XS	C, D, H
				Spring Return Two-way	HW1K-33DA220XS	–

1. In place of ③ in the part number, specify a key retained position code from the table below.
2. 3-position selector switches use two communication blocks.
3. For dimensions, see page 275.









Key Retained Position Code

90° 2-position			45° 3-position						
A	B	C	A	B	C	D	E	G	H
Not retained	Right retained	Left retained	Not retained	Right retained	Left retained	Right/Left retained	Center retained	Center/Right retained	Center/Left retained

Style	Operation	Part Numbers	Lens Color Code
 Knob	90° 2-position	Maintained 	HW1F-2A111S4②
		Spring Return from Right 	HW1F-21A111S4②
	45° 3-position	Maintained 	HW1F-3A221XS4②
		Spring Return from Right 	HW1F-31A221XS4②
		Spring Return from Left 	HW1F-32A221XS4②
		Spring Return Two-way 	HW1F-33A221XS4②

- 1. In place of ② in the part number, specify a lens color code.
- 2. 3-position selector switches use two communication blocks.
- 3. One LED lamp is included: LSTD-2②.
- 4. For dimensions, see page 275.

Accessories

Name & Appearance	Application/Specification	Part Numbers	Remarks	
T-branch Connector 	Connects AS-Interface flat cable to 2-wire cable	LA9Z-SNTB	Current capacity 3A For wiring instructions, see page 275.	
Hand-held Programming Device 	Assigns slave addresses and monitors system configuration	SX9Z-ADR1N	Contains: <ul style="list-style-type: none"> • Programming device cable (SX9Z-CN1) • Programming device AC adapter (SX9Z-ADPT) • SwitchNet addressing port adapter (LA9Z-SNADP) • Operating manual (English/Japanese) 	
Programming Device Cable 	Connects programming device to slave	SX9Z-CN1	Included with hand-held programming device SX9Z-ADR1N	
Programming Device AC Adapter 	Charges programming device	SX9Z-ADPT	AC input voltage: 100-240V AC Included with hand-held programming device SX9Z-ADR1N	
SwitchNet Addressing Port Adapter 	Connects programming device cable to SwitchNet communication blocks	LA9Z-SNADP	Included with hand-held programming device SX9Z-ADR1N	
Tools	Locking Ring Wrench	Made of metal Weight: Approx. 150g	MW9Z-T1	Used to tighten the plastic locking ring. 
	Lamp Holder Tool	Made of rubber	OR-55	Used to remove and install LED lamps. 
	Wiring Screwdriver	Weight: Approx. 20g	BC1S-SD0	Used to wire spring clamp terminals. 
Anti-rotation Ring 	Made of plastic	HW9Z-RL	Prevents rotation of control unit in mounting hole. 	
Rubber Mounting Hole Plug 	Black rubber	OB-31	For plugging unused 22mm mounting holes in panel. 	
Metallic Mounting Hole Plug 	Diecast metal (Locking ring: plastic)	LW9Z-BM	<ul style="list-style-type: none"> • For plugging unused 22mm mounting holes in panel. • Tighten the attached locking ring to a torque of 1.2 N·m. • Degree of protection: IP66 	

PLCs

Operator Interfaces

Automation Software

Power Supplies

Sensors

Communication & Networking

HW Series Replacement Parts

Name & Appearance		Part Numbers	Remarks
Marking Plate 	Round Flush	HW9Z-P11	Color: white
	Round Extended	HW9Z-P12	
	Square Flush	HW9Z-P21	
	29/40mm Mushroom	ALW3B	
Illuminated Selector Knob 		HW9Z-FDYⓈ	In place of Ⓢ, specify a lens color code. A (amber) G (green) R (red) S (blue) W (white) Y (yellow)
Replacement Key 	For key switch	HW9Z-SKP	
Locking Ring 		HW9Z-LN	Black
Safety Lever Lock 		HWLS-TK1971	Yellow

PLCs

Operator Interfaces

Automation Software

LED Lamp

Rated Voltage	Current Draw	Part Number	Lens Color Code
24V AC/DC ±10%	10mA AC 11mA DC	LSTD-2Ⓢ	A (amber), G (green), R (red), S (blue), W (white), Y (yellow) In place of Ⓢ, specify a lens color code.

Power Supplies

HW Nameplates

Name	Specifications	Part Number	Notes/Dimensions
HWAM Nameplate	Without legend plate Made of black plastic 1.5mm thick	HWAM	Order a legend plate HWNP-Ⓢ separately.
HWAQ Nameplate	Without legend plate Made of black plastic 1.5mm thick	HWAQ	Order a legend plate HWNP-Ⓢ separately.

Sensors



Ⓢ Specify engraving of nameplate on page 272.

Legend Plate

Name	Specifications	Part Number	Notes/Dimensions
HWNP Legend Plate	Black aluminum plate 1.0mm thick	HWNP-④	White letter on black background. In place of ④, specify legend code from table below. 

④ Standard Legend Codes

Pushbuttons				Pushbuttons/Selector Switches				Selector Switches	
Legend	Code	Legend	Code	Legend	Code	Legend	Code	Legend	Code
AUTO	101	OPEN	116	AUTO-MAN	201	REV-FOR	216	AUTO-MAN-OFF	301
CLOSE	102	OUT	117	CLOSE-OPEN	202	RUN-JOG	217	AUTO-OFF-MAN	302
DOWN	103	RAISE	118	DOWN-UP	203	RUN-SAFE	218	CLOSE-OFF-OPEN	303
EMERG.STOP	104	RESET	119	FAST-SLOW	204	SAFE-RUN	219	DOWN-OFF-SLOW	304
FAST	105	REVERSE	120	FOR-REV	205	SLOW-FAST	220	FAST-OFF-SLOW	305
FORWARD	106	RUN	121	HAND-AUTO	206	START-STOP	221	FOR-OFF-REV	306
HAND	107	SLOW	122	HIGH-LOW	207	STOP-START	222	LEFT-OFF-RIGHT	307
HIGH	108	START	123	JOG-RUN	208	UP-DOWN	223	LOWER-OFF-RAISE	308
IN	109	STOP	125	LEFT-RIGHT	209	OI (Int'l OFF ON)	250	OFF-MAN-AUTO	309
INCH	110	TEST	126	LOWER-RAISE	210			OFF-SLOW-FAST	310
JOG	111	UP	127	MAN-AUTO	211			OFF-1-2	311
LOW	112	I (Int'l On)	150	OFF-ON	212			OPEN-OFF-CLOSE	312
LOWER	113	O (Int'l Off)	151	ON-OFF	213			SLOW-OFF-FAST	313
OFF	114	EMO	152	OPEN-CLOSE	214			SUMMER-OFF-WINTER	314
ON	115			RAISE-LOWER	215			UP-OFF-DOWN	315
								1-OFF-2	316
								HAND-OFF-AUTO	317

-  To order engraved nameplates, add legend code to nameplate part number.
- Character height based on the number of characters and size of nameplate. Standard character size is 3/16".
- Nameplates with standard legends are the same list price as blank nameplates.
- Nameplates have built-in anti-rotation feature for use with notched panel cut-outs. Additional anti-rotation ring (HW9Z-RL) is not necessary.

- Fig. 1 shows the procedure to install the legend plate into the nameplate.
- Fig. 2 shows how to remove the legend plate from the nameplate. Insert a thin screwdriver into the top of the legend plate to remove the legend plate.
- When using the nameplate, the applicable panel thickness reduces by 1.5mm, the thickness of the nameplate.
- When anti-rotation is not necessary and the recess is not provided in the mounting hole, break the anti-rotation tab off the nameplate as shown in Fig. 2.

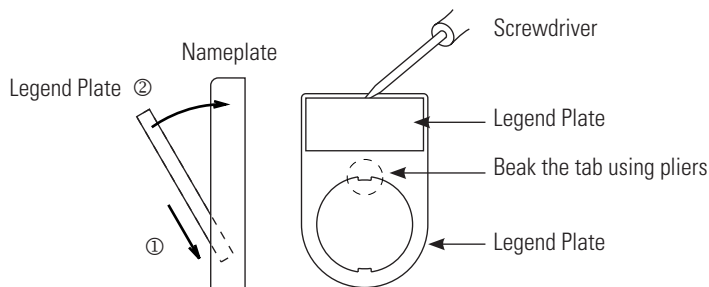

Specifications

General Specifications

Operating Voltage	26.5 to 31.6V DC
Maximum Input Current	Pushbutton, selector 2-position, key 2-position: 16mA Pilot light, illuminated PB, illuminated selector 2-position: 25mA Selector 3-position, key 3-position: 32mA (2 slaves: 1-in slave 16mA) Illuminated selector 3-position: 41mA (2 slaves: 1-in slave 16mA, 1-in/1-out slave 25mA)
Dielectric Strength	Between AS-Interface terminal and dead parts: 500V AC, 1 minute
Insulation Resistance	Between AS-Interface terminal and dead parts: 100 MΩ minimum (500V DC megger)
Operating Temperature	-25 to +55°C (no freezing)
Storage Temperature	-40 to +80°C (no freezing)
Operating Humidity	95% RH maximum (non-condensing)
Altitude	Operate: 2000m maximum, Transport: 3000m maximum
Pollution Degree	3 (IEC60664)
Degree of Protection	IP65
Corrosion Immunity	Atmosphere free from corrosive gases
Vibration Resistance	5 to 55 Hz amplitude 0.5mm, 50 m/s ² (5G) 1 hour per axis on each of three mutually perpendicular axes
Shock Resistance	1000 m/s ² (100G), 5 shocks on each of three mutually perpendicular axes
Weight	Approx. 40g (3-position selector switches: approx. 44g)

PLCs

Operator Interfaces

Communication Specifications

Applicable Standard	AS-Interface Ver. 2.1
Slave Profile	I/O code/ID code/ID2 code: B/A/E
Occupied Slave Addresses	Pushbutton, pilot light, illuminated PB, selector 2-position (knob, key, illuminated): 1 slave address Selector 3-position (knob, key, illuminated): 2 slave addresses
Digital I/O Data Allocation	See page 274
Illumination Control	LED illumination brightness of SwitchNet units can be controlled using the Write_Parameter command. For Write_Parameter command and settings, see page 274.
AS-Interface Communication Specifications	Control system: Master/slave system Topology: Free topology Transmission medium: 2-wire cable Maximum slaves: 62 (A/B slaves), 31 (standard slaves) Maximum I/O points: 434 (A/B slaves), 248 (standard slaves) Maximum network length: 100m (without repeater) Maximum bus scan time: 10ms (62 A/B slaves), 5ms (31 standard slaves)

Automation Software

Power Supplies

Mechanical/Electrical Specifications

Terminal Style	Spring clamp
Applicable Wire	Parallel 2-wire cable (twisted pair cable not applicable) Single wires can also be used for connection over short distances. Stranded wire: 0.5 to 0.75mm ² (AWG20 to 18) Solid wire: 0.5 to 1.5mm ² (AWG20 to 16)
Mounting Hole Size	ø22.3mm, +0.4 or -0mm
Applicable LED Lamp	LSTD-2Ⓢ (rated current 10mA DC)
Mechanical Life	Momentary: 5,000,000 operations minimum Maintained, selector: 500,000 operations minimum Addressing port adapter durability: 100 insertions/removals minimum

Sensors

Certification

Certification	AS-International Association
Standards	UL listed, c-UL listed, CE marked

Communication & Networking

Digital I/O Data Allocation

Slave Unit	Used I/O	Communication Block Mounting Position	Input Data (slave send data)				Output Data (slave receive data)			
			DI3	DI2	DI1	DI0	DO3	DO2	DO1	DO0
Pushbutton	1 in	Ⓜ	0	X1	1	1	*	—	—	—
Pilot light	1 out	Ⓜ	0	0	1	1	*	—	—	X1
Illuminated pushbutton	1 in/1 out	Ⓜ	0	X1	1	1	*	—	—	X1
Selector, Key 2-position	1 in	Ⓜ	0	X2	1	1	*	—	—	—
Selector, Key 3-position	1 in	Ⓜ	0	X3	1	1	*	—	—	—
	1 in	Ⓜ	0	X3	1	1	*	—	—	—
Illuminated selector 2-position	1 in/1 out	Ⓜ	0	X2	1	1	*	—	—	X1
Illuminated selector 3-position	1 in	Ⓜ	0	X3	1	1	*	—	—	—
	1 in/1 out	Ⓜ	0	X3	1	1	*	—	—	X1

- In the above table, bits marked with X1, X2 and X3 are used.
- X1: When pushbutton is pressed, input data is 1 (on). When not pressed, input data is 0 (off). When output data is 1 (on), LED is on. When output data is 0 (off), LED is off.
- X2: The input data of 2-position selector switches depend on the operator position as shown below.
- X3: The input data of 3-position selector switches depend on the operator position as shown below.
- Unused input bits DI3 and DI2 are 0 (off) and unused input bits DI1 and DI0 are 1 (on). Slaves ignore unused output data sent from the master.
- *: The master uses bit DO3 for addressing A/B slaves.

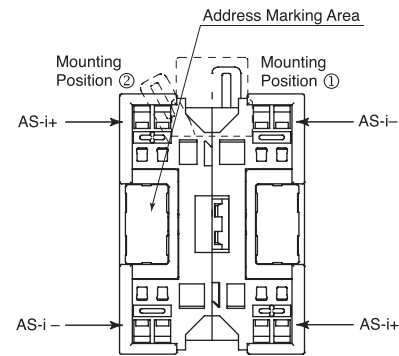
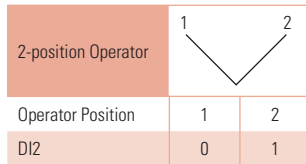

On 3-position selector switches and illuminated selector switches, communication blocks ① and ② are mounted in positions as shown above.

- X3: The input data of 3-position selector switches depend on the operator position as shown below.

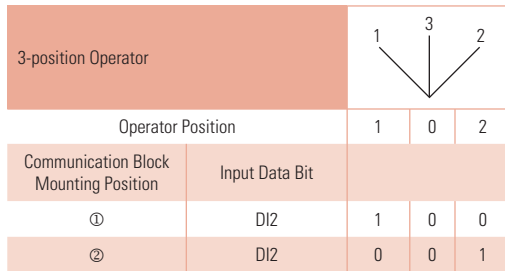
Write_Parameter Command

0	0	A4	A3	A2	A1	A0	1	Sel P3	P2	P1	P0	PB	1
---	---	----	----	----	----	----	---	--------	----	----	----	----	---

Write_Parameter Settings

LED Brightness	Settings			Remarks
	Output Selection	Control Data		
		P2	P1	
100%	1: DO0 0: DO1	1	1	Default
50%		0	1	
25%		1	0	
12.50%		0	0	

Dimensions (mm)

Pilot Lights
Illuminated Pushbuttons

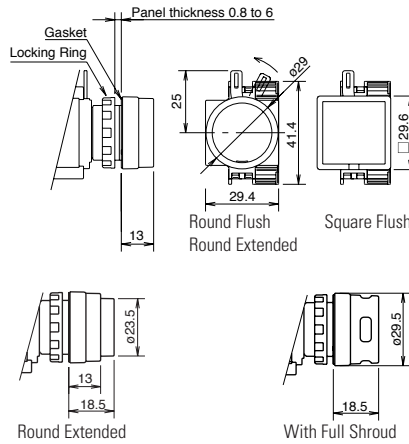
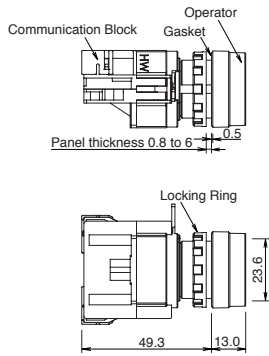

Selector Switch

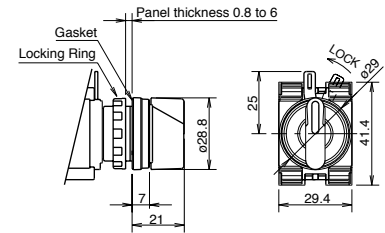

Key Switch

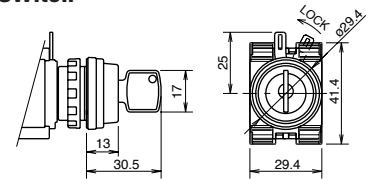

Pushbuttons

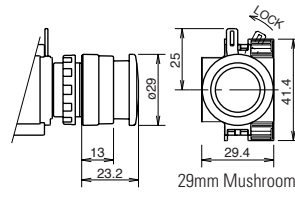
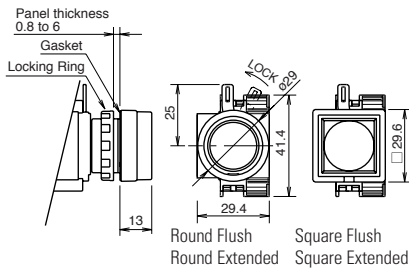

Illuminated Selector Switch

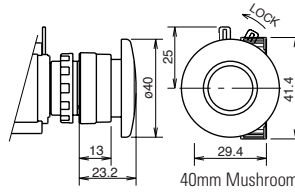
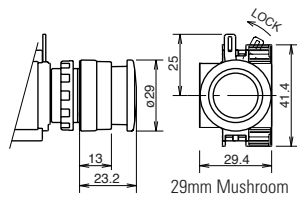
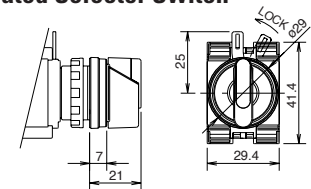

Panel Cut-out

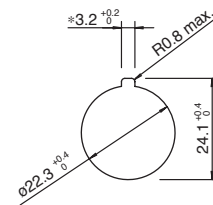

T-Branch Connector: LZ9Z-SNTB

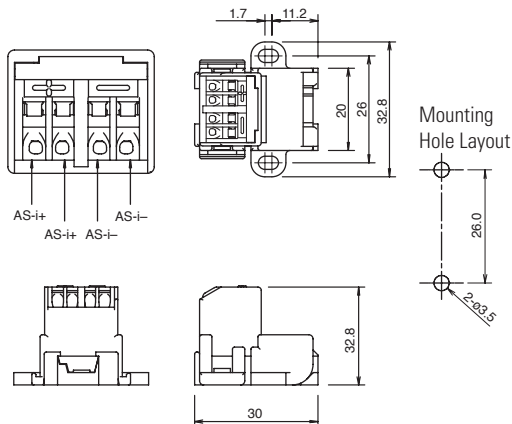

Wiring Instructions

1. Locate the wire hole on top of the T-branch connector. To open the spring clamp in the wire hole, insert an optional screwdriver (BC1S-SD0) diagonally into the adjoining screwdriver hole until it hits the bottom. Slightly jerk the screwdriver to insert easily.

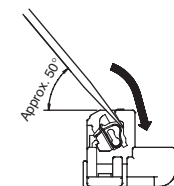

Screwdriver Tip According to DIN5264

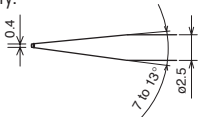

2. With the screwdriver held in the hole, insert a wire or ferrule to the bottom of the wire hole, then pull out the screwdriver.

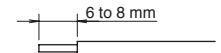

3. Strip the cable insulation 6 to 8mm from the end. When wiring with 0.75mm² or AWG18 stranded wires, use a ferrule to ensure a sufficient strength. If a stranded wire of this thickness is connected without using a ferrule, the wire strength is reduced.

PLCs

Operator Interfaces

Automation Software

Power Supplies

Sensors

Communication & Networking

Panel Mounting

Remove the AS-Interface communication block from the operator. Insert the operator into the panel cut-out from the front, then install the communication block to the operator.

Removing/Installing the Communication Block

Turn the locking lever on the communication block in the direction opposite to the arrow on the housing. Then the communication block can be removed.

To install the communication block, align the TOP markings on the communication block and the operator, and insert the communication block. Then, turn the locking lever in the direction of the arrow.

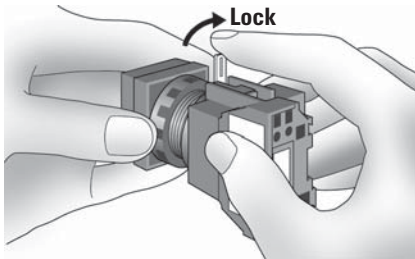

Notes for Panel Mounting

When mounting the operator onto a panel, use the optional locking ring wrench (MW9Z-T1) to tighten the locking ring. Recommended tightening torque is 2.0 N·m. Do not use pliers. Excessive tightening will damage the locking ring.

On pilot lights and illuminated pushbuttons, do not apply excessive force to the LED lamp installed in the unit. Otherwise the lamp base may be damaged.

Notes for Illuminated Pushbuttons with Full Shroud

The full shroud cannot be removed from the full shroud type operator.

Operating Instructions

Using the Safety Lever Lock

To make sure that the lock lever is in the locked position, use of the attached safety lever lock (HWLS-TK1971, yellow) is recommended.

Use the safety lever lock according to the instructions described below.

1. The minimum vertical mounting centers of HW control units are 50mm. Determine the mounting centers in consideration of convenience for installing the safety lever lock. (100mm is recommended.)
2. After mounting the HW units on a panel, turn the locking lever to the locked position and put on the safety lever lock.
3. When the HW units are mounted on mounting centers smaller than the recommended distance, first put on the safety lever lock with the locking lever unlocked and install the communication block onto the operator. Turn the lock lever into the locked position and push down the safety lever lock into place.
4. To remove the safety lever lock, insert a screwdriver into the hole in the safety lever lock and pull up the safety lever lock.

Installing/Removing the Safety Lever Lock

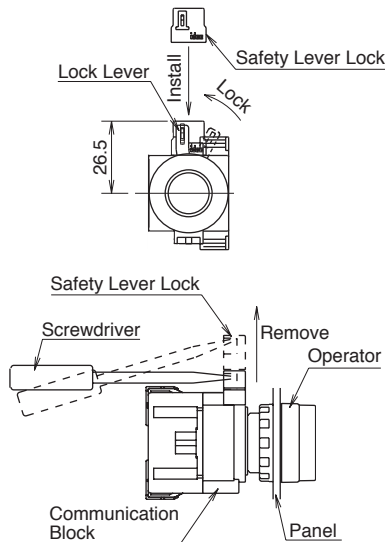

Replacement of the Lens and Marking Plate

1. To remove the lens unit (lens, marking plate and lens holder), insert a screwdriver into the recess of the lens. Recesses are on the side marked "TOP" and the opposite side.

Removing the Lens Unit

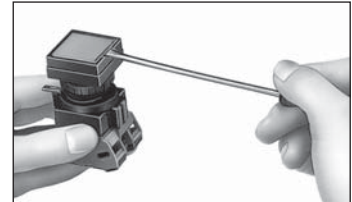

2. To remove the lens, insert a screwdriver between the lens and lens holder to disengage the latches. Then, the marking plate can be removed.

Removing the Lens

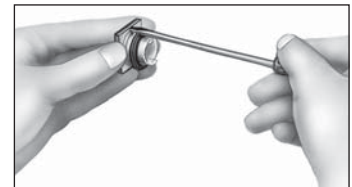

Note: The filter on the lens holder is for waterproof and oiltight purposes and cannot be removed.

Installation

For round lens models, place the marking plate on the lens holder with the anti-rotation projection engaged and press the lens onto the lens holder to engage the latches. For square lens models, insert the marking plate into the lens and press the lens onto the lens holder to engage the latches.

Pay attention to the orientation of the marking plate.

Round Lens

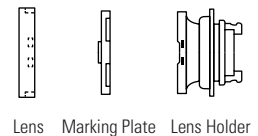

Square Lens

Note the orientation.

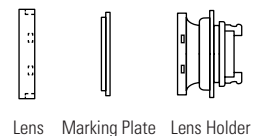

Legend Marking

For HW series pilot lights and illuminated pushbuttons, legends and symbols can be engraved on marking plates, or printed Mylar can be inserted under the lens for labeling purposes.

Marking Plate and Marking Film Size

Lens Style	Round Lens Type (Flush)	Square Lens Type
Built-in Marking Plate		
	<ul style="list-style-type: none"> Engraving must be made on the engraving area within 0.5mm deep. The marking plate is made of white acrylic resin. 	
Applicable Marking Film		
	<ul style="list-style-type: none"> Mylar for printing labels is not included and must be provided and printed by user. Two 0.1-mm-thick films or one 0.2-mm-thick film can be installed in the lens. Recommended marking film: Mylar 	

Insertion Order of Marking Plate and Film

Round Lens (Flush)

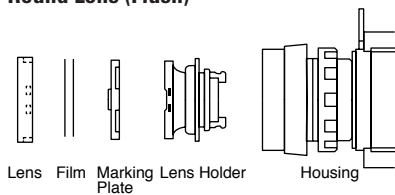

Note: Mylar is not included

Square Lens (Flush)

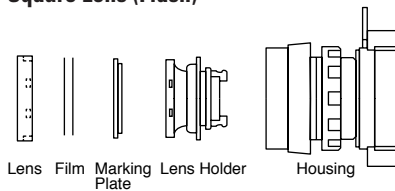

Note: Mylar is not included with the control unit. When using Mylar, place the marking plate in the reverse direction.

Replacement of LED Lamps

LED lamps can be replaced using the lamp holder tool (OR-55) from the front of the panel. The lamp can also be replaced by removing the communication block from the operator unit.

Replacement of Lamps from Panel Front

Removal

Push in and turn the LED lamp counterclockwise using the lamp holder tool, then the LED lamp can be removed.

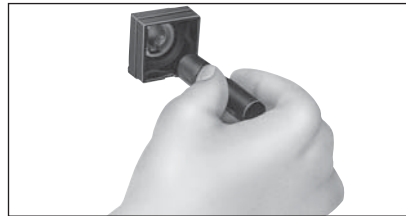

Installation

1. Insert the LED lamp into the lamp holder tool and hold the lamp as shown below.

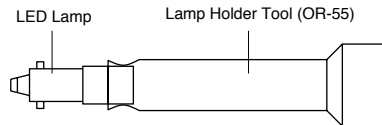

2. Align the contact pins of the lamp base with the grooves in the lamp receptacle in the operator unit, then push in the LED lamp lightly and turn it clockwise into place.

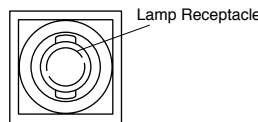

Wiring

1. Locate the wire hole in the back of the communication contact block. To open the spring clamp in the wire hole, insert an optional screwdriver (BC1S-SDD) into the adjoining screwdriver hole until it hits the bottom. Slightly jerk the screwdriver to insert wire easily.

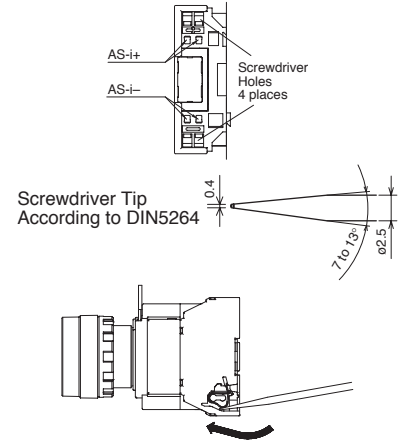

2. With the screwdriver held in the hole, insert a wire or ferrule to the bottom of the wire hole, then pull out the screwdriver.

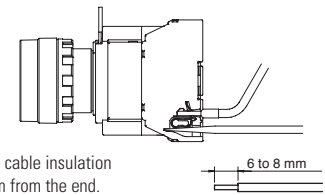

Strip the cable insulation 6 to 8mm from the end.

Anti-rotation Ring

When using the anti-rotation ring, align the TOP marking on the operator and the ▲ mark on the anti-rotation ring with the recess in the mounting hole.

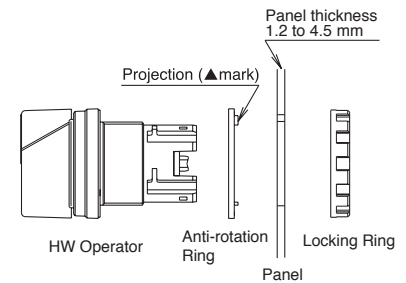

Panel Cut-out (IEC947-5-1)

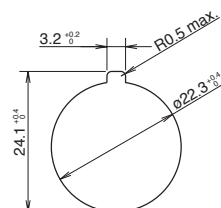

SwitchNet™ L6 Series Control Units

277 Models of 16mm Control Units Containing AS-Interface Chip

- AS-Interface Ver. 2.1 compliant, capable of connecting 62 slaves
- Signals and power are carried through two wires.
- The wire length can be extended to 300m by using two repeaters.
- Spring clamp terminals reduce wiring time.
- Available models include pushbuttons, pilot lights, illuminated pushbuttons, selector switches, key switches, illuminated selector switches and lever switches.
- Illuminated units can change the brightness in four levels: 100%, 50%, 25% and 12.5%.
- The operators and mounting hole dimensions are identical with standard L6 series control units.
- Degree of protection: IP65 (from front of the panel)
- IEC62026-2 compliant



Part Numbers

L6 Series

Non-illuminated Pushbuttons	Style	Operation	Part Numbers	Button Color Code
	Round	Momentary	LA1B-M1A1SⓄ	B (black) G (green) R (red) S (blue) W (white) Y (yellow) In place of Ⓞ, specify a button color code.
		Maintained	LA1B-A1A1SⓄ	
	Square	Momentary	LA2B-M1A1SⓄ	
		Maintained	LA2B-A1A1SⓄ	
	Rectangular	Momentary	LA3B-M1A1SⓄ	
		Maintained	LA3B-A1A1SⓄ	

Pilot Lights	Style	Part Numbers	Lens Color Code	Note
	Round	LA1P-1A04SⓂ	A (amber) G (green) R (red) S (blue) W (white) Y (yellow) In place of Ⓜ, specify a lens color code.	One LED lamp is included: LFTD-2Ⓜ.
Rectangular	LA3P-1A04SⓂ			

PLCs

Operator Interfaces

Automation Software

Power Supplies

Sensors

Communication & Networking

Illuminated Pushbuttons	Style	Operation	Part Numbers	Lens Color Code	Notes
	Round	Momentary	LA1L-M1A14S②	A (amber) G (green) R (red) S (blue) W (white) Y (yellow) In place of ②, specify a lens color code.	One LED lamp is included: LFTD-2②. For dimensions, see page 285.
		Maintained	LA1L-A1A14S②		
	Square	Momentary	LA2L-M1A14S②		
		Maintained	LA2L-A1A14S②		
	Rectangular	Momentary	LA3L-M1A14S②		
		Maintained	LA3L-A1A14S②		

PLCs

Operator Interfaces

Selector Switches	Style	Operation	Part Numbers
	Round	Maintained	LA1S-2A1S
		Spring Return from Right	LA1S-21A1S
		Maintained	LA1S-3A2S
		Spring Return from Right	LA1S-31A2S
		Spring Return from Left	LA1S-32A2S
		Spring Return Two-way	LA1S-33A2S
	Square	Maintained	LA2S-2A1S
		Spring Return from Right	LA2S-21A1S
		Maintained	LA2S-3A2S
		Spring Return from Right	LA2S-31A2S
		Spring Return from Left	LA2S-32A2S
		Spring Return Two-way	LA2S-33A2S
	Rectangular	Maintained	LA3S-2A1S
		Spring Return from Right	LA3S-21A1S
		Maintained	LA3S-3A2S
		Spring Return from Right	LA3S-31A2S
		Spring Return from Left	LA3S-32A2S
		Spring Return Two-way	LA3S-33A2S

Automation Software

Power Supplies

Sensors

Communication & Networking

PLCs

Operator Interfaces

Automation Software

Power Supplies

Sensors

Communication & Networking

Key Switches	Style	Operation		Part Numbers	Notes	
	Round	90° 2-position	Maintained		LA1K-2A1S [Ⓞ]	A, B, C
			Spring Return from Right		LA1K-21A1SB	–
		45° 3-position	Maintained		LA1K-3A2S [Ⓞ]	A, B, C, D, E, G, H
			Spring Return from Right		LA1K-31A2S [Ⓞ]	B, D, G
			Spring Return from Left		LA1K-32A2S [Ⓞ]	C, D, H
			Spring Return Two-way		LA1K-33A2SD	–
	Square	90° 2-position	Maintained		LA2K-2A1S [Ⓞ]	A, B, C
			Spring Return from Right		LA2K-21A1SB	–
		45° 3-position	Maintained		LA2K-3A2S [Ⓞ]	A, B, C, D, E, G, H
			Spring Return from Right		LA2K-31A2S [Ⓞ]	B, D, G
			Spring Return from Left		LA2K-32A2S [Ⓞ]	C, D, H
			Spring Return Two-way		LA2K-33A2SD	–
	Rectangular	90° 2-position	Maintained		LA3K-2A1S [Ⓞ]	A, B, C
			Spring Return from Right		LA3K-21A1SB	–
		45° 3-position	Maintained		LA3K-3A2S [Ⓞ]	A, B, C, D, E, G, H
			Spring Return from Right		LA3K-31A2S [Ⓞ]	B, D, G
			Spring Return from Left		LA3K-32A2S [Ⓞ]	C, D, H
			Spring Return Two-way		LA3K-33A2SD	–

In place of [Ⓞ] in the part number, specify a key retained position code from the table below.

Key Retained Position Code

90° 2-position			45° 3-position						
A	B	C	A	B	C	D	E	G	H
Not retained	Right retained	Left retained	Not retained	Right retained	Left retained	Right/Left retained	Center retained	Center/Right retained	Center/Left retained

Illuminated Selector Switches	Style	Operation		Part Numbers	Note	
	Round	90° 2-position	Maintained		LA1F-2A14S [Ⓞ]	A (amber) G (green) R (red) S (blue) W (white) Y (yellow) In place of [Ⓞ] in the part number, specify a lens color code.
			Spring Return from Right		LA1F-21A14S [Ⓞ]	
		45° 3-position	Maintained		LA1F-3A24S [Ⓞ]	
			Spring Return from Right		LA1F-31A24S [Ⓞ]	
			Spring Return from Left		LA1F-32A24S [Ⓞ]	
			Spring Return Two-way		LA1F-33A24S [Ⓞ]	
	Square	90° 2-position	Maintained		LA2F-2A14S [Ⓞ]	
			Spring Return from Right		LA2F-21A14S [Ⓞ]	
		45° 3-position	Maintained		LA2F-3A24S [Ⓞ]	
			Spring Return from Right		LA2F-31A24S [Ⓞ]	
			Spring Return from Left		LA2F-32A24S [Ⓞ]	
			Spring Return Two-way		LA2F-33A24S [Ⓞ]	
	Rectangular	90° 2-position	Maintained		LA3F-2A14S [Ⓞ]	
			Spring Return from Right		LA3F-21A14S [Ⓞ]	
		45° 3-position	Maintained		LA3F-3A24S [Ⓞ]	
			Spring Return from Right		LA3F-31A24S [Ⓞ]	
			Spring Return from Left		LA3F-32A24S [Ⓞ]	
			Spring Return Two-way		LA3F-33A24S [Ⓞ]	

One LED lamp is included: LFTD-2[Ⓞ].

Lever Selector Switches	Style	Operation			Part Numbers
	Round	2-position	Maintained		LA1T-2A1S
			Spring Return from Top		LA1T-21A1S
			Spring Return from Bottom		LA1T-22A1S
		3-position	Maintained		LA1T-3A2S
			Spring Return from Top		LA1T-31A2S
			Spring Return from Bottom		LA1T-32A2S
			Spring Return Two-way		LA1T-33A2S

L6 Accessories

Name & Appearance	Application/Specification	Part Numbers	Remarks	
T-branch Connector 	Connects AS-Interface flat cable to 2-wire cable	LA9Z-SNTB	Current capacity 3A For wiring instructions, see page 286.	
Hand-held Programming Device 	Assigns slave addresses and monitor system configuration	SX9Z-ADR1N	Contains: • Programming device cable (SX9Z-CN1) • Programming device AC adapter (SX9Z-ADPT) • SwitchNet addressing port adapter (LA9Z-SNADP) • Operation manual (English/Japanese)	
Programming Device Cable 	Connects programming device to slave	SX9Z-CN1	Included with hand-held programming device SX9Z-ADR1N	
Programming Device AC Adapter 	Charges programming device	SX9Z-ADPT	AC input voltage: 100-240V AC Included with hand-held programming device SX9Z-ADR1N	
SwitchNet Addressing Port Adapter 	Connects programming device cable to SwitchNet communication blocks	LA9Z-SNADP	Included with hand-held programming device SX9Z-ADR1N	
Tools	Locking Ring Wrench 	Made of nickel-plated brass	MT-001	<ul style="list-style-type: none"> Used to tighten the plastic locking ring when installing an L6 unit. Tightening torque: 0.88 N-m maximum
	Lamp Holder Tool 	Made of rubber	OR-44	Used to remove and install LED lamps.
	Lens Removal Tool 	Made of stainless steel	MT-101	Used to remove the lens or button from the operator.
Switch Guard 180° opening Spring Return 	For round/square units	AL-K6SP	<ul style="list-style-type: none"> For preventing inadvertent operation. Degree of protection: IP65 For dimensions, see page 285. 	
	For rectangular units	AL-KH6SP		

PLCs

Operator Interfaces





Automation Software

Power Supplies



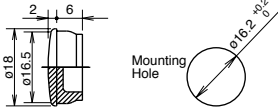

Sensors

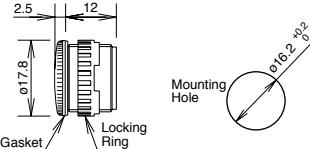
Communication & Networking

L6 Accessories

Name & Appearance		Application/Specification	Part Numbers	Remarks
	For round units		AL-D6	For minimum mounting centers when using dust proof covers, see page 286. Operating temperature: -10 to +55°C
	For square units		AL-DQ6	
	For rectangular units		AL-DH6	
	Rubber Mounting Hole Plug	Nitrile rubber (black)	AL-B6	Degree of protection: IP65 
		Metallic Mounting Hole Plug	Metal (Locking ring: plastic)	Degree of protection: IP66 

L6 Series Replacement Parts

Name and Appearance		Part Numbers	Remarks
	For round units	AB6M-BK2①	In place of ①, specify a button color code. B (black), G (green), R (red), S (blue), W (white), Y (yellow)
	For square units	AB6Q-BK2①	
	For rectangular units	AB6H-BK2①	
	For round units	AL6M-LK2②	In place of ②, specify a lens color code. A (amber), C (clear), G (green), R (red), S (blue), Y (yellow) Note: For white illumination W, use a C (clear) lens.
	For square units	AL6Q-LK2②	
	For rectangular units	AL6H-LK2②	
	For round units	AL6M-W	White
	For square units	AL6Q-W	
	For rectangular units	AL6H-W	
	For key switch	AS6-SK	Key #132
	For illuminated selector switch	LA1A-F②	In place of ②, specify a lens color code. A (amber), G (green), R (red), S (blue), W (white), Y (yellow)

LED Lamp

Rated Voltage	Current Draw	Part Numbers	Lens Color Code	Lamp Base
24V AC/DC ±10%	8mA AC/DC	LFTD-2②	A (amber), G (green), R (red), S (blue), W (white), Y (yellow) In place of ②, specify a lens color code.	T 1-3/4 Miniature flange base

PLCs

Operator Interfaces

Automation Software

Power Supplies

Sensors

Communication & Networking

Specifications

General Specifications

Operating Voltage	26.5 to 31.6V DC
Maximum Input Current	Pushbutton, selector, key selector, lever: 16mA Pilot light, illuminated pushbutton, illuminated selector: 22mA
Dielectric Strength	Between AS-Interface terminal and dead parts: 500V AC, 1 minute
Insulation Resistance	Between AS-Interface terminal and dead parts: 100 MΩ minimum (500V DC megger)
Operating Temperature	-25 to +55°C (no freezing)
Storage Temperature	-40 to +80°C (no freezing)
Operating Humidity	95% RH maximum (non-condensing)
Altitude	Operate: 2000m maximum Transport: 3000m maximum
Pollution Degree	3 (IEC60664)
Degree of Protection	IP65
Corrosion Immunity	Atmosphere free from corrosive gases
Vibration Resistance	5 to 55 Hz amplitude 0.5mm, 50 m/s ² (5G) 1 hour per axis on each of three mutually perpendicular axes
Shock Resistance	1000 m/s ² (100G), 5 shocks on each of three mutually perpendicular axes
Weight	Approx. 20g

Communication Specifications

Applicable Standard	AS-Interface Ver. 2.1
Slave Profile	I/O code/ID code/ID2 code: B/A/E
Occupied Slave Address	1 slave address
Digital I/O Data Allocation	See page 284
Illumination Control	LED illumination brightness of SwitchNet units can be controlled using the Write_Parameter command. For Write_Parameter command and settings, see page 284
AS-Interface Communication Specifications	Control system: Master/slave system Topology: Free topology Transmission medium: 2-wire cable Maximum slaves: 62 (A/B slaves), 31(standard slaves) Maximum I/O points: 434 (A/B slaves), 248 (standard slaves) Maximum network length: 100m (without repeater) Maximum bus scan time: 10ms (62 A/B slaves), 5ms (31 standard slaves)

Mechanical/Electrical Specifications

Terminal Style	Spring clamp
Applicable Wire	Parallel 2-wire cable (twisted pair cable not applicable) Single wires can also be used for connection over short distances. Stranded wire: 0.5 to 0.75mm ² (AWG20 to 18) Solid wire: 0.5 to 1.5mm ² (AWG20 to 16) Do not twist single wires together.
Mounting Centers	Vertical: 18mm, Horizontal: 24mm
Mounting Hole Size	16.2mm, +0.2 or -0mm
Applicable LED Lamp	LFTD-2Ⓢ (rated current 8mA AC/DC)
Mechanical Life	Momentary: 2,000,000 operations minimum Maintained, selector, lever: 250,000 operations minimum Addressing port adapter durability: 100 insertions/removals minimum

Certification

Certification	AS-International Association
Standards	UL listed, c-UL listed, CE marked

PLCs

Operator Interfaces

Automation Software

Power Supplies

Sensors

Communication & Networking

Digital I/O Data Allocation

Slave Unit	Used I/O	Input Data (slave send data)				Output Data (slave receive data)			
		DI3	DI2	DI1	DI0	D03	D02	D01	D00
Pushbutton	1 in	0	X1	1	1	*	—	—	—
Pilot light	1 out	0	0	1	1	*	—	—	X1
Illuminated pushbutton	1 in/1 out	0	X1	1	1	*	—	—	X1
Selector, Key selector, Lever 2-position	1 in	0	X2	1	1	*	—	—	—
Selector, Key selector, Lever 3-position	2 in	X3	X3	1	1	*	—	—	—
Illuminated selector 2-position	1 in/1 out	0	X2	1	1	*	—	—	X1
Illuminated selector 3-position	2 in/1 out	X3	X3	1	1	*	—	—	X1

- In the above table, bits marked with X1, X2 and X3 are used.
- X1: When pushbutton is pressed, input data is 1 (on). When not pressed, input data is 0 (off). When output data is 1 (on), LED is on. When output data is 0 (off), LED is off.
- X2: The input data of 2-position selector switches and 2-position lever switches depend on the operator position as shown below.
- X3: The input data of 3-position selector switches and 3-position lever switches depend on the operator position as shown below

2-position Operator			
Operator Position	<table border="1"> <tr><td>1</td><td>2</td></tr> </table>	1	2
1	2		
DI2	<table border="1"> <tr><td>0</td><td>1</td></tr> </table>	0	1
0	1		

3-position Operator				
Operator Position	<table border="1"> <tr><td>1</td><td>0</td><td>2</td></tr> </table>	1	0	2
1	0	2		
DI3	<table border="1"> <tr><td>1</td><td>0</td><td>0</td></tr> </table>	1	0	0
1	0	0		
DI2	<table border="1"> <tr><td>0</td><td>0</td><td>1</td></tr> </table>	0	0	1
0	0	1		

- Unused input bits DI3 and DI2 are 0 (off), and unused input bits DI1 and DI0 are 1 (on). Slaves ignore unused output data sent from the master.
- *: The master uses bit D03 for addressing A/B slaves.

Write_Parameter Command

0	0	A4	A3	A2	A1	A0	1	Sel P3	P2	P1	P0	PB	1
---	---	----	----	----	----	----	---	--------	----	----	----	----	---

Write_Parameter Settings

LED Brightness	Settings			Remarks
	Output Selection	Control Data		
		P2	P1	
100%	1: D00 0: D01	1	1	Default
50%		0	1	
25%		1	0	
12.50%		0	0	

Marking Plate Size and Engraving Area for Illuminated Units

Style	Marking Plate Size	Marking Area
Round	ø13.8mm	ø12mm
Square	13.8 x 13.8mm	12 x 12mm
Rectangular	13.8 x 19.8mm	12 x 18mm



Engraving depth 0.5mm maximum.

Dimensions

- Pushbutton
- Pilot Light
- Illuminated Pushbutton

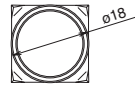
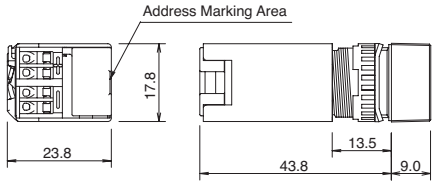
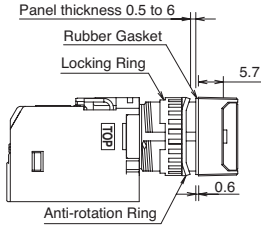

Round

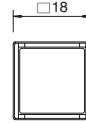

Square

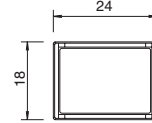

Rectangular

- Selector Switch
- Illuminated Selector Switch

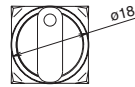
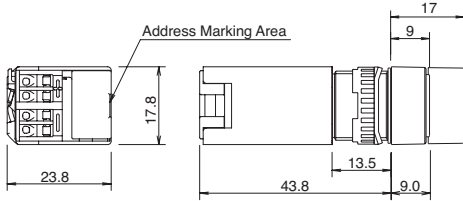
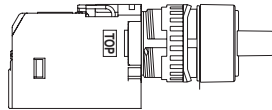

Round



Square

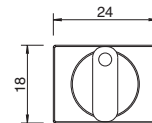

Rectangular

- Key Selector Switch

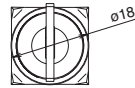
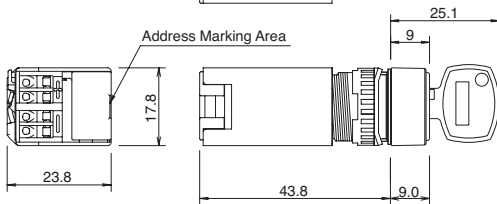
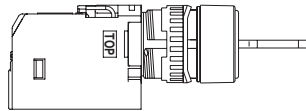

Round

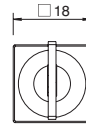

Square

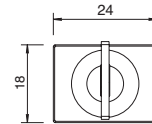

Rectangular

- Lever Switch

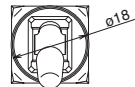
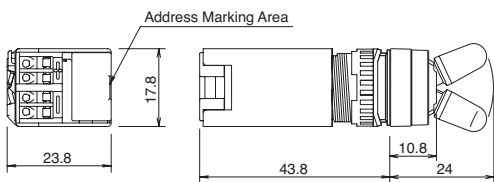
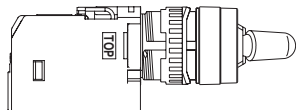

Round

PLCs

Operator Interfaces

Automation Software

Power Supplies

Sensors

Communication & Networking

Accessory Dimensions

Switch Guard

For Round/Square Units

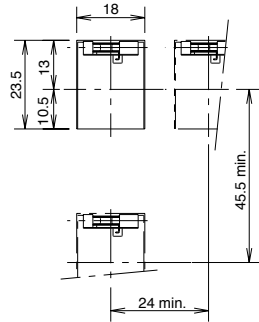

For Rectangular Units

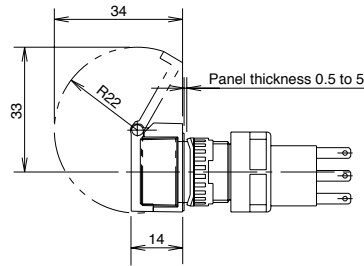
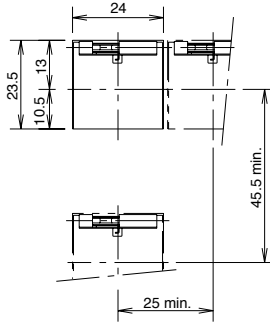

With Switch Guard Installed

Dustproof Cover

For Round Units

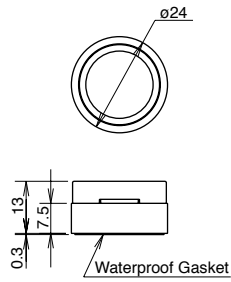

For Square Units

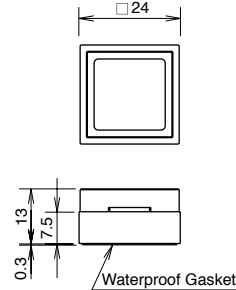

For Rectangular Units

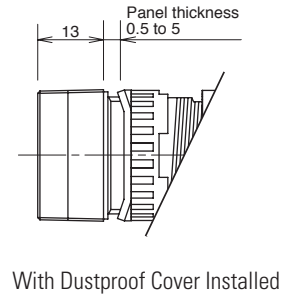
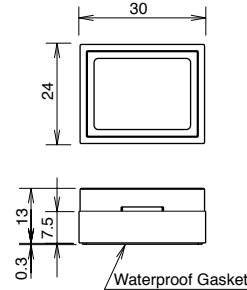

With Dustproof Cover Installed

Minimum Mounting Centers

Round/Square Units

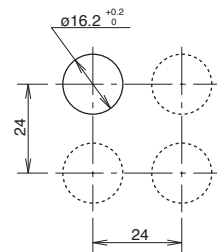

Rectangular Units

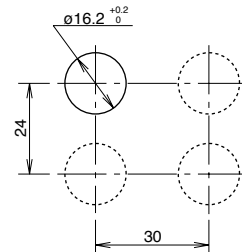

Determine the mounting centers in consideration of easy operation.
All dimensions in mm.

Wiring

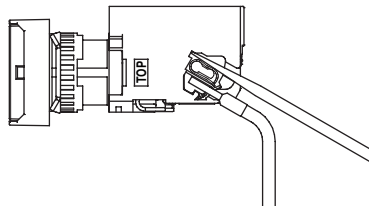
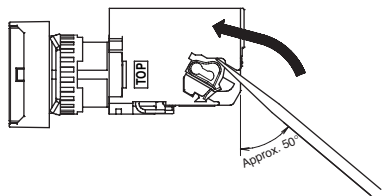

Locate the wire hole in the back of the communication contact block. To open the spring clamp in the wire hole, insert an optional screwdriver (BC1S-SD0) diagonally into the adjoining screwdriver hole until it hits the bottom. Slightly jerk the screwdriver to insert easily.

With the screwdriver held in the hole, insert a wire or ferrule to the bottom of the wire hole, then pull out the screwdriver. If an excessive force (normal operating force: 20 to 30N) is applied to the contact block while the L6 control unit is mounted on a panel, the communication block may be damaged. If the spring clamp does not open easily, remove the communication block from the operator and try again.

Applicable Screwdriver Tip

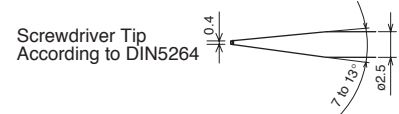

Terminal Arrangement

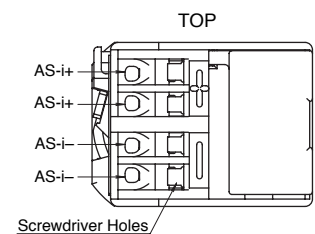

PLCs

Operator Interfaces

Automation Software

Power Supplies

Sensors

Communication & Networking

Replacement of the Lens and Marking Plate

Removal

To remove the operator (color lens, marking plate and lens holder), hold the color lens recesses with the lens removal tool (MT-101) and pull it out. Remove the marking plate by disengaging the latches between the color lens and lens holder. Engrave a legend on the correct side of the marking plate, if required.

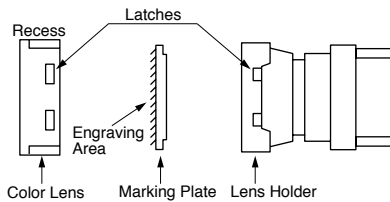

Installation

Place the marking plate on the lens holder in the correct direction and press the color lens onto the lens holder to engage the latches. Insert the lens holder into the housing in the correct direction.

Replacement of LED Lamps

Lamps can be replaced using the lamp holder tool (OR-44) from the front of the panel. The lamp can also be replaced by removing the communication block from the operator.

Replacement from Panel Front

Removal

1. Push and turn the LED lamp counterclockwise using the lamp holder tool, then the LED lamp and the lamp holder can be removed.

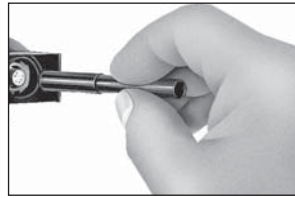

2. Push the lamp head into the lamp holder and pull out the LED lamp from the rear of the lamp holder.

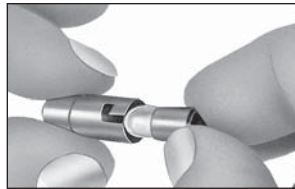

Installation

1. First, insert the LED lamp into the lamp holder from the rear. The lamp can be pushed in using the thinner end of the lamp holder tool.
2. Hold the LED lamp in the lamp holder tool as shown below.

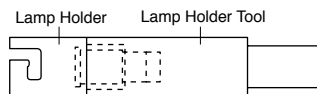

3. Insert the LED lamp into the communication block. With the slit in the lamp holder aligned with the contact pin inside, push in and turn clockwise until the lamp holder is secured.

Panel Mounting

Remove the communication block from the operator. Insert the operator into the panel cut-out from the front, then install the communication block to the operator.

Removing/Installing the Communication Block

With the yellow lever stop depressed in the direction of ①, turn the lock lever in the direction of ② (opposite to the arrow on the communication block), and pull out the communication block.

To install, align the TOP markings on the operator and the communication block together, insert the operator into the communication block and turn the lock lever in the direction of ③ (the arrow on the communication block).

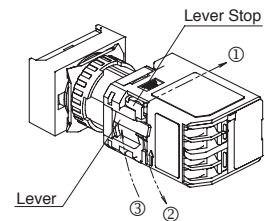

Notes for Panel Mounting

Use the optional ring wrench (MT-001) to mount the operator onto a panel. Tighten the locking ring to a recommended torque of 0.88 N·m. Use of pliers or excessive tightening will damage the locking ring.

Precautions for AS-interface Wiring (Common Notices)

1. Do not run the AS-Interface network cables in parallel with or near power lines. Keep the cables away from noise sources.
 2. Turn power off before wiring. After wiring, confirm that wiring is correct before turning power on.
 3. For wiring, use cables appropriate for each slave as listed in the table below.
- Cables applicable to slaves can also be used for the AS-Interface master module and AS-Interface power supply.
 - For SwitchNet slaves (HW and L6 units), single wires can also be used for connection over short distances: stranded wires 0.5 to 0.75mm² (AWG20 to 18) or solid wires 0.5 to 1.5mm² (AWG20 to 16).

Slave	Applicable Cable	Cable Part Numbers	Manufacturer	Remarks
SwitchNet HW/L6 all models SX5A AS-Interface I/O Module IP20 type	2-core parallel cable			
SX5A AS-Interface I/O Module all models	AS-Interface Flat Cable	Yellow (data and power)	2170 228	LAPP Sheath material: EPDM
		Black (auxiliary power)	2170 229	

Do not use twisted pair cables and do not twist single cables together.

4. When using a ferrule on a stranded wire for wiring SwitchNet slaves (HW and L6 units) or T-branch connectors, use ferrules in table below. If a stranded wire of 0.75mm² or AWG18 is connected without using a ferrule, the wire strength decreases.

Cable Size (Stranded Wire)	Ferrule Type (Phoenix Contact)	Order No.	Pcs./Pkt.
0.5mm ² (AWG20)	AI 0.5-8 WH	32 00 01 4	100
0.75mm ² (AWG18)	AI 0.75-8 GY	32 00 51 9	100

5. The maximum total cable length is 100m, including all network cables. The maximum cable length can be extended to 200m using one repeater, or to 300m using two repeaters.
6. AS-Interface does not require a terminator.
7. Slave module address default is set to 00 on shipment from factory.
8. Network error causes include:
 - Disconnected or shorted network cable
 - Strong external noise
 - Dropped power voltage for the master and slaves below the minimum power voltage.
 - Use of improper network cables

PLCs

Operator Interfaces

Automation Software

Power Supplies

Sensors

Communication & Networking