

13 12 11 10 9 8 7 6 5 4 3 2 1

J
I
H
G
F
E
D
C
B
A

J
I
H
G
F
E
D
C
B
A

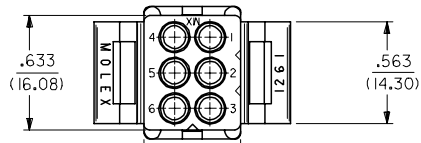

CIRCUIT I.D. (3 PL.)

OPTIONAL MOUNTING EAR (PREBENT SHOWN) & RIB, SEE DETAIL 3 & 4

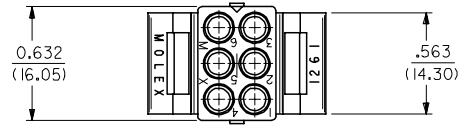
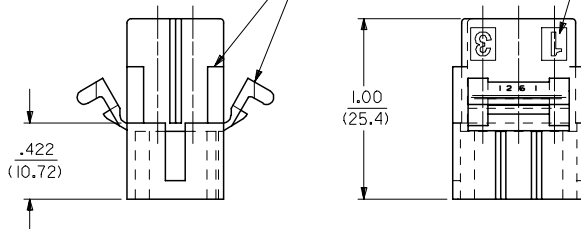

OPTIONAL MOUNTING EAR (PREBENT SHOWN) SEE DETAIL 3 & 4

OPTIONAL LOCK RAMP

CIRCUIT I.D. (3 PL.)

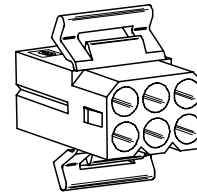
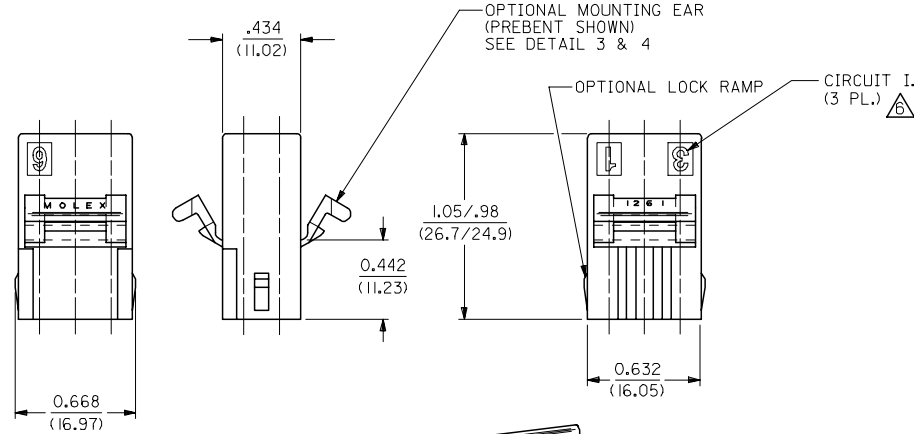

RECEPTACLE

.198±.005 (5.03±0.13)

.198±.005 (5.03±0.13) (2 PL.)

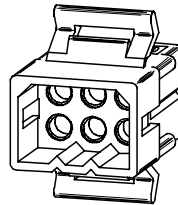
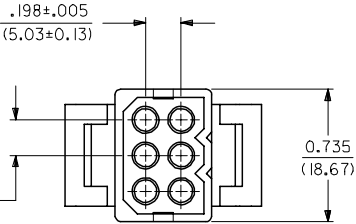

PLUG

.198±.005 (5.03±0.13)

.198±.005 (5.03±0.13) (2 PL.)

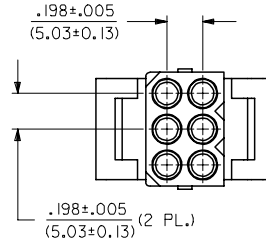

REVISED NOTES EC NO: UCP2006-2424 DRAWN/PRI/DOR 2006/06/08 CHKD: AEL/HAG 2006/06/08 APPR: FSM/TH 2006/06/09	QUALITY SYMBOLS ▽=0 ▽=0	GENERAL TOLERANCES (UNLESS SPECIFIED)		DIMENSION STYLE IN/MM	SCALE 2:1	DESIGN UNITS INCH	THIRD ANGLE PROJECTION	
		mm	INCH	DRAWN BY GWC	DATE 11/6/89	TITLE .093/(2.36) HOUSING, PLUG AND RECEPTACLE, 6 CKT., .198/(5.03)CTRS.		
		4 PLACES ± --- ± ---	± .007	CHECKED BY RW	DATE 11/6/89	MATERIAL NO. SD-1261-*		
		3 PLACES ± --- ± .10	± .10	APPROVED BY GWF	DATE 11/6/89	DOCUMENT NO. MOLEX INCORPORATED		
2 PLACES ± 0.25 ± ---	± ---	ANGULAR ± 2 °		SIZE C	SEE CHART	SHEET NO. 1 OF 2	A	
DRAFT WHERE APPLICABLE MUST REMAIN WITHIN DIMENSIONS		THIS DRAWING CONTAINS INFORMATION THAT IS PROPRIETARY TO MOLEX INCORPORATED AND SHOULD NOT BE USED WITHOUT WRITTEN PERMISSION						

12 11 10 9 8 7 6 5 4 3 2 1

PLUG

PART NO.	ENG. NO.
03-09-2061	I261-P
23-09-2061	I261-P-100
03-09-2062	I261-P1
23-09-2062	I261-P1-100
03-09-7061	I261-PBK
03-09-7062	I261-PIBK
27-09-2093	I261-PI-200
50-29-0099	I261-PI-300

RECEPTACLE

PART NO.	ENG. NO.
03-09-1061	I261-R
23-09-1061	I261-R-100
03-09-1062	I261-R1
23-09-1062	I261-R1-100
03-09-1063	I261-R2
23-09-1063	I261-R2-100
03-09-1064	I261-R3
27-09-1063	I261-R2-200
03-09-6064	I261-R3BK
03-09-6063	I261-R2BK
03-09-6062	I261-RIBK
03-09-6061	I261-RBK
50-29-1500	I261-R3-300

LEGEND: PLUG

I261-P***-***

P = PLUG

BLANK = PLUG WITH PREBENT MOUNTING EARS

I = PLUG WITHOUT MOUNTING EARS

COLOR: BLANK=NATURAL COLOR

AM=AMBER BK=BLACK BU=BLUE
 BN=BROWN GY=GRAY GN=GREEN
 OR=ORANGE RD=RED YW=YELLOW

MATERIAL: BLANK = NYLON 6/6, U.L. 94V-2
 100 = POLYPROPYLENE, U.L. 94V-0
 200 = NYLON 6/6, U.L. 94V-0, RED
 300 = NYLON 6/6, U.L. 94V-2, BLACK
 UV RESISTANT

LEGEND: RECEPTACLE

I261-R***-***

R = RECEPTACLE

BLANK = WITH STD. MOUNTING EARS, WITH LOCK RAMPS

1 = WITH STD. MOUNTING EARS, WITHOUT LOCK RAMPS

2 = WITHOUT MOUNTING EARS, WITHOUT LOCK RAMPS

3 = WITHOUT MOUNTING EARS, WITH LOCK RAMPS

4 = WITH PREBENT MOUNTING EARS, WITH LOCK RAMPS

5 = WITH PREBENT MOUNTING EARS, WITHOUT LOCK RAMPS

COLOR: BLANK=NATURAL COLOR

AM=AMBER BK=BLACK BU=BLUE
 BN=BROWN GY=GRAY GN=GREEN
 OR=ORANGE RD=RED YW=YELLOW

MATERIAL: BLANK = NYLON 6/6, U.L. 94V-2
 100 = POLYPROPYLENE, U.L. 94V-0
 200 = NYLON 6/6, U.L. 94V-0, RED
 300 = NYLON 6/6, U.L. 94V-2, BLACK
 UV RESISTANT

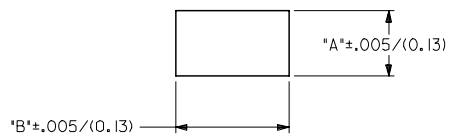
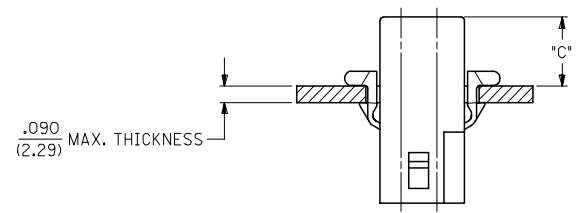

MOUNTING HOLE CUTOUT

HOUSING	DIM. "A"	DIM. "B"	DIM. "C" (STD. EAR)	DIM. "C" (PREBENT)
PLUG	.750/(19.05)	.695/(17.65)	.39/(9.9)	.40/(10.1)
RECEPTACLE	.718/(18.24)	.600/(15.24)	.40/(10.1)	.41/(10.3)

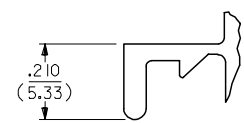

DETAIL 3

.093/(2.36) STANDARD MOUNTING EAR
(SCALE 4:1)

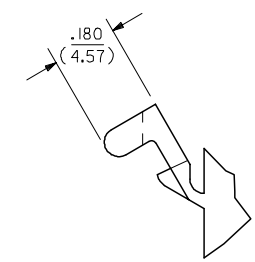
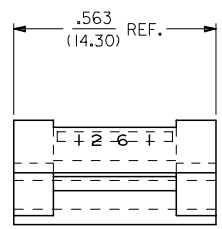

DETAIL 4

.093/(2.36)PREBENT MOUNTING EAR
(SCALE 4:1)

NOTES:

- MATERIAL: SEE LEGEND
- FINISH: NONE.
- PROUCT SPECIFICATION: PS-43660-9999
- PACKAGING INFORMATION: PK-1261-001
- HOUSINGS FOR USE WITH MOLEX .093/(2.36) PIN AND SOCKET TERMINALS.
- CIRCUIT I.D. NUMBERS ON SIDE OF HOUSING APPEAR ON PARTS FROM TOOLS BUILT AFTER 9/3/91.
- WHERE DENOTED IN CHART, TOOLS ARE BUILT WITH PREBENT MOUNTING EARS PER DETAIL 4 AND SUPERSEDE ALL TOOLS PREVIOUSLY BUILT WITH THE STANDARD MOUNTING EAR.
- TEXT AND CIRCUIT IDENTIFIERS ARE SHOWN IN APPROXIMATE LOCATION BUT MAY VARY TO ACCOMMODATE TOOLING.

UPDATED NOTES EC NO: UCP2006-2424 DRAWN: P1 DDER 2006/06/08 CHKD: AELHAG 2006/06/08 APPR: FSM TH 2006/06/09 X3	QUALITY SYMBOLS ▽=0 ▽=0	GENERAL TOLERANCES (UNLESS SPECIFIED)		DIMENSION STYLE IN/MM		SCALE 4:1	DESIGN UNITS INCH	THIRD ANGLE PROJECTION	
		4 PLACES ± --- ± --- 3 PLACES ± --- ± .007 2 PLACES ± 0.18 ± .010 1 PLACE ± 0.25 ± --- ANGULAR ± 2 °	DRAWN BY GWF DATE 11/10/89	CHECKED BY RW DATE 11/10/89	APPROVED BY GWF DATE 11/10/89	.093/(2.36) HOUSING, PLUG AND RECEPTACLE, 6 CKT., .198/(5.03) CTRS.			
		DRAFT WHERE APPLICABLE MUST REMAIN WITHIN DIMENSIONS		SEE CHART		MATERIAL NO. SD-1261-*		MOLEX INCORPORATED	

THIS DRAWING CONTAINS INFORMATION THAT IS PROPRIETARY TO MOLEX INCORPORATED AND SHOULD NOT BE USED WITHOUT WRITTEN PERMISSION