

80SQ... SERIES

SCHOTTKY RECTIFIER

8 Amp

Major Ratings and Characteristics

Characteristics	80SQ...	Units
$I_{F(AV)}$ Rectangular waveform	8	A
V_{RRM} range	35 to 45	V
I_{FSM} @ $t_p = 5 \mu s$ sine	2400	A
V_F @ 8Apk, $T_J = 125^\circ C$	0.44	V
T_J range	-55 to 175	$^\circ C$

Description/Features

The 80SQ axial leaded Schottky rectifier series has been optimized for low reverse leakage at high temperature. The proprietary barrier technology allows for reliable operation up to 175°C junction temperature. Typical applications are in switching power supplies, converters, free-wheeling diodes, and reverse battery protection.

- 175° C T_J operation
- High purity, high temperature epoxy encapsulation for enhanced mechanical strength and moisture resistance
- Low forward voltage drop
- High frequency operation
- Guard ring for enhanced ruggedness and long term reliability

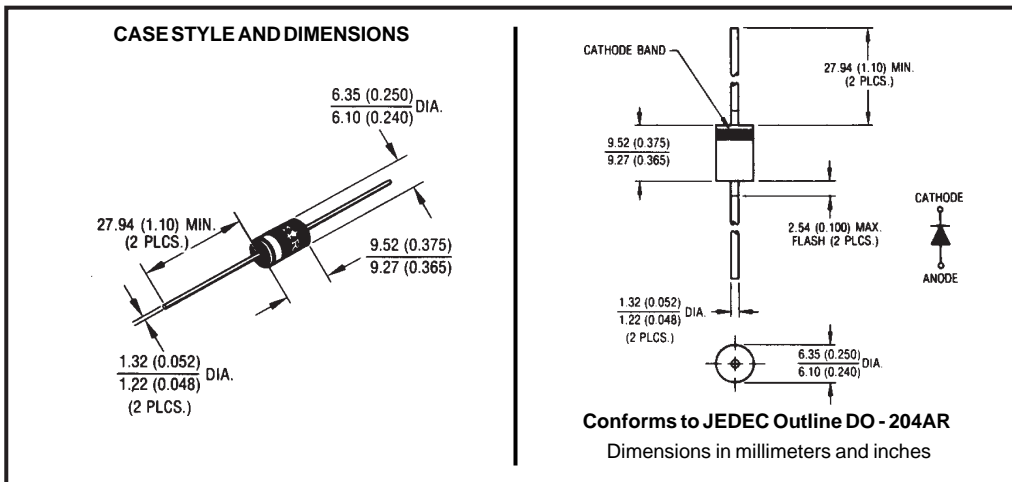

Voltage Ratings

Part number	80SQ035	80SQ040	80SQ045
V_R Max. DC Reverse Voltage (V)	35	40	45
V_{RWM} Max. Working Peak Reverse Voltage (V)			

Absolute Maximum Ratings

Parameters	80SQ	Units	Conditions
$I_{F(AV)}$ Max. Average Forward Current * See Fig. 5	8	A	50% duty cycle @ $T_C = 119^\circ\text{C}$, rectangular wave form
I_{FSM} Max. Peak One Cycle Non-Repetitive Surge Current * See Fig. 7	2400	A	Following any rated load condition and with rated V_{RWM} applied
	380		
E_{AS} Non-Repetitive Avalanche Energy	10	mJ	$T_J = 25^\circ\text{C}$, $I_{AS} = 1.6$ Amps, $L = 7.8$ mH
I_{AR} Repetitive Avalanche Current	1.6	A	Current decaying linearly to zero in 1 μsec Frequency limited by T_J max. $V_A = 1.5 \times V_R$ typical

Electrical Specifications

Parameters	80SQ	Units	Conditions
V_{FM} Max. Forward Voltage Drop (1) * See Fig. 1	0.53	V	@ 8A
	0.60	V	@ 16A
	0.44	V	@ 8A
	0.55	V	@ 16A
I_{RM} Max. Reverse Leakage Current (1) * See Fig. 2	2	mA	$T_J = 25^\circ\text{C}$
	15	mA	$T_J = 125^\circ\text{C}$
C_T Max. Junction Capacitance	900	pF	$V_R = 5V_{DC}$, (test signal range 100Khz to 1Mhz) 25°C
L_S Typical Series Inductance	10.0	nH	Measured lead to lead 5mm from body
dv/dt Max. Voltage Rate of Change (Rated V_R)	10,000	V/ μs	

(1) Pulse Width < 300 μs , Duty Cycle < 2%

Thermal-Mechanical Specifications

Parameters	80SQ	Units	Conditions
T_J Max. Junction Temperature Range	-55 to 175	$^\circ\text{C}$	
T_{stg} Max. Storage Temperature Range	-55 to 175	$^\circ\text{C}$	
R_{thJL} Max. Thermal Resistance Junction to Lead	8.0	$^\circ\text{C/W}$	DC operation * See Fig. 4 1/8 inch lead length
R_{thJA} Typical Thermal Resistance, Junction to Air	44	$^\circ\text{C/W}$	
wt Approximate Weight	1.4(0.049)	g(oz.)	
Case Style	DO - 204AR		JEDEC

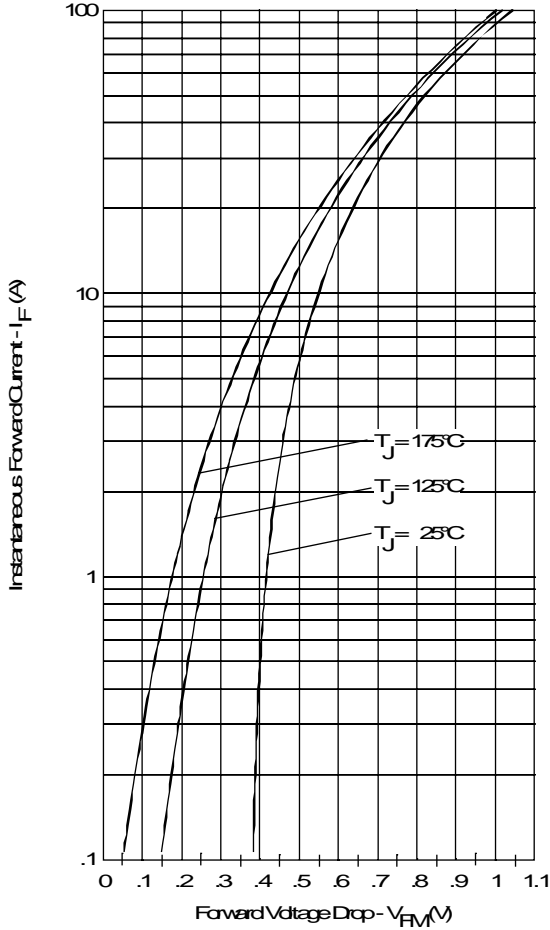

Fig. 1 - Maximum Forward Voltage Drop Characteristics

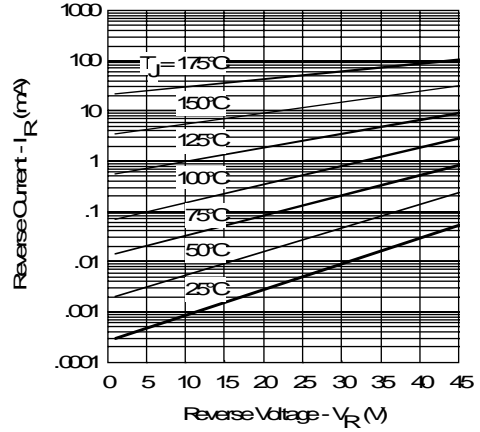

Fig. 2 - Typical Values of Reverse Current Vs. Reverse Voltage

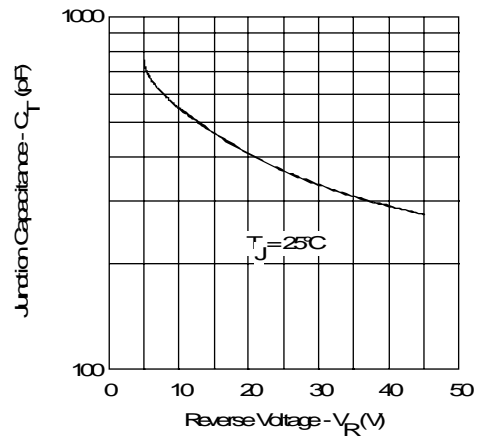

Fig. 3 - Typical Junction Capacitance Vs. Reverse Voltage

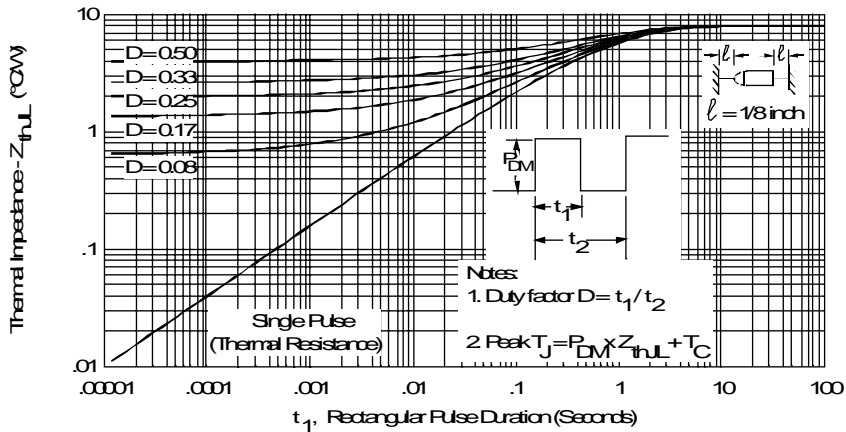

Fig. 4 - Maximum Thermal Impedance Z_{thJL} Characteristics

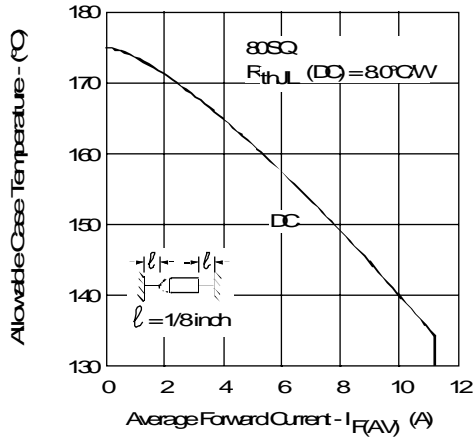

Fig. 5 - Maximum Allowable Case Temperature Vs. Average Forward Current

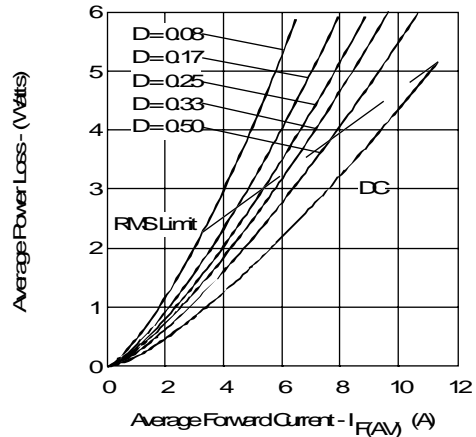

Fig. 6 - Forward Power Loss Characteristics

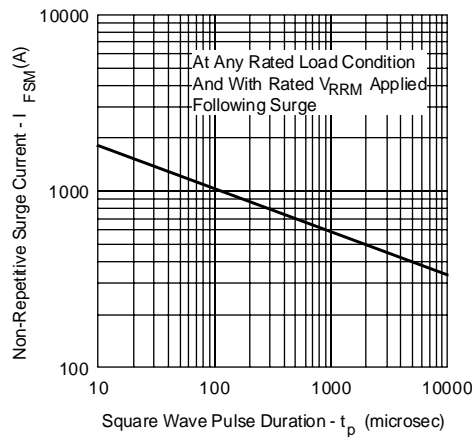

Fig. 7 - Maximum Non-Repetitive Surge Current

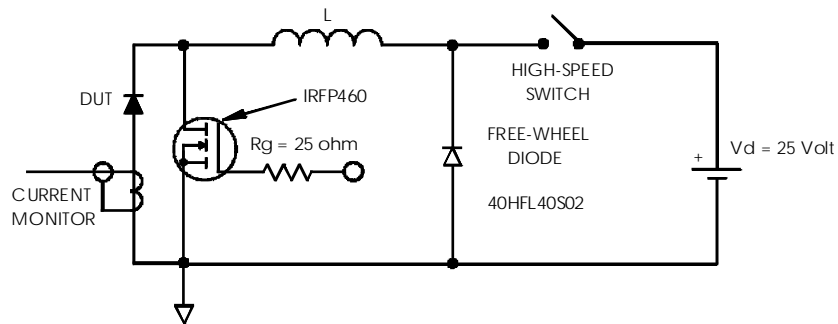

Fig. 8 - Unclamped Inductive Test Circuit